



## **GALAKSI VISION**

**2022 - 2023**

**Professional LED Lighting Fixtures**

**Luminaires Professionnels LED**

## MODERN LIGHTING FIXTURES LUMINAIRES MODERNES



Factory / Usine

KONYA/TURKEY



## ABOUT US

PAMIR ELEKTRİK is located in the industrial city of KONYA, in the heart of Anatolia.

Created in 1974, it was manufacturing originally some electrical equipment. However, since 1990, it shifted its production solely towards the lighting sector, and became a specialist in this field.

It ranks today among the most performing Turkish companies in the sector, which offer a large array of products, combining aesthetic, quality and competitive price.

Range of products:

- LED and T5 Fluorescent lighting fixtures for offices and shopping places,
- IP67 LED Floodlights & High bay lights,
- IP65 LED and T5 Fluorescent High bay lighting fixtures,
- IP65 LED and T5, T8 Fluorescent Waterproof lighting fixtures,
- IP65 LED and T5, T8 Fluorescent ExProof lighting fixtures,
- Wallwashers,
- Downlights, track lights,
- Glop lamps,
- Motion sensor,
- Motion sensor lamps,

Our strengths:

PAMIR's catalogue offers a large variety of Elegant lighting fixtures, Proline lighting fixtures, circular lighting fixtures, wall lamps, waterproof lighting fixtures, motion sensor lamps... and accessories to be fitted either on the ceiling (suspended, recessed or surface mounted), or on the wall, all made with the finest materials and craftsmanship available.

We are able to conceive and offer products which combine both aesthetic and competitiveness, due to the fact that all the different stages – from conception to production are done in our factory.

All products are thought in our R&D department, by means of the latest softwares CAD/CAM and others, the moulds prepared in our own mould workshop, then once tested and approved, manufactured.

Every order – be it small or large – gets our personal attention and care down to the smallest details.

Whatever your lighting need may be, let us care for it. We have been in the business for nearly 40 years, and the repeated orders from our faithful clients both in Turkey and abroad are the best testimony for our quality and seriousness.

We will be very honoured to get to know you and serve you.

## NOUS CONNAITRE

PAMIR ELEKTRİK est située dans la ville industrielle de KONYA, en plein centre de l'Anatolie.

Créée en 1974, elle produisait à l'origine des équipements électriques. Cependant, depuis 1990, elle s'est orientée exclusivement vers la fabrication de produits et accessoires d'éclairage.

Elle compte aujourd'hui parmi les entreprises turques les plus performantes et celles qui offrent une gamme de produits variés, alliant esthétique, qualité et prix.

Gamme de produits:

- Luminaires LED et Fluorescent T5 pour bureaux et commerces,
- Projecteurs à LED IP67 et luminaires grande hauteur,
- Appareils d'éclairage IP65 LED et T5 Fluorescent High bay,
- Luminaires LED IP65 et T5, T8 Fluorescent Waterproof,
- Luminaires IP65 LED et T5, T8 Fluorescent ExProof,
- Lèche-murs
- Spots encastrés, éclairages sur rail,
- Lampes Glop,
- Capteur de mouvement,
- Lampes à détecteur de mouvement,

Nos atouts:

Le catalogue de PAMIR montre une large gamme de luminaires, luminaires étanches, hublots avec détecteur de mouvement, hublots, appliques... et accessoires, suspendus et/ou encastrés à fixer au plafond, des appliques et hublots muraux, ... tous fabriqués avec des matières premières de qualité et une expertise hors pair.

Grace à l'existence au sein de la société des différentes étapes de conception et de fabrication, nous sommes en mesure de penser des produits qui allient aussi bien l'esthétique, la qualité, mais également la compétitivité.

Tous les produits sont conçus dans notre département R&D, avec l'utilisation des logiciels CAD/CAM et autres, les moules réalisés dans notre propre atelier de moulage, puis une fois testés et approuvés, fabriqués.

Chaque commande – petite ou grande – bénéficie de notre attention jusqu'au moindre détail.

Quels que soient vos besoins en éclairage, laissez nous le soin de les prendre en charge. Nous sommes dans le domaine depuis près de 40 ans, et les commandes répétées de nos fidèles clients, tant en Turquie qu'à l'Étranger, sont la meilleure preuve de notre qualité et sérieux.

Nous serons très honorés de vous connaître et de vous servir.

**GALAKSI**

**SF-08**  
PAGE



**ELITE**

**SF-52**  
PAGE



**PRIZMA**

**SF-68**  
PAGE



**FAST LINE**

**SF-76**  
PAGE



**VEGA**

**SF-82**  
PAGE



**OPTIMUM**

**SF-100**  
PAGE



**VEGA SLIM**

**SF-108**  
PAGE



**SIMETRI**

**SF-118**  
PAGE



**SIMETRI SLIM**

**SF-124**  
PAGE



**FLEKSI**

**SF-132**  
PAGE



**ELEGANT**

**SF-138**  
PAGE

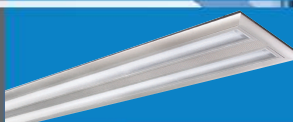

**APPLIQUE**

**SF-146**  
PAGE



**COVE LIGHT**

**SF-152**  
PAGE

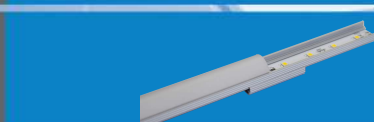

**QUADRO**

**SF-156**  
PAGE



**SURFACE MOUNTED**

**SF-160**  
PAGE



**STERILE / STÉRILE**

**SF-164**  
PAGE



**RECESSED BACK-LIGHT** SF-170  
PAGE

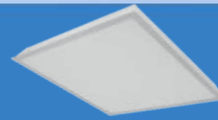

**CLIP-IN BACK-LIGHT** SF-178  
PAGE



**TRIM LINE** SF-182  
PAGE



**ASYMMETRIC** SF-186  
PAGE



**V-LINE RECESSED** SF-192  
PAGE



**SLIM LINE** SF-196  
PAGE

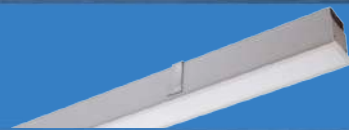

**PROLINE** SF-200  
PAGE



**WALLWASHER** SF-206  
PAGE



**RADIANT** SF-210  
PAGE



**INDUSTRIAL / INDUSTRIEL** SF-220  
PAGE



**WATERPROOF & EX-PROOF** SF-226  
PAGE



**TRACK LIGHT** SF-248  
PAGE



**DOWNLIGHT** SF-258  
PAGE



**METAL GLOP** SF-282  
PAGE



**SENSOR** SF-286  
PAGE



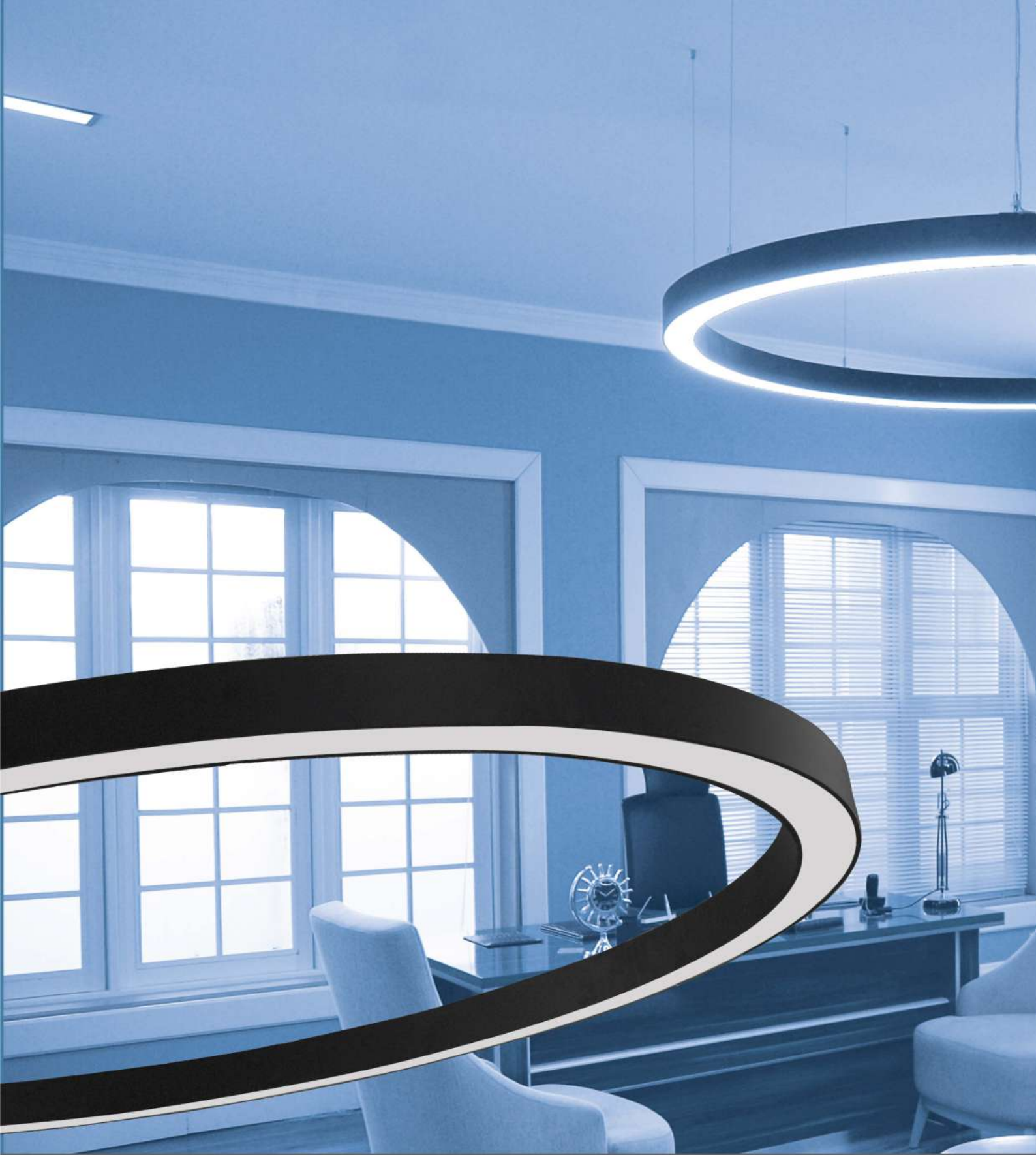

 **pamir**<sup>®</sup>  
aydınlatma





**GALAKSI**





# GALAKSI FREEDOM

## LED

### Suspended Lighting Fixtures With Frosted Diffuser

### Luminaire suspendus Avec Diffuseur Givré

#### APPLICATION AREAS

Shopping Malls  
Supermarkets  
Offices  
Meeting rooms  
Stores  
Hospitals  
Schools  
Corridors

#### DOMAINES D'UTILISATION

Centres Commerciaux  
Supermarchés  
Bureaux  
Salles de Réunions  
Magasins  
Hopitaux  
Ecoles  
Couloirs

#### BODY

Anodized aluminum with satin finishing. Black and white color options with elegant design.

#### DIFFUSER

UV stabilized frosted diffuser.

#### CONVERTER

Long life, low power loss converter with constant current. Compatible with ENEC standards.

#### LED

LED modules with 60.000 hours lifetime LUMILEDS / SAMSUNG / NICHIA brand LEDs.

#### SUSPENSION

Composed of 1mm steel wire rope and nickel-plated brass components. Suspension height is adjustable. Supplied with transparent electric cord and ceiling mounted electrical junction box with aesthetic design.

#### CORPS

Corps en aluminium anodisé, satiné. Design élégant. Couleurs blanc, noir disponibles.

#### DIFFUSEUR

Diffuseur givré. Anti UV.

#### CONVERTEUR

Convertisseur, conforme aux normes ENEC. Longue vie. Perte de puissance faible avec courant constant.

#### LED

Modules LED – Durée de vie 60.000 heures avec LED de marque LUMILEDS / SAMSUNG / NICHIA.

#### SYSTEME DE FIXATION

Composé d'un fil en acier de 1mm, de composants en laiton nickelés. Livré avec un cordon électrique transparent et une boîte de jonction électrique à fixer au plafond. Hauteur de fixation réglable.

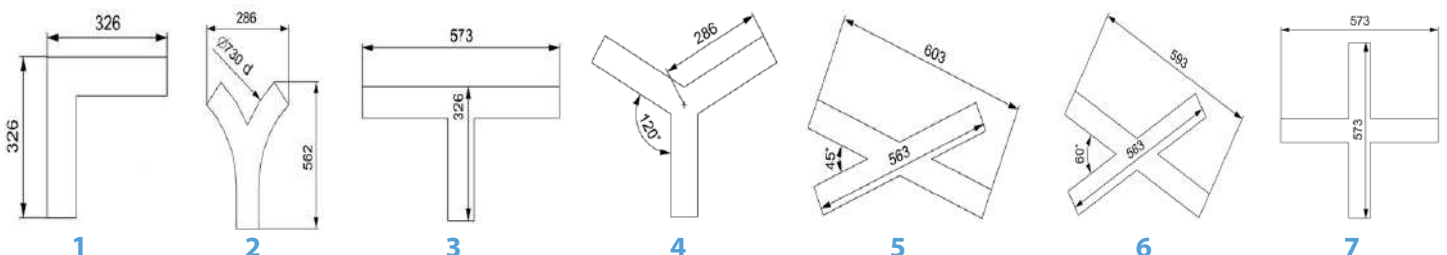

Color Options  
Options de Couleur



LED Type / Type LED

Color Rendering Index / Indice de Rendu des Couleurs: (CRI): Ra>80

Code	Power Puissance (W)	LED Type Type De LED	LED Module Module LED	Lum. Flux Flux Lum. (lm)	Color Temperature Température De Couleur (K)	Dimensions (mm)			Weight Poids (kg)	Shape La Forme
						a	d	h		
PL8S180F3L15C	21	2835 SMD	PCB	1910	2700 - 6500	79	620	89	1,9	
PL8S180F4L15C	26	2835 SMD	PCB	2550	2700 - 6500	79	800	89	2,6	
PL8S180F5L15C	33	2835 SMD	PCB	3185	2700 - 6500	79	980	89	3,3	
PL8S180F6L15C	39	2835 SMD	PCB	3820	2700 - 6500	79	1155	89	3,9	
PL8S180F8L15C	53	2835 SMD	PCB	5095	2700 - 6500	79	1500	89	5,1	
PL8S180F10L15C	66	2835 SMD	PCB	6365	2700 - 6500	79	1890	89	5,9	
PL8S180F12L15C	79	2835 SMD	PCB	7640	2700 - 6500	79	2255	89	6,7	
PL8S180F14L15C	92	2835 SMD	PCB	8915	2700 - 6500	79	2610	89	7,7	
PL8S180F16L15C	105	2835 SMD	PCB	10185	2700 - 6500	79	2950	89	8,6	
PL8S90F2L15C	14	2835 SMD	PCB	1275	2700 - 6500	79	800	89	1,5	
PL8S90F3L15C	21	2835 SMD	PCB	1910	2700 - 6500	79	1155	89	2,0	
PL8S90F4L15C	26	2835 SMD	PCB	2550	2700 - 6500	79	1500	89	2,6	
PL8S90F5L15C	33	2835 SMD	PCB	3185	2700 - 6500	79	1890	89	3,3	
PL8S90F6L15C	39	2835 SMD	PCB	3820	2700 - 6500	79	2255	89	3,9	
PL8S90F7L15C	47	2835 SMD	PCB	4455	2700 - 6500	79	2610	89	4,5	
PL8S90F8L15C	53	2835 SMD	PCB	5095	2700 - 6500	79	2950	89	5,1	
PL8S90F9L15C	60	2835 SMD	PCB	5730	2700 - 6500	79	3315	89	5,5	
PL8S90F10L15C	66	2835 SMD	PCB	6365	2700 - 6500	79	3675	89	5,9	
PL8S45F1L15C	8	2835 SMD	PCB	640	2700 - 6500	79	800	89	1,5	
PL8S45F2L15C	14	2835 SMD	PCB	1275	2700 - 6500	79	1500	89	1,5	
PL8S45F3L15C	21	2835 SMD	PCB	1910	2700 - 6500	79	2255	89	2,0	
PL8S45F4L15C	26	2835 SMD	PCB	2550	2700 - 6500	79	2950	89	2,6	
PL8S45F5L15C	33	2835 SMD	PCB	3190	2700 - 6500	79	3675	89	3,3	
Code	Power Puissance (W)	LED Type Type De LED	LED Module Module LED	Lum. Flux Flux Lum. (lm)	Color Temperature Température De	Dimensions (mm)			Weight Poids (kg)	Shape La Forme
PL8SLF1L15C	8	2835 SMD	PCB	640	2700 - 6500	79	282	89	1,5	
PL8SLF2L15C	14	2835 SMD	PCB	1275	2700 - 6500	79	565	89	1,5	
PL8SLF3L15C	21	2835 SMD	PCB	1910	2700 - 6500	79	845	89	2,0	
PL8SLF4L15C	26	2835 SMD	PCB	2550	2700 - 6500	79	1125	89	2,6	
PL8SLF5L15C	33	2835 SMD	PCB	3185	2700 - 6500	79	1405	89	3,3	
PL8SLF6L15C	39	2835 SMD	PCB	3820	2700 - 6500	79	1685	89	3,9	
PL8SLF7L15C	47	2835 SMD	PCB	4455	2700 - 6500	79	1965	89	4,5	
PL8SLF8L15C	53	2835 SMD	PCB	5095	2700 - 6500	79	2254	89	5,1	
PL8SLF9L15C	60	2835 SMD	PCB	5730	2700 - 6500	79	2525	89	5,5	
PL8SLF10L15C	66	2835 SMD	PCB	6365	2700 - 6500	79	2810	89	5,9	
Code	Power Puissance (W)	LED Type Type De LED	LED Module Module LED	Lum. Flux Flux Lum. (lm)	Color Temperature Température De	Dimensions (mm)		Weight Poids (kg)	Shape La Forme	
PL8SCF2L15C	14	2835 SMD	PCB	1275	2700 - 6500	79	89	1,5	1	
PL8SAF3L15C	21	2835 SMD	PCB	1910	2700 - 6500	79	89	2,0	2	
PL8STF3L15C	21	2835 SMD	PCB	1910	2700 - 6500	79	89	2,0	3	
PL8SYF3L15C	21	2835 SMD	PCB	1910	2700 - 6500	79	89	2,0	4	
PL8S45KF4L15C	26	2835 SMD	PCB	2550	2700 - 6500	79	89	2,6	5	
PL8S60KF4L15C	26	2835 SMD	PCB	2550	2700 - 6500	79	89	2,6	6	
PL8S90KF4L15C	26	2835 SMD	PCB	2550	2700 - 6500	79	89	2,6	7	



# GALAKSI O DIRECT / INDIRECT

## LED

Suspended Lighting Fixtures With Frosted Diffuser

Luminaire Suspendus Avec Diffuseur Givré

### APPLICATION AREAS

Shopping Malls  
Supermarkets  
Offices  
Meeting rooms  
Stores  
Hospitals  
Schools  
Corridors

### DOMAINES D'UTILISATION

Centres Commerciaux  
Supermarchés  
Bureaux  
Salles de Réunions  
Magasins  
Hopitaux  
Ecoles  
Couloirs

#### BODY

Anodized aluminum with satin finishing. Black and white color options with elegant design.

#### DIFFUSER

UV stabilized frosted diffuser.

#### CONVERTER

Long life, low power loss converter with constant current. Compatible with ENEC standards.

#### LED

LED modules with 60.000 hours lifetime LUMILEDS / SAMSUNG / NICHIA brand LEDs.

#### SUSPENSION

Composed of 1mm steel wire rope and nickel-plated brass components. Suspension height is adjustable. Supplied with transparent electric cord and ceiling mounted electrical junction box with aesthetic design.

#### CORPS

Corps en aluminium anodisé, satiné. Design élégant. Couleurs blanc, noir disponibles.

#### DIFFUSEUR

Diffuseur givré. Anti UV.

#### CONVERTEUR

Convertisseur, conforme aux normes ENEC. Longue vie. Perte de puissance faible avec courant constant.

#### LED

Modules LED – Durée de vie 60.000 heures avec LED de marque LUMILEDS / SAMSUNG / NICHIA.

#### SYSTEME DE FIXATION

Composé d'un fil en acier de 1mm, de composants en laiton nickelés. Livré avec un cordon électrique transparent et une boîte de jonction électrique à fixer au plafond. Hauteur de fixation réglable.

Indirect Lighting  
Éclairage Indirect

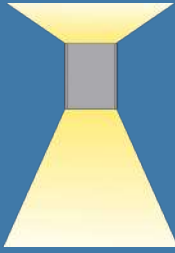

Direct Lighting  
Éclairage Direct



Color Options  
Options de Couleur



LED Type / Type LED

Color Rendering Index / Indice de Rendu des Couleurs: (CRI): Ra>80

Kod Code	Power Puissance (W)	LED Type Type De LED	LED Module Module LED	Lum. Flux Flux Lum. (lm)	Color Temperature Température De Couleur (K)	Dimensions (mm)			Weight Poids (kg)	Packing Quantity Colisage	Pcs./20" Container Pcs./20" Conteneur
						a	d	h			
PL8ES06L15C	39/18	2835 SMD	PCB	3880 / 1405	2700 - 6500	79	620	73	3,9	1	550
PL8ES08L15C	53/21	2835 SMD	PCB	5170 / 1685	2700 - 6500	79	800	73	5,1	1	340
PL8ES010L15C	66/28	2835 SMD	PCB	6460 / 2250	2700 - 6500	79	980	73	6,5	1	230
PL8ES012L15C	79/35	2835 SMD	PCB	7755 / 2810	2700 - 6500	79	1155	73	7,7	1	165
PL8ES014L15C	92/39	2835 SMD	PCB	9045 / 3090	2700 - 6500	79	1335	73	8,9	1	125
PL8ES016L15C	105/46	2835 SMD	PCB	10340 / 3650	2700 - 6500	79	1500	73	10,1	1	100
PL8ES020L15C	132/57	2835 SMD	PCB	13300 / 4495	2700 - 6500	79	1890	73	11,3	1	63



In-Direct Side LED Type / Type de LED Côté Indirecte

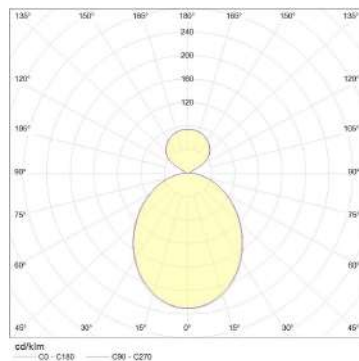
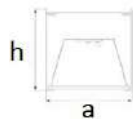
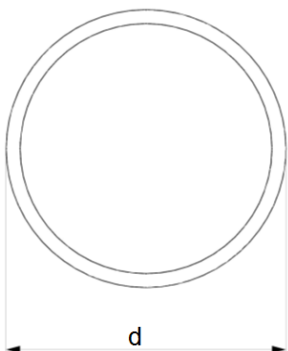

V / Hz 220 - 240 / 50 - 60

Options	Options
Dimmable electronic ballast or convertor. Emergency kit	Ballast électronique dimmable ou converteur. Kit d'urgence.
NOTE	NOTE
Given lumen values are net delivered luminaire output lumens.	Les valeurs de lumens données sont les lumens de sortie nets du luminaire.
Given power values are total consumed AC power of the luminaire.	Les valeurs de puissance données sont la puissance AC totale consommée du luminaire.



# GALAKSI O DIRECT

## LED

### Suspended Lighting Fixtures With Frosted Diffuser

### Luminaire Suspendus Avec Diffuseur Givré

#### APPLICATION AREAS

Shopping Malls  
Supermarkets  
Offices  
Meeting rooms  
Stores  
Hospitals  
Schools  
Corridors

#### DOMAINES D'UTILISATION

Centres Commerciaux  
Supermarchés  
Bureaux  
Salles de Réunions  
Magasins  
Hopitaux  
Ecoles  
Couloirs

#### BODY

Anodized aluminum with satin finishing. Black and white color options with elegant design.

#### DIFFUSER

UV stabilized frosted diffuser.

#### CONVERTER

Long life, low power loss converter with constant current. Compatible with ENEC standards.

#### LED

LED modules with 60.000 hours lifetime LUMILEDS / SAMSUNG / NICHIA brand LEDs.

#### SUSPENSION

Composed of 1mm steel wire rope and nickel-plated brass components. Suspension height is adjustable. Supplied with transparent electric cord and ceiling mounted electrical junction box with aesthetic design

#### CORPS

Corps en aluminium anodisé, satiné. Design élégant. Couleurs blanc, noir disponibles.

#### DIFFUSEUR

Diffuseur givré. Anti UV.

#### CONVERTEUR

Convertisseur, conforme aux normes ENEC. Longue vie. Perte de puissance faible avec courant constant.

#### LED

Modules LED – Durée de vie 60.000 heures avec LED de marque LUMILEDS / SAMSUNG / NICHIA.

#### SYSTEME DE FIXATION

Composé d'un fil en acier de 1mm, de composants en laiton nickelés. Livré avec un cordon électrique transparent et une boîte de jonction électrique à fixer au plafond. Hauteur de fixation réglable.

NOTE	NOTE
Given lumen values are net delivered luminaire output lumens.	Les valeurs de lumens données sont les lumens de sortie nets du luminaire.
Given power values are total consumed AC power of the luminaire.	Les valeurs de puissance données sont la puissance AC totale consommée du luminaire.

V / Hz	220 - 240 / 50 - 60
Options	Options
Dimmable electronic ballast or convertor.	Ballast électronique dimmable ou convertor.
Emergency kit	Kit d'urgence.

Color Options  
Options de Couleur



LED Type / Type LED

Color Rendering Index / Indice de Rendu des Couleurs: (CRI): Ra>80

Kod Code	Power Puissance (W)	LED Type Type De LED	LED Module Module LED	Lum. Flux Flux Lum. (lm)	Color Temperature Température De Couleur (K)	Dimensions (mm)			Weight Poids (kg)	Packing Quantity Colisage	Pcs./20" Container Pcs./20" Conteneur
						a	d	h			
PL8S04L15C	26	2835 SMD	PCB	2585	2700 - 6500	79	447	73	5,1	1	910
PL8S06L15C	39	2835 SMD	PCB	3880	2700 - 6500	79	620	73	6,0	1	550
PL8S06L25C	61	2835 SMD	PCB	5835	2700 - 6500	79	620	73	6,0	1	550
PL8S08L15C	53	2835 SMD	PCB	5170	2700 - 6500	79	800	73	7,7	1	340
PL8S08L25C	80	2835 SMD	PCB	7780	2700 - 6500	79	800	73	7,7	1	340
PL8S010L15C	66	2835 SMD	PCB	6460	2700 - 6500	79	980	73	10,7	1	230
PL8S010L25C	100	2835 SMD	PCB	9725	2700 - 6500	79	980	73	10,7	1	230
PL8S012L15C	79	2835 SMD	PCB	7755	2700 - 6500	79	1155	73	12,7	1	165
PL8S012L25C	120	2835 SMD	PCB	11670	2700 - 6500	79	1155	73	12,7	1	165
PL8S014L15C	92	2835 SMD	PCB	9045	2700 - 6500	79	1335	73	14,7	1	125
PL8S014L25C	140	2835 SMD	PCB	13615	2700 - 6500	79	1335	73	14,7	1	125
PL8S016L15C	105	2835 SMD	PCB	10340	2700 - 6500	79	1500	73	17,7	1	100
PL8S016L25C	160	2835 SMD	PCB	15560	2700 - 6500	79	1500	73	17,7	1	100
PL8S020L15C	132	2835 SMD	PCB	13300	2700 - 6500	79	1890	73	18,7	1	63
PL8S020L25C	200	2835 SMD	PCB	20020	2700 - 6500	79	1890	73	18,7	1	63
PL8S022L15C	145	2835 SMD	PCB	14630	2700 - 6500	79	2070	73	19,2	1	55
PL8S022L25C	221	2835 SMD	PCB	22025	2700 - 6500	79	2070	73	19,2	1	55
PL8S024L15C	158	2835 SMD	PCB	15960	2700 - 6500	79	2254	73	19,7	1	62
PL8S024L25C	240	2835 SMD	PCB	24025	2700 - 6500	79	2254	73	19,7	1	62

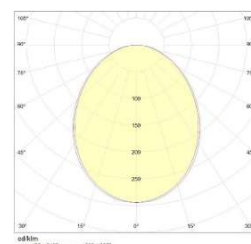
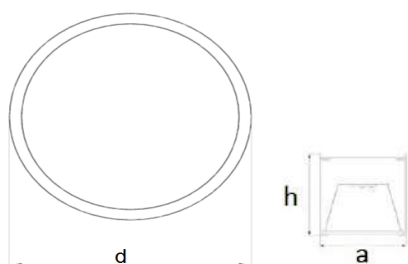



# GALAKSI O VISION

## LED

### Suspended Lighting Fixtures With Special Lens

### Luminaires Suspendus Avec Lentille Spéciale

#### APPLICATION AREAS

Shopping Malls  
Supermarkets  
Offices  
Meeting rooms  
Stores  
Hospitals  
Schools  
Corridors

#### DOMAINES D'UTILISATION

Centres Commerciaux  
Supermarchés  
Bureaux  
Salles de Réunions  
Magasins  
Hopitaux  
Ecoles  
Couloirs

#### BODY

Anodized aluminum with satin finishing. Black and white color options with elegant design.

#### LENS

Special lens for focused light distribution.

#### CONVERTER

Long life, low power loss converter with constant current. Compatible with ENEC standards.

#### LED

LED modules with 60.000 hours lifetime LUMILEDS / SAMSUNG / NICHIA brand LEDs.

#### SUSPENSION

Composed of 1mm steel wire rope and nickel-plated brass components. Suspension height is adjustable. Supplied with transparent electric cord and ceiling mounted electrical junction box with aesthetic design

#### CORPS

Corps en aluminium anodisé, satiné. Design élégant. Couleurs blanc, noir disponibles.

#### LENTILLE

Lentille spéciale pour une distribution lumineuse focalisée.

#### CONVERTEUR

Convertisseur, conforme aux normes ENEC. Longue vie. Perte de puissance faible avec courant constant.

#### LED

Modules LED – Durée de vie 60.000 heures avec LED de marque LUMILEDS / SAMSUNG / NICHIA.

#### SYSTEME DE FIXATION

Composé d'un fil en acier de 1mm, de composants en laiton nickelés. Livré avec un cordon électrique transparent et une boîte de jonction électrique à fixer au plafond. Hauteur de fixation réglable.

NOTE	NOTE
Given lumen values are net delivered luminaire output lumens.	Les valeurs de lumens données sont les lumens de sortie nets du luminaire.
Given power values are total consumed AC power of the luminaire.	Les valeurs de puissance données sont la puissance AC totale consommée du luminaire.

V / Hz	220 - 240 / 50 - 60
Options	Options
Dimmable electronic ballast or convertor.	Ballast électronique dimmable ou convertor.
Emergency kit	Kit d'urgence.

Color Options  
Options de Couleur



LED Type / Type LED

Color Rendering Index / Indice de Rendu des Couleurs: (CRI): Ra>80

Kod Code	Power Puissance (W)	LED Type Type De LED	LED Module Module LED	Lum. Flux Flux Lum. (lm)	Color Temperature Température De Couleur (K)	Dimensions (mm)			Weight Poids (kg)	Packing Quantity Colisage	Pcs./20" Container Pcs./20" Conteneur	Lens Quantity Quantité de Lentilles
						a	d	h				
PL8SOV4L15C	12	2835 SMD	PCB	1040	2700 - 6500	79	447	73	5,1	1	910	8
PL8SOV4L25C	18	2835 SMD	PCB	1560	2700 - 6500	79	447	73	5,1	1	910	12
PL8SOV6L15C	18	2835 SMD	PCB	1560	2700 - 6500	79	620	73	6,0	1	550	12
PL8SOV6L25C	27	2835 SMD	PCB	2340	2700 - 6500	79	620	73	6,0	1	550	18
PL8SOV8L15C	24	2835 SMD	PCB	2080	2700 - 6500	79	800	73	7,7	1	340	16
PL8SOV8L25C	36	2835 SMD	PCB	3120	2700 - 6500	79	800	73	7,7	1	340	24
PL8SOV10L15C	30	2835 SMD	PCB	2600	2700 - 6500	79	980	73	10,7	1	230	20
PL8SOV10L25C	45	2835 SMD	PCB	3900	2700 - 6500	79	980	73	10,7	1	230	30
PL8SOV12L15C	36	2835 SMD	PCB	3120	2700 - 6500	79	1155	73	12,7	1	165	24
PL8SOV12L25C	54	2835 SMD	PCB	4680	2700 - 6500	79	1155	73	12,7	1	165	36
PL8SOV14L15C	42	2835 SMD	PCB	3640	2700 - 6500	79	1335	73	14,7	1	125	28
PL8SOV14L25C	63	2835 SMD	PCB	5460	2700 - 6500	79	1335	73	14,7	1	125	42
PL8SOV16L15C	48	2835 SMD	PCB	4160	2700 - 6500	79	1500	73	17,7	1	100	32
PL8SOV16L25C	72	2835 SMD	PCB	6240	2700 - 6500	79	1500	73	17,7	1	100	48
PL8SOV20L15C	60	2835 SMD	PCB	5200	2700 - 6500	79	1890	73	18,7	1	63	40
PL8SOV20L25C	90	2835 SMD	PCB	7800	2700 - 6500	79	1890	73	18,7	1	63	60
PL8SOV22L15C	66	2835 SMD	PCB	5720	2700 - 6500	79	2070	73	19,2	1	55	44
PL8SOV22L25C	99	2835 SMD	PCB	8580	2700 - 6500	79	2070	73	19,2	1	55	66
PL8SOV24L15C	72	2835 SMD	PCB	6240	2700 - 6500	79	2254	73	19,7	1	62	48
PL8SOV24L25C	108	2835 SMD	PCB	9360	2700 - 6500	79	2254	73	19,7	1	62	72

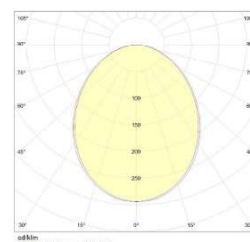
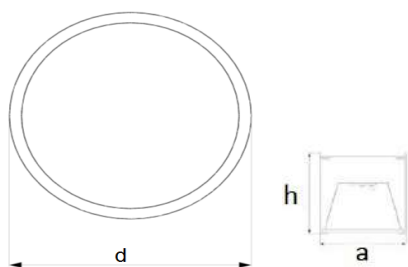



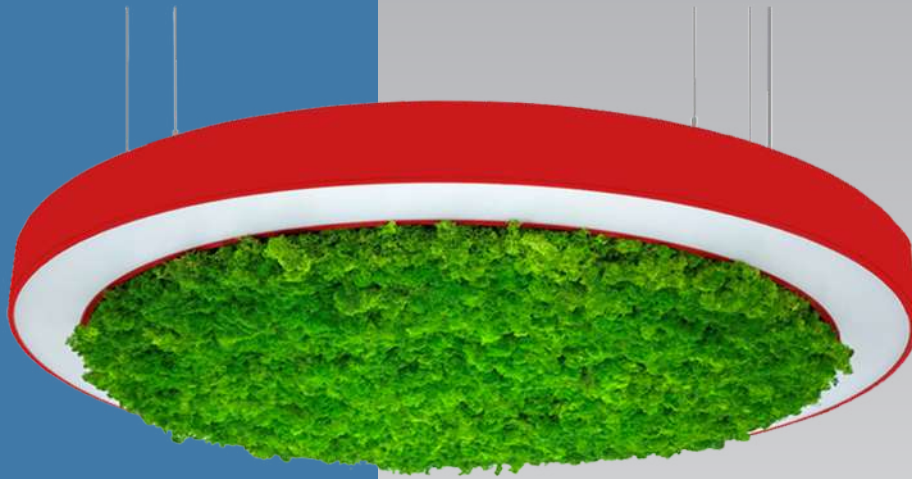

## GALAKSI O ACOUSTIC

### LED

Suspended Lighting Fixtures With Frosted Diffuser & Special Moss

Luminaire Suspendus Avec Diffuseur Givré et Mousse Spéciale

#### BODY

Anodized aluminum with satin finishing. Black and white color options with elegant design.

#### MOSS

Natural moss that absorbs excess noise in the environment.

#### DIFFUSER

UV stabilized frosted diffuser.

#### CONVERTER

Long life, low power loss converter with constant current. Compatible with ENEC standards.

#### LED

LED modules with 60.000 hours lifetime LUMILEDS / SAMSUNG / NICHIA brand LEDs.

#### SUSPENSION

Composed of 1mm steel wire rope and nickel-plated brass components. Suspension height is adjustable. Supplied with transparent electric cord and ceiling mounted electrical junction box with aesthetic design

#### APPLICATION AREAS

Shopping Malls  
Supermarkets  
Offices  
Meeting rooms  
Stores  
Hospitals  
Schools

#### DOMAINES D'UTILISATION

Centres Commerciaux  
Supermarchés  
Bureaux  
Salles de Réunions  
Magasins  
Hopitaux  
Ecoles

#### CORPS

Corps en aluminium anodisé, satiné. Design élégant. Couleurs blanc, noir disponibles.

#### MOUSSE

Mousse naturelle qui absorbe l'excès de bruit dans l'environnement.

#### DIFFUSEUR

Diffuseur givré. Anti UV.

#### CONVERTEUR

Convertisseur, conforme aux normes ENEC. Longue vie. Perte de puissance faible avec courant constant.

#### LED

Modules LED – Durée de vie 60.000 heures avec LED de marque LUMILEDS / SAMSUNG / NICHIA.

#### SYSTEME DE FIXATION

Composé d'un fil en acier de 1mm, de composants en laiton nickelés. Livré avec un cordon électrique transparent et une boîte de jonction électrique à fixer au plafond. Hauteur de fixation réglable.

Color Options  
Options de Couleur



LED Type / Type LED

Color Rendering Index / Indice de Rendu des Couleurs: (CRI): Ra>80

Kod Code	Power Puissance (W)	LED Type Type De LED	LED Module Module LED	Lum. Flux Flux Lum. (lm)	Color Temperature Température De Couleur (K)	Dimensions (mm)			Weight Poids (kg)	Packing Quantity Colisage	Pcs./20" Container Pcs./20" Conteneur
						a	d	h			
PL8SA04L15C	26	2835 SMD	PCB	2585	2700 - 6500	79	447	73	5,1	1	910
PL8SA06L15C	39	2835 SMD	PCB	3880	2700 - 6500	79	620	73	6,0	1	550
PL8SA06L25C	61	2835 SMD	PCB	5835	2700 - 6500	79	620	73	6,0	1	550
PL8SA08L15C	53	2835 SMD	PCB	5170	2700 - 6500	79	800	73	7,7	1	340
PL8SA08L25C	80	2835 SMD	PCB	7780	2700 - 6500	79	800	73	7,7	1	340
PL8SA010L15C	66	2835 SMD	PCB	6460	2700 - 6500	79	980	73	10,7	1	230
PL8SA010L25C	100	2835 SMD	PCB	9725	2700 - 6500	79	980	73	10,7	1	230
PL8SA012L15C	79	2835 SMD	PCB	7755	2700 - 6500	79	1155	73	12,7	1	165
PL8SA012L25C	120	2835 SMD	PCB	11670	2700 - 6500	79	1155	73	12,7	1	165
PL8SA014L15C	92	2835 SMD	PCB	9045	2700 - 6500	79	1335	73	14,7	1	125
PL8SA014L25C	140	2835 SMD	PCB	13615	2700 - 6500	79	1335	73	14,7	1	125
PL8SA016L15C	105	2835 SMD	PCB	10340	2700 - 6500	79	1500	73	17,7	1	100
PL8SA016L25C	160	2835 SMD	PCB	15560	2700 - 6500	79	1500	73	17,7	1	100
PL8SA020L15C	132	2835 SMD	PCB	13300	2700 - 6500	79	1890	73	18,7	1	63
PL8SA020L25C	200	2835 SMD	PCB	20020	2700 - 6500	79	1890	73	19,1	1	63
PL8SA022L15C	145	2835 SMD	PCB	14630	2700 - 6500	79	2070	73	19,2	1	55
PL8SA022L25C	221	2835 SMD	PCB	22025	2700 - 6500	79	2070	73	19,2	1	55

V / Hz 220 - 240 / 50 - 60

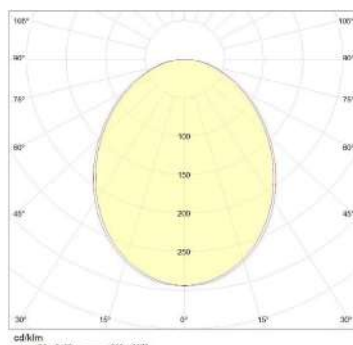
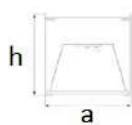
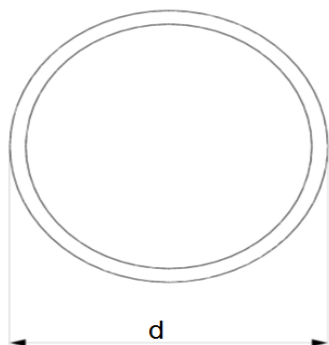

Options

Dimmable electronic ballast or convertor.  
Emergency kit

Options

Ballast électronique dimmable ou convertor.  
Kit d'urgence.

NOTE

Given lumen values are net delivered luminaire output lumens.

Given power values are total consumed AC power of the luminaire.

NOTE

Les valeurs de lumens données sont les lumens de sortie nets du luminaire.

Les valeurs de puissance données sont la puissance AC totale consommée du luminaire.



# GALAKSI S VISION

## LED

### Suspended Lighting Fixtures With Special Lens

### Luminaire suspendus Avec Lentille Spéciale

#### APPLICATION AREAS

Shopping Malls  
Supermarkets  
Offices  
Meeting rooms  
Stores  
Hospitals  
Schools  
Corridors

#### DOMAINES D'UTILISATION

Centres Commerciaux  
Supermarchés  
Bureaux  
Salles de Réunions  
Magasins  
Hopitaux  
Ecoles  
Couloirs

#### BODY

Anodized aluminum with satin finishing. Black and white color options with elegant design.

#### LENS

Special lens for focused light distribution.

#### CONVERTER

Long life, low power loss converter with constant current. Compatible with ENEC standards.

#### LED

LED modules with 60.000 hours lifetime LUMILEDS / SAMSUNG / NICHIA brand LEDs.

#### SUSPENSION

Composed of 1mm steel wire rope and nickel-plated brass components. Suspension height is adjustable. Supplied with transparent electric cord and ceiling mounted electrical junction box with aesthetic design

#### CORPS

Corps en aluminium anodisé, satiné. Design élégant. Couleurs blanc, noir disponibles.

#### LENTILLE

Lentille spéciale pour une distribution lumineuse focalisée.

#### CONVERTEUR

Convertisseur, conforme aux normes ENEC. Longue vie. Perte de puissance faible avec courant constant.

#### LED

Modules LED – Durée de vie 60.000 heures avec LED de marque LUMILEDS / SAMSUNG / NICHIA.

#### SYSTEME DE FIXATION

Composé d'un fil en acier de 1mm, de composants en laiton nickelés. Livré avec un cordon électrique transparent et une boîte de jonction électrique à fixer au plafond. Hauteur de fixation réglable.

Color Options  
Options de Couleur



LED Type / Type LED

Color Rendering Index / Indice de Rendu des Couleurs: (CRI): Ra>80

Code	Power Puissance (W)	LED Type Type De LED	LED Module Module LED	Lum. Flux Flux Lum. (lm)	Color Temperature Température De Couleur (K)	Dimensions (mm)				Weight Poids (kg)	Packing Quantity Colisage	Pcs./20" Container Pcs./20" Conteneur	Drawing No Dessin No	Lens Quantity Quantité de Lentilles
						l	k	a	h					
PL8SSV23L15C	18	2835 SMD	PCB	1560	2700 - 6500	1570	334	79	82	3,9	1	445	1	12
PL8SSV23L25C	27	2835 SMD	PCB	2340	2700 - 6500	1570	334	79	82	3,9	1	445		18
PL8SSV33L15C	27	2835 SMD	PCB	2340	2700 - 6500	2360	395	79	82	5,7	1	233	2	18
PL8SSV33L25C	40	2835 SMD	PCB	3510	2700 - 6500	2360	395	79	82	5,9	1	233		27
PL8SSV24L15C	24	2835 SMD	PCB	2080	2700 - 6500	2070	495	79	82	5,1	1	284	1	16
PL8SSV24L25C	36	2835 SMD	PCB	3120	2700 - 6500	2070	495	79	82	5,3	1	284		24
PL8SSV34L15C	36	2835 SMD	PCB	3120	2700 - 6500	3095	495	79	82	7,7	1	142	2	24
PL8SSV34L25C	54	2835 SMD	PCB	4680	2700 - 6500	3095	495	79	82	7,9	1	142		36
PL8SSV25L15C	30	2835 SMD	PCB	2600	2700 - 6500	2620	610	79	82	6,3	1	137	1	20
PL8SSV25L25C	45	2835 SMD	PCB	3900	2700 - 6500	2620	610	79	82	6,5	1	137		30

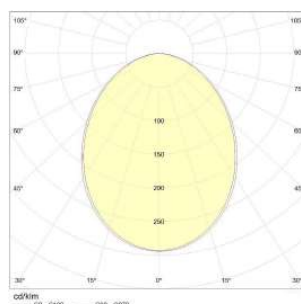
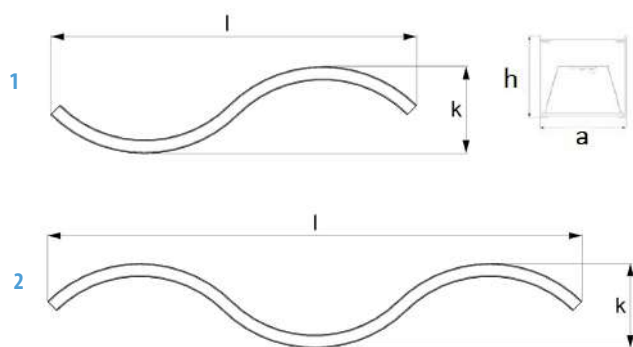

V / Hz 220 - 240 / 50 - 60

Options	Options
Dimmable electronic ballast or convertor. Emergency kit	Ballast électronique dimmable ou converteur. Kit d'urgence.
NOTE	NOTE
Given lumen values are net delivered luminaire output lumens.	Les valeurs de lumens données sont les lumens de sortie nets du luminaire.
Given power values are total consumed AC power of the luminaire.	Les valeurs de puissance données sont la puissance AC totale consommée du luminaire.

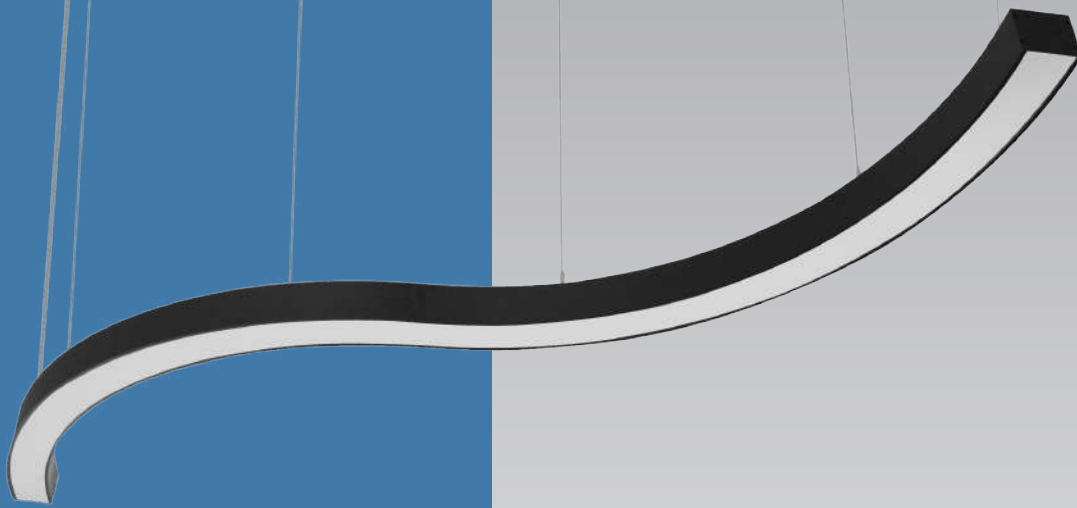

# GALAKSI S

## LED

### Suspended Lighting Fixtures With Frosted Diffuser

### Luminaire Suspendus Avec Diffuseur Givré

#### APPLICATION AREAS

Shopping Malls  
Supermarkets  
Offices  
Meeting rooms  
Stores  
Hospitals  
Schools  
Corridors

#### DOMAINES D'UTILISATION

Centres Commerciaux  
Supermarchés  
Bureaux  
Salles de Réunions  
Magasins  
Hopitaux  
Ecoles  
Couloirs

#### BODY

Anodized aluminum with satin finishing. Black and white color options with elegant design.

#### DIFFUSER

UV stabilized frosted diffuser.

#### CONVERTER

Long life, low power loss converter with constant current. Compatible with ENEC standards.

#### LED

LED modules with 60.000 hours lifetime LUMILEDS / SAMSUNG / NICHIA brand LEDs.

#### SUSPENSION

Composed of 1mm steel wire rope and nickel-plated brass components. Suspension height is adjustable. Supplied with transparent electric cord and ceiling mounted electrical junction box with aesthetic design

#### CORPS

Corps en aluminium anodisé, satiné. Design élégant. Couleurs blanc, noir disponibles.

#### DIFFUSEUR

Diffuseur givré. Anti UV.

#### CONVERTEUR

Convertisseur, conforme aux normes ENEC. Longue vie. Perte de puissance faible avec courant constant .

#### LED

Modules LED – Durée de vie 60.000 heures avec LED de marque LUMILEDS / SAMSUNG / NICHIA.

#### SYSTEME DE FIXATION

Composé d'un fil en acier de 1mm , de composants en laiton nickelés. Livré avec un cordon électrique transparent et une boîte de jonction électrique à fixer au plafond. Hauteur de fixation réglable.

Color Options  
Options de Couleur



LED Type / Type LED

Color Rendering Index / Indice de Rendu des Couleurs: (CRI): Ra>80

Code	Power Puissance (W)	LED Type Type De LED	LED Module Module LED	Lum. Flux Flux Lum. (lm)	Color Temperature Température De Couleur (K)	Dimensions (mm)				Weight Poids (kg)	Packing Quantity Colisage	Pcs./20" Container Pcs./20" Conteneur	Drawing No Dessin No
						l	k	a	h				
PL8SS23L15C	39	2835 SMD	PCB	3880	2700 - 6500	1570	334	79	82	3,9	1	445	1
PL8SS23L25C	61	2835 SMD	PCB	5835	2700 - 6500	1570	334	79	82	3,9	1	445	
PL8SS33L15C	60	2835 SMD	PCB	5815	2700 - 6500	2360	395	79	82	5,7	1	233	2
PL8SS33L25C	90	2835 SMD	PCB	8755	2700 - 6500	2360	395	79	82	5,9	1	233	
PL8SS24L15C	53	2835 SMD	PCB	5170	2700 - 6500	2070	495	79	82	5,1	1	284	1
PL8SS24L25C	80	2835 SMD	PCB	7780	2700 - 6500	2070	495	79	82	5,3	1	284	
PL8SS34L15C	79	2835 SMD	PCB	7755	2700 - 6500	3095	495	79	82	7,7	1	142	2
PL8SS34L25C	120	2835 SMD	PCB	11670	2700 - 6500	3095	495	79	82	7,9	1	142	
PL8SS25L15C	66	2835 SMD	PCB	6460	2700 - 6500	2620	610	79	82	6,3	1	137	1
PL8SS25L25C	100	2835 SMD	PCB	9725	2700 - 6500	2620	610	79	82	6,5	1	137	

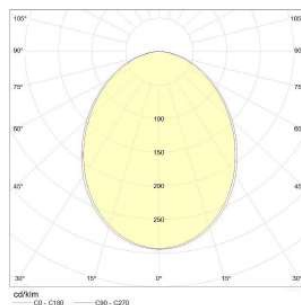
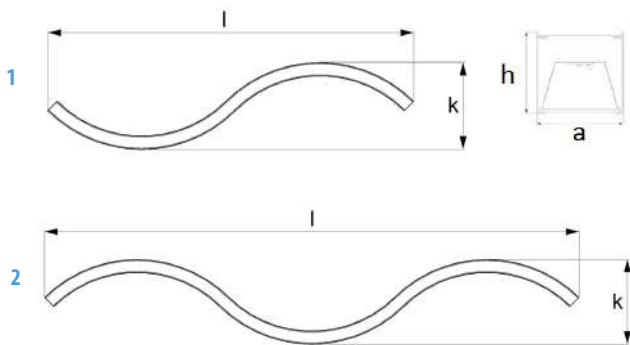

V / Hz 220 - 240 / 50 - 60

Options	Options
Dimmable electronic ballast or convertor. Emergency kit	Ballast électronique dimmable ou converteur. Kit d'urgence.
NOTE	NOTE
Given lumen values are net delivered luminaire output lumens.	Les valeurs de lumens données sont les lumens de sortie nets du luminaire.
Given power values are total consumed AC power of the luminaire.	Les valeurs de puissance données sont la puissance AC totale consommée du luminaire.

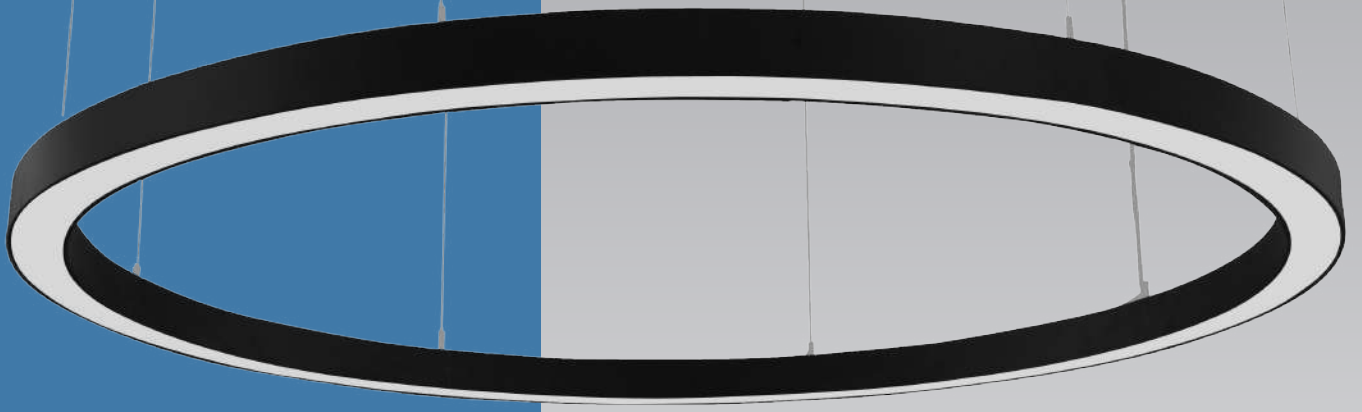

# GALAKSI ELIPS

## LED

### Suspended Lighting Fixtures With Frosted Diffuser

### Luminaire suspendus Avec Diffuseur Givré

#### APPLICATION AREAS

Shopping Malls  
Supermarkets  
Offices  
Meeting rooms  
Stores  
Hospitals  
Schools  
Corridors

#### DOMAINES D'UTILISATION

Centres Commerciaux  
Supermarchés  
Bureaux  
Salles de Réunions  
Magasins  
Hopitaux  
Ecoles  
Couloirs

#### BODY

Anodized aluminum with satin finishing. Black and white color options with elegant design.

#### DIFFUSER

UV stabilized frosted diffuser.

#### CONVERTER

Long life, low power loss converter with constant current. Compatible with ENEC standards.

#### LED

LED modules with 60.000 hours lifetime LUMILEDS / SAMSUNG / NICHIA brand LEDs.

#### SUSPENSION

Composed of 1mm steel wire rope and nickel-plated brass components. Suspension height is adjustable. Supplied with transparent electric cord and ceiling mounted electrical junction box with aesthetic design

#### CORPS

Corps en aluminium anodisé, satiné. Design élégant. Couleurs blanc, noir disponibles.

#### DIFFUSEUR

Diffuseur givré. Anti UV.

#### CONVERTEUR

Convertisseur, conforme aux normes ENEC. Longue vie. Perte de puissance faible avec courant constant .

#### LED

Modules LED – Durée de vie 60.000 heures avec LED de marque LUMILEDS / SAMSUNG / NICHIA.

#### SYSTEME DE FIXATION

Composé d'un fil en acier de 1mm , de composants en laiton nickelés. Livré avec un cordon électrique transparent et une boîte de jonction électrique à fixer au plafond. Hauteur de fixation réglable.

Color Options  
Options de Couleur



LED Type / Type LED

Color Rendering Index / Indice de Rendu des Couleurs: (CRI): Ra>80

Kod Code	Power Puissance (W)	LED Type Type De LED	LED Module Module LED	Lum. Flux Flux Lum. (lm)	Color Temperature Température De Couleur (K)	Dimensions (mm)			Weight Poids (kg)	Packing Quantity Colisage	Pcs./20" Container Pcs./20" Conteneur
						b	l	h			
PL8SE12L15C	79	2835 SMD	PCB	7755	2700 - 6500	576	1620	73	3,9	1	236
PL8SE12L25C	120	2835 SMD	PCB	11670	2700 - 6500	576	1620	73	5,1	1	236
PL8SE16L15C	105	2835 SMD	PCB	10340	2700 - 6500	956	2006	73	6,5	1	117
PL8SE16L25C	160	2835 SMD	PCB	15560	2700 - 6500	956	2006	73	7,7	1	117

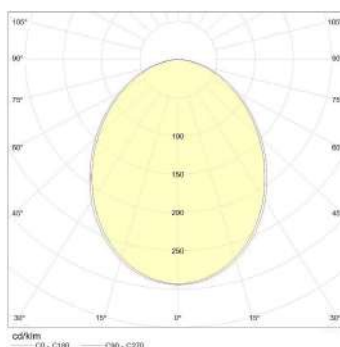
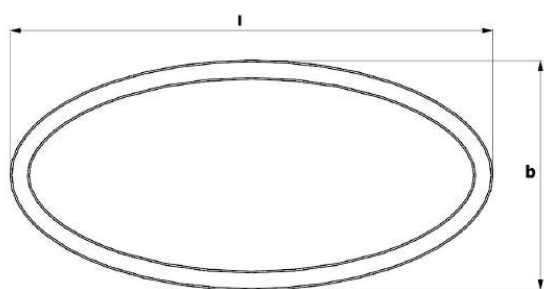

V / Hz 220 - 240 / 50 - 60

Options	Options
Dimmable electronic ballast or convertor.	Ballast électronique dimmable ou converteur.
Emergency kit	Kit d'urgence.

NOTE	NOTE
Given lumen values are net delivered luminaire output lumens.	Les valeurs de lumens données sont les lumens de sortie nets du luminaire.
Given power values are total consumed AC power of the luminaire.	Les valeurs de puissance données sont la puissance AC totale consommée du luminaire.

h





# GALAKSI HEXAGON

## LED

### Suspended Lighting Fixtures With Frosted Diffuser

### Luminaire Suspendus Avec Diffuseur Givré

#### APPLICATION AREAS

Shopping Malls  
Supermarkets  
Offices  
Meeting rooms  
Stores  
Hospitals  
Schools  
Corridors

#### DOMAINES D'UTILISATION

Centres Commerciaux  
Supermarchés  
Bureaux  
Salles de Réunions  
Magasins  
Hopitaux  
Ecoles  
Couloirs

#### BODY

Anodized aluminum with satin finishing. Black and white color options with elegant design.

#### DIFFUSER

UV stabilized frosted diffuser.

#### CONVERTER

Long life, low power loss converter with constant current. Compatible with ENEC standards.

#### LED

LED modules with 60.000 hours lifetime LUMILEDS / SAMSUNG / NICHIA brand LEDs.

#### SUSPENSION

Composed of 1mm steel wire rope and nickel-plated brass components. Suspension height is adjustable. Supplied with transparent electric cord and ceiling mounted electrical junction box with aesthetic design

#### CORPS

Corps en aluminium anodisé, satiné. Design élégant. Couleurs blanc, noir disponibles.

#### DIFFUSEUR

Diffuseur givré. Anti UV.

#### CONVERTEUR

Convertisseur, conforme aux normes ENEC. Longue vie. Perte de puissance faible avec courant constant .

#### LED

Modules LED – Durée de vie 60.000 heures avec LED de marque LUMILEDS / SAMSUNG / NICHIA.

#### SYSTEME DE FIXATION

Composé d'un fil en acier de 1mm , de composants en laiton nickelés. Livré avec un cordon électrique transparent et une boîte de jonction électrique à fixer au plafond. Hauteur de fixation réglable.

Color Options  
Options de Couleur



LED Type / Type LED

Color Rendering Index / Indice de Rendu des Couleurs: (CRI): Ra>80

Code	Power Puissance (W)	LED Type Type De LED	LED Module Module LED	Lum. Flux Flux Lum. (lm)	Color Temperature Température De Couleur (K)	Dimensions (mm)				Weight Poids (kg)	Packing Quantity Colisage	Pcs./20" Container Pcs./20" Conteneur
						a	b	c	h			
PL8SA51E15C	51	2835 SMD	PCB	4800	2700 - 6500	680	589	340	97	7.1	1	450
PL8SA73E15C	73	2835 SMD	PCB	7050	2700 - 6500	800	693	400	97	7.8	1	430

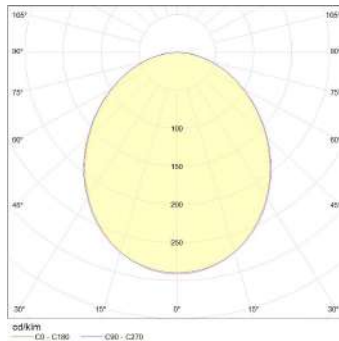
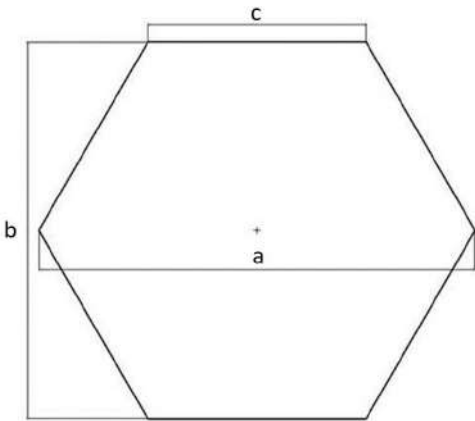

V / Hz 220 - 240 / 50 - 60

<b>Options</b> Dimmable electronic ballast or convertor. Emergency kit	<b>Options</b> Ballast électronique dimmable ou converteur. Kit d'urgence.
<b>NOTE</b> Given lumen values are net delivered luminaire output lumens.	<b>NOTE</b> Les valeurs de lumens données sont les lumens de sortie nets du luminaire.
<b>NOTE</b> Given power values are total consumed AC power of the luminaire.	<b>NOTE</b> Les valeurs de puissance données sont la puissance AC totale consommée du luminaire.



# GALAKSI DOLUNAY DIRECT / INDIRECT

## LED

Suspended Lighting Fixtures With Frosted Diffuser

Luminaire suspendus Avec Diffuseur Givré

### APPLICATION AREAS

Shopping Malls  
Supermarkets  
Offices  
Meeting rooms  
Stores  
Hospitals  
Schools  
Corridors

### DOMAINES D'UTILISATION

Centres Commerciaux  
Supermarchés  
Bureaux  
Salles de Réunions  
Magasins  
Hopitaux  
Ecoles  
Couloirs

#### BODY

Anodized aluminum with satin finishing. Black and white color options with elegant design.

#### DIFFUSER

UV stabilized frosted diffuser.

#### CONVERTER

Long life, low power loss converter with constant current. Compatible with ENEC standards.

#### LED

LED modules with 60.000 hours lifetime LUMILEDS / SAMSUNG / NICHIA brand LEDs.

#### SUSPENSION

Composed of 1mm steel wire rope and nickel-plated brass components. Suspension height is adjustable. Supplied with transparent electric cord and ceiling mounted electrical junction box with aesthetic design

#### CORPS

Corps en aluminium anodisé, satiné. Design élégant. Couleurs blanc, noir disponibles.

#### DIFFUSEUR

Diffuseur givré. Anti UV.

#### CONVERTEUR

Convertisseur, conforme aux normes ENEC. Longue vie. Perte de puissance faible avec courant constant.

#### LED

Modules LED – Durée de vie 60.000 heures avec LED de marque LUMILEDS / SAMSUNG / NICHIA.

#### SYSTEME DE FIXATION

Composé d'un fil en acier de 1mm, de composants en laiton nickelés. Livré avec un cordon électrique transparent et une boîte de jonction électrique à fixer au plafond. Hauteur de fixation réglable.

Indirect Lighting  
Éclairage Indirect

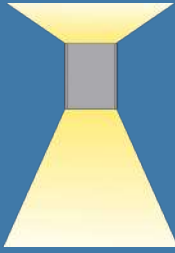

Direct Lighting  
Éclairage Direct

Color Options  
Options de Couleur



LED Type / Type LED

Color Rendering Index / Indice de Rendu des Couleurs: (CRI): Ra>80

Code	Power Puissance (W)	LED Type Type De LED	LED Module Module LED	Lum. Flux Flux Lum. (lm)	Color Temperature Température De Couleur (K)	Dimensions (mm) d h	Weight Poids (kg)	Packing Quantity Colisage	Pcs./20" Container Pcs./20" Conteneur
PL8ESD17E15C	18 / 11	2835 SMD	PCB	1725 / 845	2700 - 6500	360 97	3.5	1	1176
PL8ESD25E15C	27 / 14	2835 SMD	PCB	2585 / 1125	2700 - 6500	470 97	5.6	1	730
PL8ESD38E15C	40 / 18	2835 SMD	PCB	3880 / 1405	2700 - 6500	600 97	7.1	1	470
PL8ESD80E15C	83 / 28	2835 SMD	PCB	8185 / 2250	2700 - 6500	900 97	7.6	1	220
PL8ESD143E15C	147 / 35	2835 SMD	PCB	14645 / 2810	2700 - 6500	1200 97	9.7	1	125



In-Direct Side LED Type / Type de LED Côté Indirecte

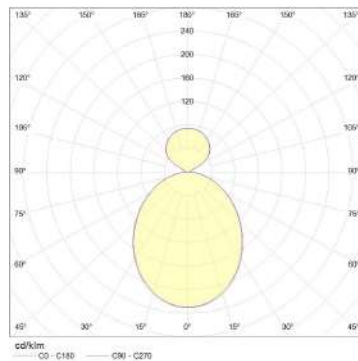
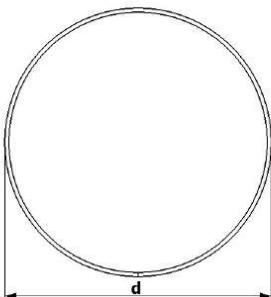

V / Hz 220 - 240 / 50 - 60

Options	Options
Dimmable electronic ballast or convertor. Emergency kit	Ballast électronique dimmable ou converteur. Kit d'urgence.
<b>NOTE</b> Given lumen values are net delivered luminaire output lumens.	<b>NOTE</b> Les valeurs de lumens données sont les lumens de sortie nets du luminaire.
Given power values are total consumed AC power of the luminaire.	Les valeurs de puissance données sont la puissance AC totale consommée du luminaire.



# GALAKSI DOLUNAY

## LED

### Suspended Lighting Fixtures With Frosted Diffuser

### Luminaire Suspendus Avec Diffuseur Givré

#### APPLICATION AREAS

Shopping Malls  
Supermarkets  
Offices  
Meeting rooms  
Stores  
Hospitals  
Schools  
Corridors

#### DOMAINES D'UTILISATION

Centres Commerciaux  
Supermarchés  
Bureaux  
Salles de Réunions  
Magasins  
Hopitaux  
Ecoles  
Couloirs

#### BODY

Anodized aluminum with satin finishing. Black and white color options with elegant design.

#### DIFFUSER

UV stabilized frosted diffuser.

#### CONVERTER

Long life, low power loss converter with constant current. Compatible with ENEC standards.

#### LED

LED modules with 60.000 hours lifetime LUMILEDS / SAMSUNG / NICHIA brand LEDs.

#### SUSPENSION

Composed of 1mm steel wire rope and nickel-plated brass components. Suspension height is adjustable. Supplied with transparent electric cord and ceiling mounted electrical junction box with aesthetic design

#### CORPS

Corps en aluminium anodisé, satiné. Design élégant. Couleurs blanc, noir disponibles.

#### DIFFUSEUR

Diffuseur givré. Anti UV.

#### CONVERTEUR

Convertisseur, conforme aux normes ENEC. Longue vie. Perte de puissance faible avec courant constant .

#### LED

Modules LED – Durée de vie 60.000 heures avec LED de marque LUMILEDS / SAMSUNG / NICHIA.

#### SYSTEME DE FIXATION

Composé d'un fil en acier de 1mm , de composants en laiton nickelés. Livré avec un cordon électrique transparent et une boîte de jonction électrique à fixer au plafond. Hauteur de fixation réglable.

Color Options  
Options de Couleur



LED Type / Type LED

Color Rendering Index / Indice de Rendu des Couleurs: (CRI): Ra>80

Code	Power Puissance (W)	LED Type Type De LED	LED Module Module LED	Lum. Flux Flux Lum. (lm)	Color Temperature Température De Couleur (K)	Dimensions (mm) d h	Weight Poids (kg)	Packing Quantity Colisage	Pcs./20" Container Pcs./20" Conteneur
PL8SD17E15C	18	2835 SMD	PCB	1725	2700 - 6500	360 97	3.1	1	1176
PL8SD25E15C	27	2835 SMD	PCB	2585	2700 - 6500	470 97	5.2	1	730
PL8SD38E15C	40	2835 SMD	PCB	3880	2700 - 6500	600 97	6.5	1	470
PL8SD80E15C	83	2835 SMD	PCB	8185	2700 - 6500	900 97	7.2	1	220
PL8SD143E15C	147	2835 SMD	PCB	14645	2700 - 6500	1200 97	9.3	1	125

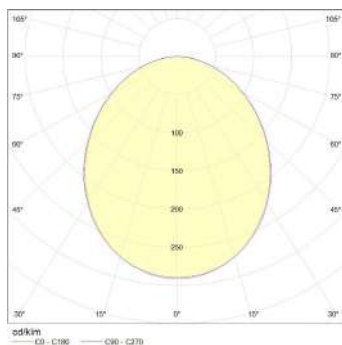
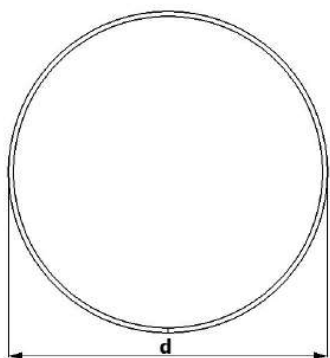

V / Hz 220 - 240 / 50 - 60

Options	Options
Dimmable electronic ballast or convertor. Emergency kit	Ballast électronique dimmable ou converteur. Kit d'urgence.
NOTE	NOTE
Given lumen values are net delivered luminaire output lumens.	Les valeurs de lumens données sont les lumens de sortie nets du luminaire.
Given power values are total consumed AC power of the luminaire.	Les valeurs de puissance données sont la puissance AC totale consommée du luminaire.



# GALAKSI DOLUNAY

## LED

Surface Mounted Lighting Fixtures With Frosted Diffuser

Luminaires Apparents Avec Diffuseur Givré

### APPLICATION AREAS

Shopping Malls  
Supermarkets  
Offices  
Meeting rooms  
Stores  
Hospitals  
Schools

### DOMAINES D'UTILISATION

Centres Commerciaux  
Supermarchés  
Bureaux  
Salles de Réunions  
Magasins  
Hopitaux  
Ecoles

#### BODY

Anodized aluminum with satin finishing. Black and white color options with elegant design.

#### DIFFUSER

UV stabilized frosted diffuser.

#### CONVERTER

Long life, low power loss converter with constant current. Compatible with ENEC standards.

#### LED

LED modules with 60.000 hours lifetime LUMILEDS / SAMSUNG / NICHIA brand LEDs.

#### CORPS

Corps en aluminium anodisé, satiné. Design élégant. Couleurs blanc, noir disponibles.

#### DIFFUSEUR

Diffuseur givré. Anti UV.

#### CONVERTEUR

Convertisseur, conforme aux normes ENEC. Longue vie. Perte de puissance faible avec courant constant .

#### LED

Modules LED – Durée de vie 60.000 heures avec LED de marque LUMILEDS / SAMSUNG / NICHIA.

Color Options  
Options de Couleur



LED Type / Type LED

Color Rendering Index / Indice de Rendu des Couleurs: (CRI): Ra>80

Code	Power Puissance (W)	LED Type Type De LED	LED Module Module LED	Lum. Flux Flux Lum. (lm)	Color Temperature Température De Couleur (K)	Dimensions (mm) d h		Weight Poids (kg)	Packing Quantity Colisage	Pcs./20" Container Pcs./20" Conteneur
PL8UD17E15C	18	2835 SMD	PCB	1725	2700 - 6500	360	97	2.9	1	1176
PL8UD25E15C	27	2835 SMD	PCB	2585	2700 - 6500	470	97	5.0	1	730
PL8UD38E15C	40	2835 SMD	PCB	3880	2700 - 6500	600	97	6.3	1	470
PL8UD80E15C	83	2835 SMD	PCB	8185	2700 - 6500	900	97	7.0	1	220
PL8UD143E15C	147	2835 SMD	PCB	14645	2700 - 6500	1200	97	9.1	1	125

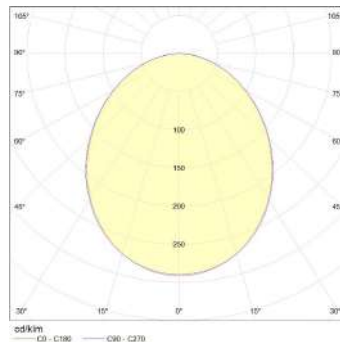
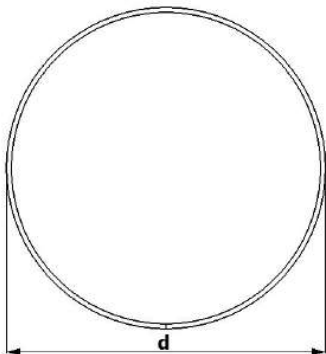

V / Hz 220 - 240 / 50 - 60

Options	Options
Dimmable electronic ballast or convertor. Emergency kit	Ballast électronique dimmable ou converteur. Kit d'urgence.
NOTE	NOTE
Given lumen values are net delivered luminaire output lumens.	Les valeurs de lumens données sont les lumens de sortie nets du luminaire.
Given power values are total consumed AC power of the luminaire.	Les valeurs de puissance données sont la puissance AC totale consommée du luminaire.



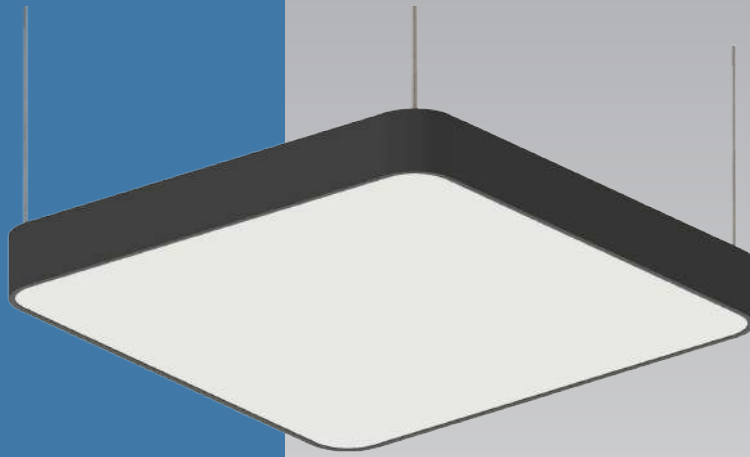

# GALAKSI SQUARE

## LED

### Suspended Lighting Fixtures With Frosted Diffuser

### Luminaire suspendus Avec Diffuseur Givré

#### APPLICATION AREAS

Shopping Malls  
Supermarkets  
Offices  
Meeting rooms  
Stores  
Hospitals  
Schools  
Corridors

#### DOMAINES D'UTILISATION

Centres Commerciaux  
Supermarchés  
Bureaux  
Salles de Réunions  
Magasins  
Hopitaux  
Ecoles  
Couloirs

#### BODY

Anodized aluminum with satin finishing. Black and white color options with elegant design.

#### DIFFUSER

UV stabilized frosted diffuser.

#### CONVERTER

Long life, low power loss converter with constant current. Compatible with ENEC standards.

#### LED

LED modules with 60.000 hours lifetime LUMILEDS / SAMSUNG / NICHIA brand LEDs.

#### SUSPENSION

Composed of 1mm steel wire rope and nickel-plated brass components. Suspension height is adjustable. Supplied with transparent electric cord and ceiling mounted electrical junction box with aesthetic design

#### CORPS

Corps en aluminium anodisé, satiné. Design élégant. Couleurs blanc, noir disponibles.

#### DIFFUSEUR

Diffuseur givré. Anti UV.

#### CONVERTEUR

Convertisseur, conforme aux normes ENEC. Longue vie. Perte de puissance faible avec courant constant.

#### LED

Modules LED – Durée de vie 60.000 heures avec LED de marque LUMILEDS / SAMSUNG / NICHIA.

#### SYSTEME DE FIXATION

Composé d'un fil en acier de 1mm, de composants en laiton nickelés. Livré avec un cordon électrique transparent et une boîte de jonction électrique à fixer au plafond. Hauteur de fixation réglable.

Color Options  
Options de Couleur



LED Type / Type LED

Color Rendering Index / Indice de Rendu des Couleurs: (CRI): Ra>80

Code	Power Puissance (W)	LED Type Type De LED	LED Module Module LED	Lum. Flux Flux Lum. (lm)	Color Temperature Température De Couleur (K)	Dimensions (mm)			Weight Poids (kg)	Packing Quantity Colisage	Pcs./20" Container Pcs./20" Conteneur
						d1	d2	h			
PL8SDK11E05C	11	2835 SMD	PCB	1360	2700 - 6500	300	300	97	3.5	1	1614
PL8SDK12E04C	21	2835 SMD	PCB	2000	2700 - 6500	300	600	97	4.5	1	869
PL8SDK22E04C	36	2835 SMD	PCB	3600	2700 - 6500	600	600	97	7.0	1	468
PL8SDK14E04C	36	2835 SMD	PCB	3600	2700 - 6500	300	1200	97	6.5	1	450

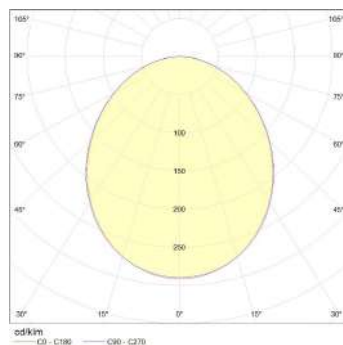
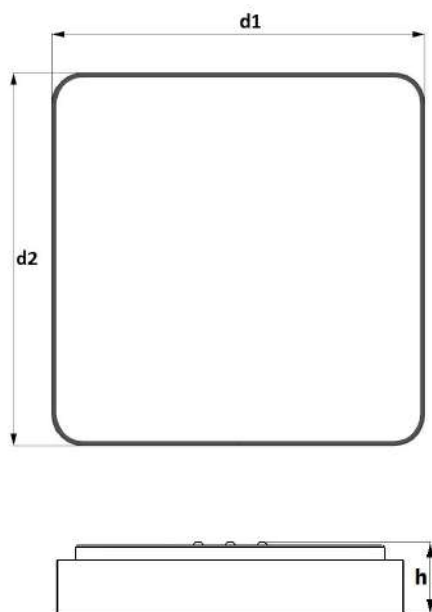

V / Hz 220 - 240 / 50 - 60

Options	Options
Dimmable electronic ballast or convertor. Emergency kit	Ballast électronique dimmable ou converteur. Kit d'urgence.
NOTE	NOTE
Given lumen values are net delivered luminaire output lumens.	Les valeurs de lumens données sont les lumens de sortie nets du luminaire.
Given power values are total consumed AC power of the luminaire.	Les valeurs de puissance données sont la puissance AC totale consommée du luminaire.



## GALAKSI YONCA

### LED

#### Suspended Lighting Fixtures With Frosted Diffuser

#### Luminaire suspendus Avec Diffuseur Givré

#### APPLICATION AREAS

Shopping Malls  
Supermarkets  
Offices  
Meeting rooms  
Stores  
Hospitals  
Schools  
Corridors

#### DOMAINES D'UTILISATION

Centres Commerciaux  
Supermarchés  
Bureaux  
Salles de Réunions  
Magasins  
Hopitaux  
Ecoles  
Couloirs

#### BODY

Anodized aluminum with satin finishing. Black and white color options with elegant design.

#### DIFFUSER

UV stabilized frosted diffuser.

#### CONVERTER

Long life, low power loss converter with constant current. Compatible with ENEC standards.

#### LED

LED modules with 60.000 hours lifetime LUMILEDS / SAMSUNG / NICHIA brand LEDs.

#### SUSPENSION

Composed of 1mm steel wire rope and nickel-plated brass components. Suspension height is adjustable. Supplied with transparent electric cord and ceiling mounted electrical junction box with aesthetic design

#### CORPS

Corps en aluminium anodisé, satiné. Design élégant. Couleurs blanc, noir disponibles.

#### DIFFUSEUR

Diffuseur givré. Anti UV.

#### CONVERTEUR

Convertisseur, conforme aux normes ENEC. Longue vie. Perte de puissance faible avec courant constant .

#### LED

Modules LED – Durée de vie 60.000 heures avec LED de marque LUMILEDS / SAMSUNG / NICHIA.

#### SYSTEME DE FIXATION

Composé d'un fil en acier de 1mm , de composants en laiton nickelés. Livré avec un cordon électrique transparent et une boîte de jonction électrique à fixer au plafond. Hauteur de fixation réglable.

Color Options  
Options de Couleur



LED Type / Type LED

Color Rendering Index / Indice de Rendu des Couleurs: (CRI): Ra>80

Kod Code	Power Puissance (W)	LED Type Type De LED	LED Module Module LED	Lum. Flux Flux Lum. (lm)	Color Temperature Température De Couleur (K)	Dimensions (mm)			Weight Poids (kg)	Packing Quantity Colisage	Pcs./20" Container Pcs./20" Conteneur	
						a	b	h				
PL8SY15C	19	2835 SMD	PCB	1850	2700 - 6500	494	539	94	5,5	1	600	

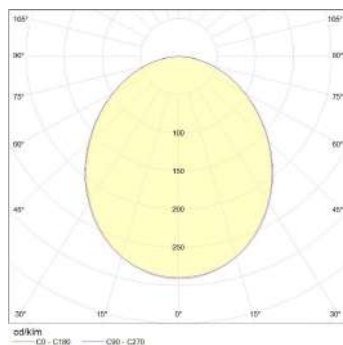
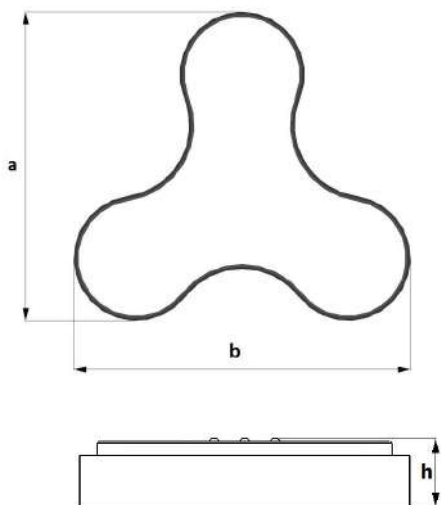

V / Hz 220 - 240 / 50 - 60

Options	Options
Dimmable electronic ballast or convertor. Emergency kit	Ballast électronique dimmable ou converteur. Kit d'urgence.
NOTE	NOTE
Given lumen values are net delivered luminaire output lumens.	Les valeurs de lumens données sont les lumens de sortie nets du luminaire.
Given power values are total consumed AC power of the luminaire.	Les valeurs de puissance données sont la puissance AC totale consommée du luminaire.

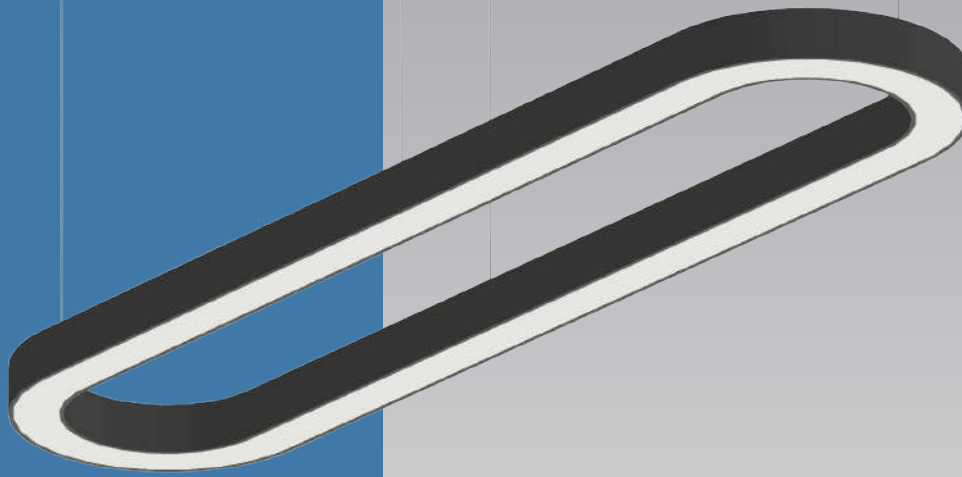

## GALAKSI OVAL

### LED

#### Suspended Lighting Fixtures With Frosted Diffuser

#### Luminaire suspendus Avec Diffuseur Givré

#### APPLICATION AREAS

Shopping Malls  
Supermarkets  
Offices  
Meeting rooms  
Stores  
Hospitals  
Schools  
Corridors

#### DOMAINES D'UTILISATION

Centres Commerciaux  
Supermarchés  
Bureaux  
Salles de Réunions  
Magasins  
Hopitaux  
Ecoles  
Couloirs

#### BODY

Anodized aluminum with satin finishing. Black and white color options with elegant design.

#### DIFFUSER

UV stabilized frosted diffuser.

#### CONVERTER

Long life, low power loss converter with constant current. Compatible with ENEC standards.

#### LED

LED modules with 60.000 hours lifetime LUMILEDS / SAMSUNG / NICHIA brand LEDs.

#### SUSPENSION

Composed of 1mm steel wire rope and nickel-plated brass components. Suspension height is adjustable. Supplied with transparent electric cord and ceiling mounted electrical junction box with aesthetic design

#### CORPS

Corps en aluminium anodisé, satiné. Design élégant. Couleurs blanc, noir disponibles.

#### DIFFUSEUR

Diffuseur givré. Anti UV.

#### CONVERTEUR

Convertisseur, conforme aux normes ENEC. Longue vie. Perte de puissance faible avec courant constant.

#### LED

Modules LED – Durée de vie 60.000 heures avec LED de marque LUMILEDS / SAMSUNG / NICHIA.

#### SYSTEME DE FIXATION

Composé d'un fil en acier de 1mm, de composants en laiton nickelés. Livré avec un cordon électrique transparent et une boîte de jonction électrique à fixer au plafond. Hauteur de fixation réglable.

Color Options  
Options de Couleur



LED Type / Type LED

Color Rendering Index / Indice de Rendu des Couleurs: (CRI): Ra>80

Kod Code	Power Puissance (W)	LED Type Type De LED	LED Module Module LED	Lum. Flux Flux Lum. (lm)	Color Temperature Température De Couleur (K)	Dimensions (mm)			Weight Poids (kg)	Packing Quantity Colisage	Pcs./20" Container Pcs./20" Conteneur
						a	l	h			
PL8SV8L15C	53	2835 SMD	PCB	5170	2700 - 6500	447	1010	73	5,5	1	430
PL8SV8L25C	80	2835 SMD	PCB	7780	2700 - 6500	447	1010	73	5,5	1	430
PL8SV10L15C	66	2835 SMD	PCB	6460	2700 - 6500	447	1290	73	7,5	1	340
PL8SV10L25C	100	2835 SMD	PCB	9725	2700 - 6500	447	1290	73	7,5	1	340
PL8SV12L15C	79	2835 SMD	PCB	7755	2700 - 6500	447	1571	73	9,0	1	280
PL8SV12L25C	120	2835 SMD	PCB	11670	2700 - 6500	447	1571	73	9,0	1	280
PL8SV14L15C	92	2835 SMD	PCB	9045	2700 - 6500	447	1851	73	11,0	1	240
PL8SV14L25C	140	2835 SMD	PCB	13615	2700 - 6500	447	1851	73	11,0	1	240

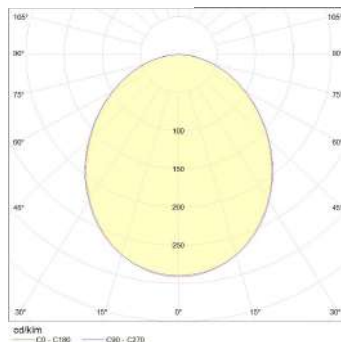
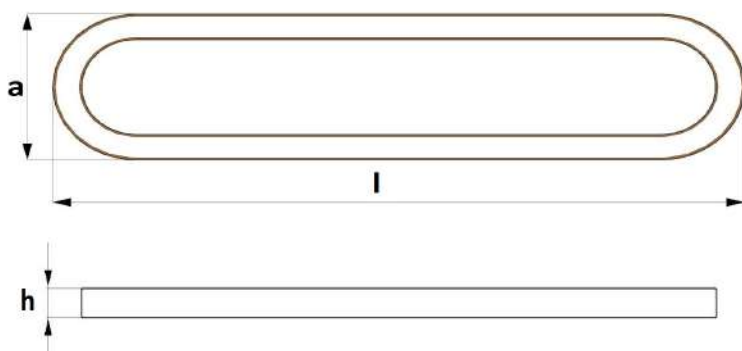

V / Hz 220 - 240 / 50 - 60

Options	Options
Dimmable electronic ballast or convertor. Emergency kit	Ballast électronique dimmable ou converteur. Kit d'urgence.
NOTE	NOTE
Given lumen values are net delivered luminaire output lumens.	Les valeurs de lumens données sont les lumens de sortie nets du luminaire.
Given power values are total consumed AC power of the luminaire.	Les valeurs de puissance données sont la puissance AC totale consommée du luminaire.

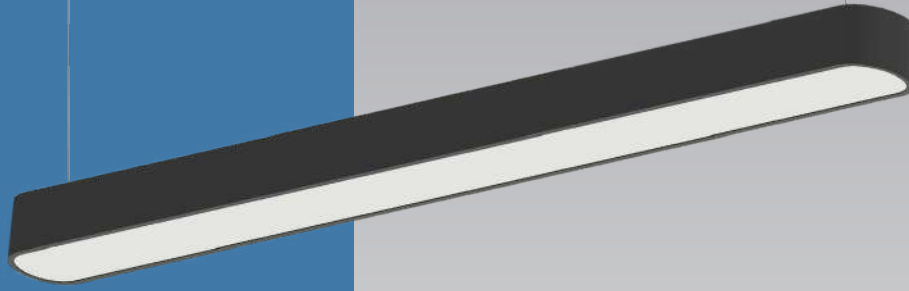

# GALAKSI LINEAR

## LED

### Suspended Lighting Fixtures With Frosted Diffuser

### Luminaire suspendus Avec Diffuseur Givré

#### APPLICATION AREAS

Shopping Malls  
Supermarkets  
Offices  
Meeting rooms  
Stores  
Hospitals  
Schools  
Corridors

#### DOMAINES D'UTILISATION

Centres Commerciaux  
Supermarchés  
Bureaux  
Salles de Réunions  
Magasins  
Hopitaux  
Ecoles  
Couloirs

#### BODY

Anodized aluminum with satin finishing. Black and white color options with elegant design.

#### DIFFUSER

UV stabilized frosted diffuser.

#### CONVERTER

Long life, low power loss converter with constant current. Compatible with ENEC standards.

#### LED

LED modules with 60.000 hours lifetime LUMILEDS / SAMSUNG / NICHIA brand LEDs.

#### SUSPENSION

Composed of 1mm steel wire rope and nickel-plated brass components. Suspension height is adjustable. Supplied with transparent electric cord and ceiling mounted electrical junction box with aesthetic design

#### CORPS

Corps en aluminium anodisé, satiné. Design élégant. Couleurs blanc, noir disponibles.

#### DIFFUSEUR

Diffuseur givré. Anti UV.

#### CONVERTEUR

Convertisseur, conforme aux normes ENEC. Longue vie. Perte de puissance faible avec courant constant .

#### LED

Modules LED – Durée de vie 60.000 heures avec LED de marque LUMILEDS / SAMSUNG / NICHIA.

#### SYSTEME DE FIXATION

Composé d'un fil en acier de 1mm , de composants en laiton nickelés. Livré avec un cordon électrique transparent et une boîte de jonction électrique à fixer au plafond. Hauteur de fixation réglable.

Color Options  
Options de Couleur



LED Type / Type LED

Color Rendering Index / Indice de Rendu des Couleurs: (CRI): Ra>80

Kod Code	Power Puissance (W)	LED Type Type De LED	LED Module Module LED	Lum. Flux Flux Lum. (lm)	Color Temperature Température De Couleur (K)	Dimensions (mm)			Weight Poids (kg)	Packing Quantity Colisage	Pcs./20" Container Pcs./20" Conteneur
						a	l	h			
PL8SL12L15C	14	2835 SMD	PCB	1295	2700 - 6500	90	598	73	1,8	1	4320
PL8SL12L25C	21	2835 SMD	PCB	1945	2700 - 6500	90	598	73	1,8	1	4320
PL8SL13L15C	21	2835 SMD	PCB	1940	2700 - 6500	90	879	73	2,4	1	4320
PL8SL13L25C	30	2835 SMD	PCB	2920	2700 - 6500	90	879	73	2,4	1	4320
PL8SL14L15C	26	2835 SMD	PCB	2585	2700 - 6500	90	1159	73	3,0	1	3060
PL8SL14L25C	41	2835 SMD	PCB	3890	2700 - 6500	90	1159	73	3,0	1	3060
PL8SL15L15C	33	2835 SMD	PCB	3230	2700 - 6500	90	1440	73	3,8	1	2460
PL8SL15L25C	51	2835 SMD	PCB	4865	2700 - 6500	90	1440	73	3,8	1	2460
PL8SL16L15C	39	2835 SMD	PCB	3880	2700 - 6500	90	1721	73	4,7	1	2270
PL8SL16L25C	61	2835 SMD	PCB	5835	2700 - 6500	90	1721	73	4,7	1	2270
PL8SL17L15C	47	2835 SMD	PCB	4525	2700 - 6500	90	2000	73	5,5	1	1870
PL8SL17L25C	70	2835 SMD	PCB	6810	2700 - 6500	90	2000	73	5,5	1	1870
PL8SL18L15C	53	2835 SMD	PCB	5170	2700 - 6500	90	2282	73	6,2	1	1870
PL8SL19L15C	60	2835 SMD	PCB	5815	2700 - 6500	90	2562	73	6,9	1	1490
PL8SL10L15C	66	2835 SMD	PCB	6460	2700 - 6500	90	2843	73	7,6	1	1480

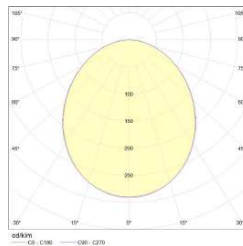
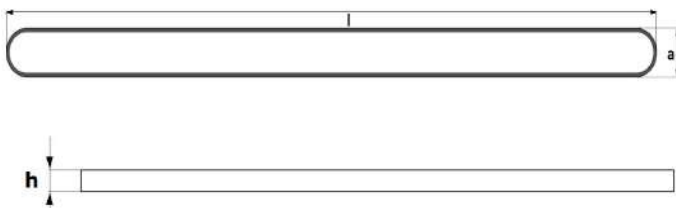

V / Hz 220 - 240 / 50 - 60

Options	Options
Dimmable electronic ballast or convertor. Emergency kit	Ballast électronique dimmable ou converteur. Kit d'urgence.
<b>NOTE</b>	<b>NOTE</b>
Given lumen values are net delivered luminaire output lumens.	Les valeurs de lumens données sont les lumens de sortie nets du luminaire.
Given power values are total consumed AC power of the luminaire.	Les valeurs de puissance données sont la puissance AC totale consommée du luminaire.



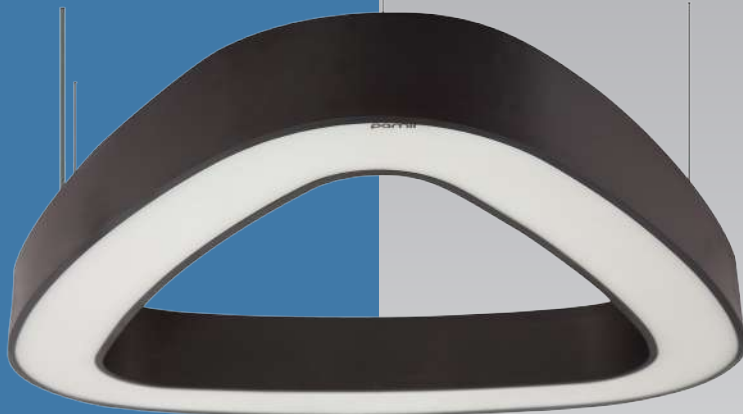

## GALAKSI TRILINE

### LED

#### Suspended Lighting Fixtures With Frosted Diffuser

#### Luminaire Suspendus Avec Diffuseur Givré

#### APPLICATION AREAS

Shopping Malls  
Supermarkets  
Offices  
Meeting rooms  
Stores  
Hospitals  
Schools  
Corridors

#### DOMAINES D'UTILISATION

Centres Commerciaux  
Supermarchés  
Bureaux  
Salles de Réunions  
Magasins  
Hopitaux  
Ecoles  
Couloirs

#### BODY

Anodized aluminum with satin finishing. Black and white color options with elegant design.

#### DIFFUSER

UV stabilized frosted diffuser.

#### CONVERTER

Long life, low power loss converter with constant current. Compatible with ENEC standards.

#### LED

LED modules with 60.000 hours lifetime LUMILEDS / SAMSUNG / NICHIA brand LEDs.

#### SUSPENSION

Composed of 1mm steel wire rope and nickel-plated brass components. Suspension height is adjustable. Supplied with transparent electric cord and ceiling mounted electrical junction box with aesthetic design

#### CORPS

Corps en aluminium anodisé, satiné. Design élégant. Couleurs blanc, noir disponibles.

#### DIFFUSEUR

Diffuseur givré. Anti UV.

#### CONVERTEUR

Convertisseur, conforme aux normes ENEC. Longue vie. Perte de puissance faible avec courant constant.

#### LED

Modules LED – Durée de vie 60.000 heures avec LED de marque LUMILEDS / SAMSUNG / NICHIA.

#### SYSTEME DE FIXATION

Composé d'un fil en acier de 1mm, de composants en laiton nickelés. Livré avec un cordon électrique transparent et une boîte de jonction électrique à fixer au plafond. Hauteur de fixation réglable.

Color Options  
Options de Couleur



LED Type / Type LED

Color Rendering Index / Indice de Rendu des Couleurs: (CRI): Ra>80

Code	Power Puissance (W)	LED Type Type De LED	LED Module Module LED	Lum. Flux Flux Lum. (lm)	Color Temperature Température De Couleur (K)	Dimensions (mm) d h		Weight Poids (kg)	Packing Quantity Colisage	Pcs./20" Container Pcs./20" Conteneur
PL8ST6L15C	39	2835 SMD	PCB	3880	2700 - 6500	625	73	4.2	1	550
PL8ST6L25C	61	2835 SMD	PCB	5835	2700 - 6500	625	73	4.3	1	550
PL8ST9L15C	60	2835 SMD	PCB	5815	2700 - 6500	905	73	6.1	1	270
PL8ST9L25C	90	2835 SMD	PCB	8755	2700 - 6500	905	73	6.3	1	270
PL8ST12L15C	79	2835 SMD	PCB	7755	2700 - 6500	1183	73	8.1	1	160
PL8ST12L25C	120	2835 SMD	PCB	11670	2700 - 6500	1183	73	8.3	1	160

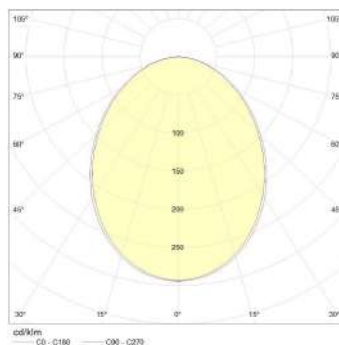
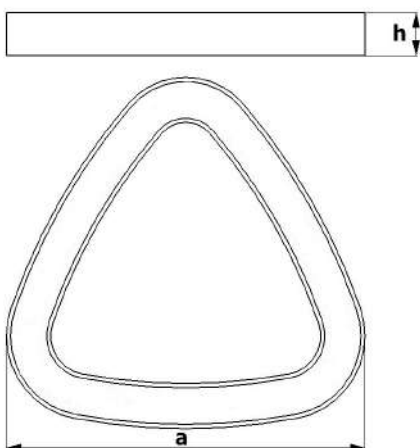

V / Hz 220 - 240 / 50 - 60

Options	Options
Dimmable electronic ballast or convertor. Emergency kit	Ballast électronique dimmable ou converteur. Kit d'urgence.
NOTE	NOTE
Given lumen values are net delivered luminaire output lumens.	Les valeurs de lumens données sont les lumens de sortie nets du luminaire.
Given power values are total consumed AC power of the luminaire.	Les valeurs de puissance données sont la puissance AC totale consommée du luminaire.



# GALAKSI DOLUNAY RECESSED

## LED

### Recessed Lighting Fixtures With Frosted Diffuser

### Luminaire Encastre Avec Diffuseur Givré

#### APPLICATION AREAS

Shopping Malls  
Supermarkets  
Offices  
Meeting rooms  
Stores  
Hospitals  
Schools

#### DOMAINES D'UTILISATION

Centres Commerciaux  
Supermarchés  
Bureaux  
Salles de Réunions  
Magasins  
Hopitaux  
Ecoles

#### BODY

Anodized aluminum with satin finishing. Black and white color options with elegant design.

#### DIFFUSER

UV stabilized frosted diffuser.

#### CONVERTER

Long life, low power loss converter with constant current. Compatible with ENEC standards.

#### LED

LED modules with 60.000 hours lifetime LUMILEDS / SAMSUNG / NICHIA brand LEDs.

#### CORPS

Corps en aluminium anodisé, satiné. Design élégant. Couleurs blanc, noir disponibles.

#### DIFFUSEUR

Diffuseur givré. Anti UV.

#### CONVERTEUR

Convertisseur, conforme aux normes ENEC. Longue vie. Perte de puissance faible avec courant constant.

#### LED

Modules LED – Durée de vie 60.000 heures avec LED de marque LUMILEDS / SAMSUNG / NICHIA.

Color Options  
Options de Couleur



LED Type / Type LED

Color Rendering Index / Indice de Rendu des Couleurs: (CRI): Ra>80

Code	Power Puissance (W)	LED Type Type De LED	LED Module Module LED	Lum. Flux Flux Lum. (lm)	Color Temperature Température De Couleur (K)	Dimensions (mm)			Weight Poids (kg)	Packing Quantity Colisage	Pcs./20" Container Pcs./20" Conteneur
						d1	d2	h			
PL8AD25E15C	27	2835 SMD	PCB	2585	2700 - 6500	490	475	93	5.0	1	678
PL8AD38E15C	40	2835 SMD	PCB	3880	2700 - 6500	620	605	93	6.3	1	440
PL8AD80E15C	83	2835 SMD	PCB	8185	2700 - 6500	920	905	93	7.0	1	210
PL8AD143E15C	147	2835 SMD	PCB	14645	2700 - 6500	1220	1205	93	9.1	1	122

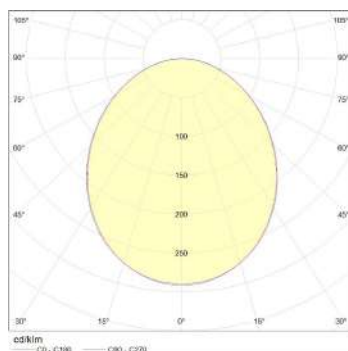
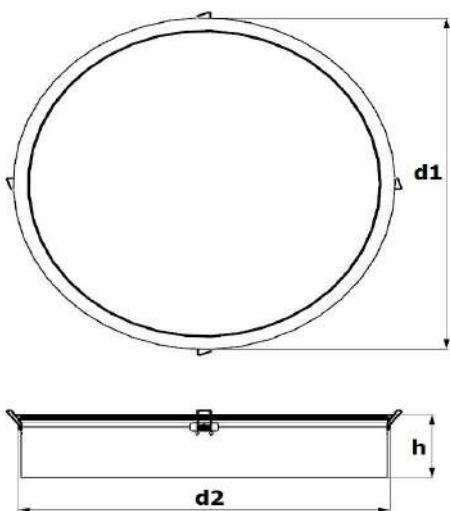

V / Hz 220 - 240 / 50 - 60

Options	Options
Dimmable electronic ballast or convertor. Emergency kit	Ballast électronique dimmable ou converteur. Kit d'urgence.
NOTE	NOTE
Given lumen values are net delivered luminaire output lumens.	Les valeurs de lumens données sont les lumens de sortie nets du luminaire.
Given power values are total consumed AC power of the luminaire.	Les valeurs de puissance données sont la puissance AC totale consommée du luminaire.



# GALAKSI TRIMLESS DOLUNAY

## LED

Recessed Lighting Fixtures With Frosted Diffuser

Luminaire Encastre Avec Diffuseur Givré

### APPLICATION AREAS

Shopping Malls  
Supermarkets  
Offices  
Meeting rooms  
Stores  
Hospitals  
Schools

### DOMAINES D'UTILISATION

Centres Commerciaux  
Supermarchés  
Bureaux  
Salles de Réunions  
Magasins  
Hopitaux  
Ecoles

#### BODY

Anodized aluminum with satin finishing. Black and white color options with elegant design.

#### DIFFUSER

UV stabilized frosted diffuser.

#### CONVERTER

Long life, low power loss converter with constant current. Compatible with ENEC standards.

#### LED

LED modules with 60.000 hours lifetime LUMILEDS / SAMSUNG / NICHIA brand LEDs.

#### CORPS

Corps en aluminium anodisé, satiné. Design élégant. Couleurs blanc, noir disponibles.

#### DIFFUSEUR

Diffuseur givré. Anti UV.

#### CONVERTEUR

Convertisseur, conforme aux normes ENEC. Longue vie. Perte de puissance faible avec courant constant.

#### LED

Modules LED – Durée de vie 60.000 heures avec LED de marque LUMILEDS / SAMSUNG / NICHIA.

Ceiling Mounting System  
Système de Montage au Plafond



Color Options  
Options de Couleur



LED Type / Type LED

Color Rendering Index / Indice de Rendu des Couleurs: (CRI): Ra>80

Code	Power Puissance (W)	LED Type Type De LED	LED Module Module LED	Lum. Flux Flux Lum. (lm)	Color Temperature Température De Couleur (K)	Dimensions (mm) d h		Weight Poids (kg)	Packing Quantity Colisage	Pcs./20" Container Pcs./20" Conteneur
PL8ATD17E15C	18	2835 SMD	PCB	1725	2700 - 6500	360	97	2.9	1	1176
PL8ATD25E15C	27	2835 SMD	PCB	2585	2700 - 6500	470	97	5.0	1	730
PL8ATD38E15C	40	2835 SMD	PCB	3880	2700 - 6500	600	97	6.3	1	470
PL8ATD80E15C	83	2835 SMD	PCB	8185	2700 - 6500	900	97	7.0	1	220
PL8ATD143E15C	147	2835 SMD	PCB	14645	2700 - 6500	1200	97	9.1	1	125

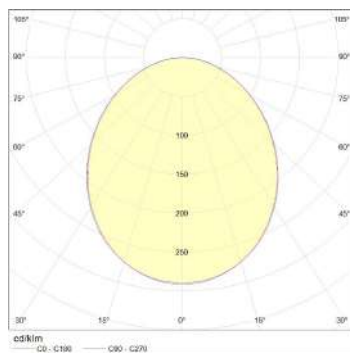
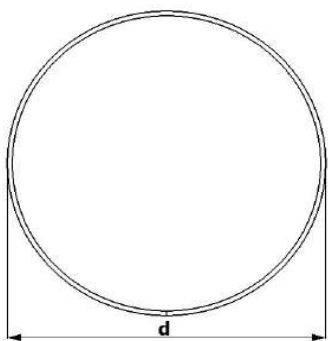

V / Hz 220 - 240 / 50 - 60

Options	Options
Dimmable electronic ballast or convertor. Emergency kit	Ballast électronique dimmable ou converteur. Kit d'urgence.
NOTE	NOTE
Given lumen values are net delivered luminaire output lumens.	Les valeurs de lumens données sont les lumens de sortie nets du luminaire.
Given power values are total consumed AC power of the luminaire.	Les valeurs de puissance données sont la puissance AC totale consommée du luminaire.

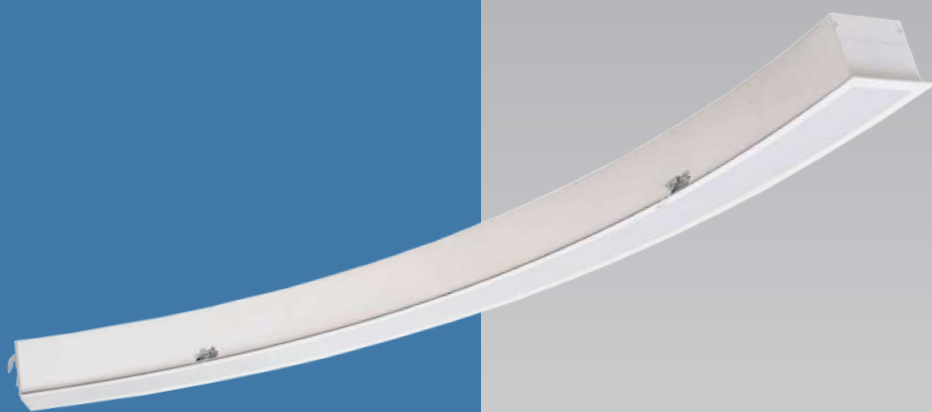

# GALAKSI FREEDOM RECESSED

## LED

### Recessed Lighting Fixtures With Frosted Diffuser

### Luminaire Encastré Avec Diffuseur Givré

#### APPLICATION AREAS

Shopping Malls  
Supermarkets  
Offices  
Meeting rooms  
Stores  
Hospitals  
Schools

#### DOMAINES D'UTILISATION

Centres Commerciaux  
Supermarchés  
Bureaux  
Salles de Réunions  
Magasins  
Hopitaux  
Ecoles

#### BODY

Anodized aluminum with satin finishing. Black and white color options with elegant design.

#### DIFFUSER

UV stabilized frosted diffuser.

#### CONVERTER

Long life, low power loss converter with constant current. Compatible with ENEC standards.

#### LED

LED modules with 60.000 hours lifetime LUMILEDS / SAMSUNG / NICHIA brand LEDs.

#### CORPS

Corps en aluminium anodisé, satiné. Design élégant. Couleurs blanc, noir disponibles.

#### DIFFUSEUR

Diffuseur givré. Anti UV.

#### CONVERTEUR

Convertisseur, conforme aux normes ENEC. Longue vie. Perte de puissance faible avec courant constant.

#### LED

Modules LED – Durée de vie 60.000 heures avec LED de marque LUMILEDS / SAMSUNG / NICHIA.

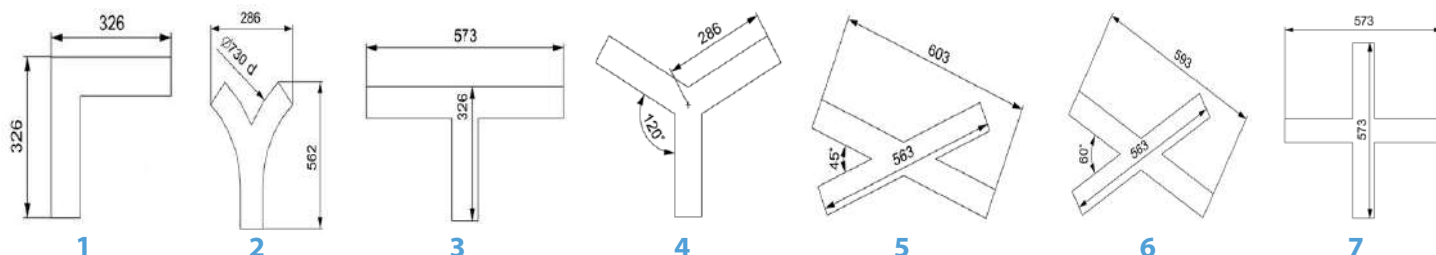

Color Options  
Options de Couleur



LED Type / Type LED

Color Rendering Index / Indice de Rendu des Couleurs: (CRI): Ra>80

Code	Power Puissance (W)	LED Type Type De LED	LED Module Module LED	Lum. Flux Flux Lum. (lm)	Color Temperature Température De Couleur (K)	Dimensions (mm)			Weight Poids (kg)	Shape La Forme
						a	d	h		
PL8A180F4L15C	26	2835 SMD	PCB	2550	2700 - 6500	84	800	84	2,6	
PL8A180F6L15C	39	2835 SMD	PCB	3820	2700 - 6500	84	1155	84	3,9	
PL8A180F8L15C	53	2835 SMD	PCB	5095	2700 - 6500	84	1500	84	5,1	
PL8A180F10L15C	66	2835 SMD	PCB	6365	2700 - 6500	84	1890	84	5,9	
PL8A180F12L15C	79	2835 SMD	PCB	7640	2700 - 6500	84	2255	84	6,7	
PL8A180F14L15C	92	2835 SMD	PCB	8915	2700 - 6500	84	2610	84	7,7	
PL8A180F16L15C	105	2835 SMD	PCB	10185	2700 - 6500	84	2950	84	8,6	
PL8A90F2L15C	14	2835 SMD	PCB	1275	2700 - 6500	84	800	84	1,5	
PL8A90F3L15C	21	2835 SMD	PCB	1910	2700 - 6500	84	1155	84	2,0	
PL8A90F4L15C	26	2835 SMD	PCB	2550	2700 - 6500	84	1500	84	2,6	
PL8A90F5L15C	33	2835 SMD	PCB	3185	2700 - 6500	84	1890	84	3,3	
PL8A90F6L15C	39	2835 SMD	PCB	3820	2700 - 6500	84	2255	84	3,9	
PL8A90F7L15C	47	2835 SMD	PCB	4455	2700 - 6500	84	2610	84	4,5	
PL8A90F8L15C	53	2835 SMD	PCB	5095	2700 - 6500	84	2950	84	5,1	
PL8A90F9L15C	60	2835 SMD	PCB	5730	2700 - 6500	84	3315	84	5,5	
PL8A90F10L15C	66	2835 SMD	PCB	6365	2700 - 6500	84	3675	84	5,9	
PL8A45F1L15C	8	2835 SMD	PCB	640	2700 - 6500	84	800	84	1,5	
PL8A45F2L15C	14	2835 SMD	PCB	1275	2700 - 6500	84	1500	84	1,5	
PL8A45F3L15C	21	2835 SMD	PCB	1910	2700 - 6500	84	2255	84	2,0	
PL8A45F4L15C	26	2835 SMD	PCB	2550	2700 - 6500	84	2950	84	2,6	
PL8A45F5L15C	33	2835 SMD	PCB	3185	2700 - 6500	84	3675	84	3,3	
PL8ALF1L15C	8	2835 SMD	PCB	640	2700 - 6500	84	282	84	1,5	
PL8ALF2L15C	14	2835 SMD	PCB	1275	2700 - 6500	84	565	84	1,5	
PL8ALF3L15C	21	2835 SMD	PCB	1910	2700 - 6500	84	845	84	2,0	
PL8ALF4L15C	26	2835 SMD	PCB	2550	2700 - 6500	84	1125	84	2,6	
PL8ALF5L15C	33	2835 SMD	PCB	3185	2700 - 6500	84	1405	84	3,3	
PL8ALF6L15C	39	2835 SMD	PCB	3820	2700 - 6500	84	1685	84	3,9	
PL8ALF7L15C	47	2835 SMD	PCB	4455	2700 - 6500	84	1965	84	4,5	
PL8ALF8L15C	53	2835 SMD	PCB	5095	2700 - 6500	84	2254	84	5,1	
PL8ALF9L15C	60	2835 SMD	PCB	5730	2700 - 6500	84	2525	84	5,5	
PL8ALF10L15C	66	2835 SMD	PCB	6365	2700 - 6500	84	2810	84	5,9	
Code	Power Puissance (W)	LED Type Type De LED	LED Module Module LED	Lum. Flux Flux Lum. (lm)	Color Temperature Température De Couleur (K)	Dimensions (mm)		Weight Poids (kg)	Drawing No Dessin No	
						a	h			
PL8ACF2L15C	14	2835 SMD	PCB	1275	2700 - 6500	84	84	1,5	1	
PL8AA3FL15C	21	2835 SMD	PCB	1910	2700 - 6500	84	84	2,0	2	
PL8AT3FL15C	21	2835 SMD	PCB	1910	2700 - 6500	84	84	2,0	3	
PL8AY3FL15C	21	2835 SMD	PCB	1910	2700 - 6500	84	84	2,0	4	
PL8A45K4FL15C	26	2835 SMD	PCB	2550	2700 - 6500	84	84	2,6	5	
PL8A60K4FL15C	26	2835 SMD	PCB	2550	2700 - 6500	84	84	2,6	6	
PL8A90K4FL15C	26	2835 SMD	PCB	2550	2700 - 6500	84	84	2,6	7	

Visible Frame Width / Largeur de Cadre Visible: 95mm





## GALAKSI O RECESSED

### LED

#### Recessed Lighting Fixtures With Frosted Diffuser

#### Luminaire Encastre Avec Diffuseur Givré

##### BODY

Anodized aluminum with satin finishing. Black and white color options with elegant design.

##### DIFFUSER

UV stabilized frosted diffuser.

##### CONVERTER

Long life, low power loss converter with constant current. Compatible with ENEC standards.

##### LED

LED modules with 60.000 hours lifetime LUMILEDS / SAMSUNG / NICHIA brand LEDs.

##### APPLICATION AREAS

Shopping Malls  
Supermarkets  
Offices  
Meeting rooms  
Stores  
Hospitals  
Schools

##### DOMAINES D'UTILISATION

Centres Commerciaux  
Supermarchés  
Bureaux  
Salles de Réunions  
Magasins  
Hopitaux  
Ecoles

##### CORPS

Corps en aluminium anodisé, satiné. Design élégant. Couleurs blanc, noir disponibles.

##### DIFFUSEUR

Diffuseur givré. Anti UV.

##### CONVERTEUR

Convertisseur, conforme aux normes ENEC. Longue vie. Perte de puissance faible avec courant constant .

##### LED

Modules LED – Durée de vie 60.000 heures avec LED de marque LUMILEDS / SAMSUNG / NICHIA.

Color Options  
Options de Couleur



LED Type / Type LED

Color Rendering Index / Indice de Rendu des Couleurs: (CRI): Ra>80

Code	Power Puissance (W)	LED Type Type De LED	LED Module Module LED	Lum. Flux Flux Lum. (lm)	Color Temperature Température De Couleur (K)	Dimensions (mm)				Weight Poids (kg)	Packing Quantity Colisage	Pcs./20" Container Pcs./20" Conteneur
						D	d1	d2	h			
PL8A08L15C	53	2835 SMD	PCB	5170	2700 - 6500	820	807	635	84	6.5	1	260
PL8A010L15C	66	2835 SMD	PCB	6460	2700 - 6500	1000	987	815	84	7.2	1	180
PL8A012L15C	79	2835 SMD	PCB	7755	2700 - 6500	1175	1162	990	84	9.3	1	130
PL8A014L15C	92	2835 SMD	PCB	9045	2700 - 6500	1355	1342	1170	84	10.5	1	100
PL8A016L15C	105	2835 SMD	PCB	10340	2700 - 6500	1520	1507	1335	84	11.7	1	80
PL8A020L15C	132	2835 SMD	PCB	12920	2700 - 6500	1910	1897	1725	84	12.9	1	50
PL8A024L15C	158	2835 SMD	PCB	15505	2700 - 6500	2275	2262	2090	84	14.1	1	35

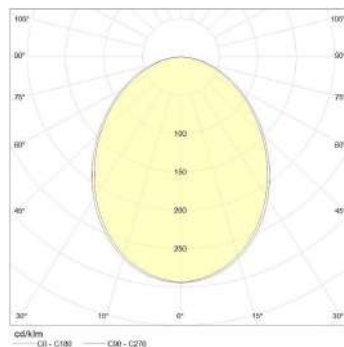
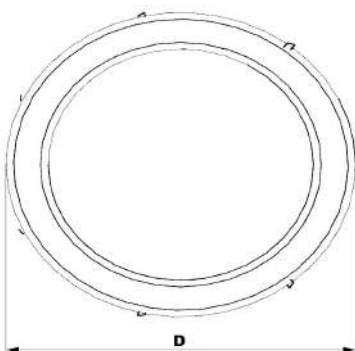
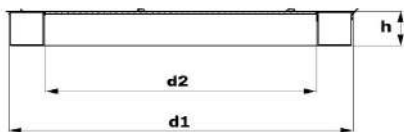

V / Hz 220 - 240 / 50 - 60

Options	Options
Dimmable electronic ballast or convertor.	Ballast électronique dimmable ou converteur.
Emergency kit	Kit d'urgence.
NOTE	NOTE
Given lumen values are net delivered luminaire output lumens.	Les valeurs de lumens données sont les lumens de sortie nets du luminaire.
Given power values are total consumed AC power of the luminaire.	Les valeurs de puissance données sont la puissance AC totale consommée du luminaire.





**ELITE**



# ELITE DAISY DIRECT / INDIRECT

## LED

### Suspended Lighting Fixtures With Lens

### Luminaire suspendus Avec Lentille

#### BODY

Anodized aluminum with satin finishing. Black and white color options with elegant design.

#### LENS

With 50° or 80° lens.

#### DIFFUSER

UV stabilized frosted diffuser.

#### CONVERTER

Compatible with ENEC standards.

#### LED

LED modules with 60.000 hours lifetime LUMILEDS / SAMSUNG / NICHIA brand LEDs.

#### SUSPENSION

Composed of 1mm steel wire rope and nickel-plated brass components. Suspension height is adjustable. Supplied with transparent electric cord and ceiling mounted electrical junction box with aesthetic design.

#### CORPS

Corps en aluminium anodisé, satiné. Design élégant. Couleurs blanc, noir disponibles.

#### LENS

Avec lentille 50° ou 80°.

#### DIFFUSEUR

Diffuseur givré. Anti UV.

#### CONVERTEUR

Convertisseur, conforme aux normes ENEC.

#### LED

Modules LED – Durée de vie 60.000 heures avec LED de marque LUMILEDS / SAMSUNG / NICHIA.

#### SYSTEME DE FIXATION

Composé d'un fil en acier de 1mm, de composants en laiton nickelés. Livré avec un cordon électrique transparent et une boîte de jonction électrique à fixer au plafond. Hauteur de fixation réglable.

#### APPLICATION AREAS

Shopping Malls  
Supermarkets  
Offices  
Meeting rooms  
Stores  
Hospitals  
Schools  
Corridors

#### DOMAINES D'UTILISATION

Centres Commerciaux  
Supermarchés  
Bureaux  
Salles de Réunions  
Magasins  
Hopitaux  
Ecoles  
Couloirs

V / Hz 220 - 240 / 50 - 60

Options	Options	NOTE	NOTE
Dimmable electronic ballast or convertor.	Ballast électronique dimmable ou converteur.	Given lumen values are net delivered luminaire output lumens.	Les valeurs de lumens données sont les lumens de sortie nets du luminaire.
Emergency kit	Kit d'urgence.	Given power values are total consumed AC power of the luminaire.	Les valeurs de puissance données sont la puissance AC totale consommée du luminaire.

Indirect Lighting  
Éclairage Indirect

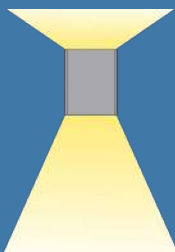

Direct Lighting  
Éclairage Direct



Color Options  
Options de Couleur



Direct / LED Type / Type LED

Color Rendering Index / Indice de Rendu des Couleurs: (CRI): Ra>80

Code	Power Puissance (W)	LED Type Type De LED	LED Module Module LED	Lum. Flux Flux Lum. (lm)	Color Temperature Température De Couleur (K)	Dimensions (mm)			Weight Poids (kg)	Packing Quantity Colisage	Pcs./20" Container Pcs./20" Conteneur
						a	l	h			
PL10S12L15C	16	2835 SMD	PCB	2000	2700 - 6500	47	578	73	1.2	2	3635
PL10S13L15C	22	2835 SMD	PCB	2995	2700 - 6500	47	858	73	1.7	2	3635
PL10S14L15C	29	2835 SMD	PCB	3995	2700 - 6500	47	1138	73	2.3	2	2835
PL10S15L15C	37	2835 SMD	PCB	4995	2700 - 6500	47	1418	73	2.9	2	2295
PL10S16L15C	44	2835 SMD	PCB	5990	2700 - 6500	47	1698	73	3.5	2	1970
PL10S17L15C	52	2835 SMD	PCB	6990	2700 - 6500	47	1978	73	4.0	2	1560
PL10S18L15C	60	2835 SMD	PCB	7985	2700 - 6500	47	2258	73	4.6	2	1560
PL10S19L15C	66	2835 SMD	PCB	8985	2700 - 6500	47	2538	73	5.2	2	1560
PL10S10L15C	75	2835 SMD	PCB	9985	2700 - 6500	47	2818	73	5.7	2	1255

In-Direct / LED Type / Type LED

Color Rendering Index / Indice de Rendu des Couleurs: (CRI): Ra>80

Code	Power Puissance (W)	LED Type Type De LED	LED Module Module LED	Lum. Flux Flux Lum. (lm)	Color Temperature Température De Couleur (K)	Dimensions (mm)			Weight Poids (kg)	Packing Quantity Colisage	Pcs./20" Container Pcs./20" Conteneur
						a	l	h			
PL10ES21L15C	16/8	2835 SMD	PCB	2000/665	2700 - 6500	47	578	73	1.3	2	3635
PL10ES32L15C	22/14	2835 SMD	PCB	2995/1330	2700 - 6500	47	858	73	1.8	2	3635
PL10ES43L15C	29/21	2835 SMD	PCB	3995/1995	2700 - 6500	47	1138	73	2.4	2	2835
PL10ES54L15C	37/26	2835 SMD	PCB	4995/2660	2700 - 6500	47	1418	73	3.0	2	2295
PL10ES65L15C	44/33	2835 SMD	PCB	5990/3325	2700 - 6500	47	1698	73	3.8	2	1970
PL10ES76L15C	52/39	2835 SMD	PCB	6990/3990	2700 - 6500	47	1978	73	4.3	2	1560
PL10ES87L15C	60/47	2835 SMD	PCB	7985/4655	2700 - 6500	47	2258	73	4.9	2	1560
PL10ES98L15C	66/53	2835 SMD	PCB	8985/5320	2700 - 6500	47	2538	73	5.8	2	1560
PL10ES109L15C	75/60	2835 SMD	PCB	9985/5985	2700 - 6500	47	2818	73	6.3	2	1255

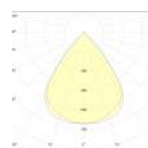
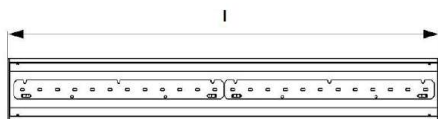
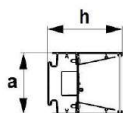

80° Light Beam

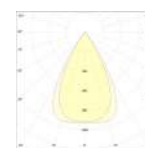

50° Light Beam

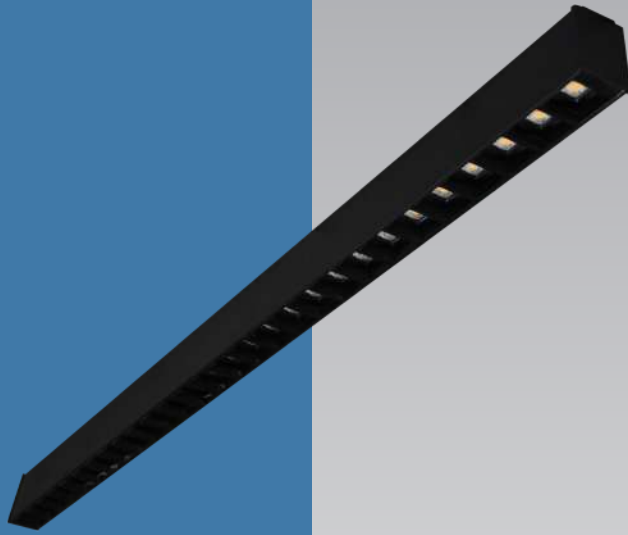

# ELITE DAISY

## LED

### Surface Mounted Lighting Fixtures With Lens

### Luminaire Apparents Avec Lentille

#### APPLICATION AREAS

Shopping Malls  
Supermarkets  
Offices  
Meeting rooms  
Stores  
Hospitals  
Schools  
Corridors

#### DOMAINES D'UTILISATION

Centres Commerciaux  
Supermarchés  
Bureaux  
Salles de Réunions  
Magasins  
Hopitaux  
Ecoles  
Couloirs

#### BODY

Anodized aluminum with satin finishing. Black and white color options with elegant design.

#### LENS

With 50° or 80° lens.

#### DIFFUSER

UV stabilized frosted diffuser.

#### CONVERTER

Compatible with ENEC standards.

#### LED

LED modules with 60.000 hours lifetime LUMILEDS / SAMSUNG / NICHIA brand LEDs.

#### CORPS

Corps en aluminium anodisé, satiné. Design élégant. Couleurs blanc, noir disponibles.

#### LENS

Avec lentille 50° ou 80°.

#### DIFFUSEUR

Diffuseur givré. Anti UV.

#### CONVERTEUR

Convertisseur, conforme aux normes ENEC.

#### LED

Modules LED – Durée de vie 60.000 heures avec LED de marque LUMILEDS / SAMSUNG / NICHIA.



Color Options  
Options de Couleur



LED Type / Type LED

Color Rendering Index / Indice de Rendu des Couleurs: (CRI): Ra>80

Code	Power Puissance (W)	LED Type Type De LED	LED Module Module LED	Lum. Flux Flux Lum. (lm)	Color Temperature Température De Couleur (K)	Dimensions (mm)			Weight Poids (kg)	Packing Quantity Colisage	Pcs./20" Container Pcs./20" Conteneur
						a	l	h			
PL10U12L15C	16	2835 SMD	PCB	2000	2700 - 6500	47	578	73	1.2	2	3635
PL10U13L15C	22	2835 SMD	PCB	2995	2700 - 6500	47	858	73	1.7	2	3635
PL10U14L15C	29	2835 SMD	PCB	3995	2700 - 6500	47	1138	73	2.3	2	2835
PL10U15L15C	37	2835 SMD	PCB	4995	2700 - 6500	47	1418	73	2.9	2	2295
PL10U16L15C	44	2835 SMD	PCB	5990	2700 - 6500	47	1698	73	3.5	2	1970
PL10U17L15C	52	2835 SMD	PCB	6990	2700 - 6500	47	1978	73	4.0	2	1560
PL10U18L15C	60	2835 SMD	PCB	7985	2700 - 6500	47	2258	73	4.6	2	1560
PL10U19L15C	66	2835 SMD	PCB	8985	2700 - 6500	47	2538	73	5.2	2	1560
PL10U10L15C	75	2835 SMD	PCB	9985	2700 - 6500	47	2818	73	5.7	2	1255

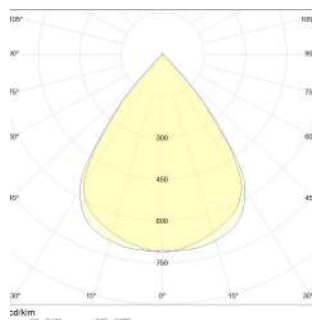
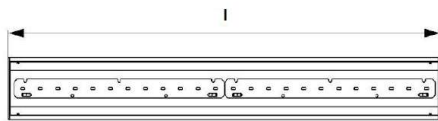
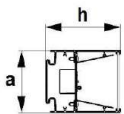

80° Light Beam

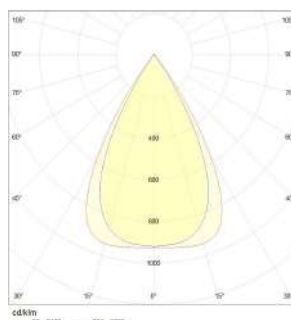

50° Light Beam

V / Hz 220 - 240 / 50 - 60

Options	Options
Dimmable electronic ballast or convertor. Emergency kit	Ballast électronique dimmable ou converteur. Kit d'urgence.
NOTE	NOTE
Given lumen values are net delivered luminaire output lumens.	Les valeurs de lumens données sont les lumens de sortie nets du luminaire.
Given power values are total consumed AC power of the luminaire.	Les valeurs de puissance données sont la puissance AC totale consommée du luminaire.



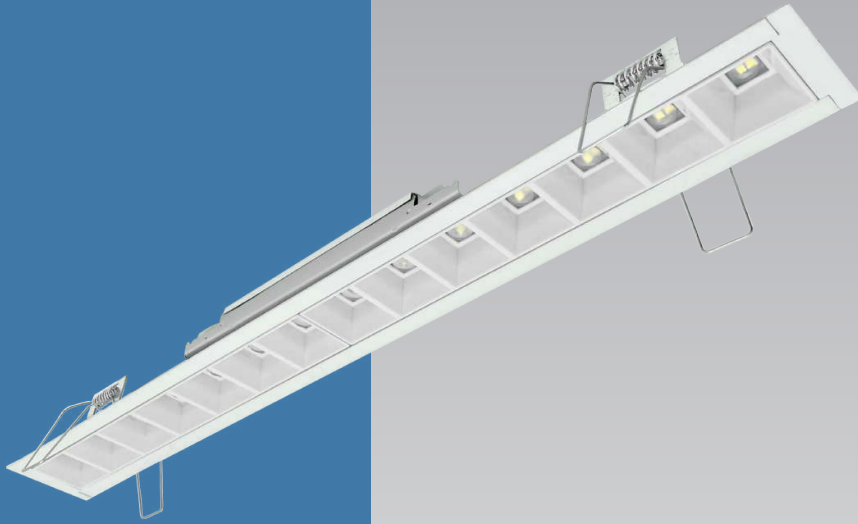

# ELITE DAISY LINEAR RECESSED

## LED

### Recessed Lighting Fixtures With Lens

### Luminaire Encastrés Avec Lentille

#### BODY

Anodized aluminum with satin finishing. Black and white color options with elegant design.

#### LENS

With 50° or 80° lens.

#### DIFFUSER

UV stabilized frosted diffuser.

#### CONVERTER

Compatible with ENEC standards.

#### LED

LED modules with 60.000 hours lifetime LUMILEDS / SAMSUNG / NICHIA brand LEDs.

#### CORPS

Corps en aluminium anodisé, satiné. Design élégant. Couleurs blanc, noir disponibles.

#### LENS

Avec lentille 50 ° ou 80 °.

#### DIFFUSEUR

Diffuseur givré. Anti UV.

#### CONVERTEUR

Convertisseur, conforme aux normes ENEC.

#### LED

Modules LED – Durée de vie 60.000 heures avec LED de marque LUMILEDS / SAMSUNG / NICHIA.

#### APPLICATION AREAS

Shopping Malls  
Supermarkets  
Offices  
Meeting rooms  
Stores  
Hospitals  
Schools  
Corridors

#### DOMAINES D'UTILISATION

Centres Commerciaux  
Supermarchés  
Bureaux  
Salles de Réunions  
Magasins  
Hopitaux  
Ecoles  
Couloirs

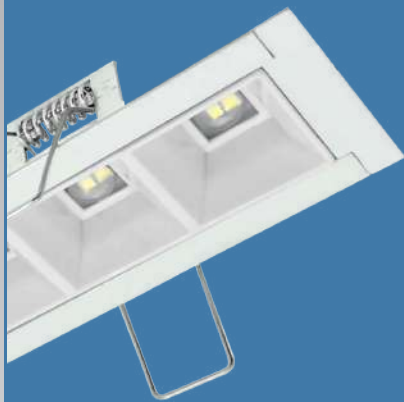

Color Options  
Options de Couleur



LED Type / Type LED

Color Rendering Index / Indice de Rendu des Couleurs: (CRI): Ra>80

Code	Power Puissance (W)	LED Type Type De LED	LED Module Module LED	Lum. Flux Flux Lum. (lm)	Color Temperature Température De Couleur (K)	Dimensions (mm)			Weight Poids (kg)	Packing Quantity Colisage	Pcs./20" Container Pcs./20" Conteneur
						a	l	h			
PL10A11L15C	10	2835 SMD	PCB	1000	2700 - 6500	53	287	50	1.2	2	12690
PL10A12L15C	16	2835 SMD	PCB	2000	2700 - 6500	53	567	50	1.7	2	7824
PL10A13L15C	22	2835 SMD	PCB	2995	2700 - 6500	53	847	50	2.3	2	4230
PL10A14L15C	29	2835 SMD	PCB	3995	2700 - 6500	53	1127	50	2.9	2	3510
PL10A15L15C	37	2835 SMD	PCB	4995	2700 - 6500	53	1407	50	3.5	2	3423
PL10A16L15C	44	2835 SMD	PCB	5990	2700 - 6500	53	1687	50	4.1	2	2280
PL10A17L15C	52	2835 SMD	PCB	6990	2700 - 6500	53	1967	50	4.7	2	1878
PL10A18L15C	60	2835 SMD	PCB	7985	2700 - 6500	53	2247	50	5.3	2	1878
PL10A19L15C	66	2835 SMD	PCB	8985	2700 - 6500	53	2527	50	5.9	2	1500
PL10A10L15C	75	2835 SMD	PCB	9985	2700 - 6500	53	2807	50	6.5	2	1500

Visible frame width / Largeur de cadre visible: 63mm

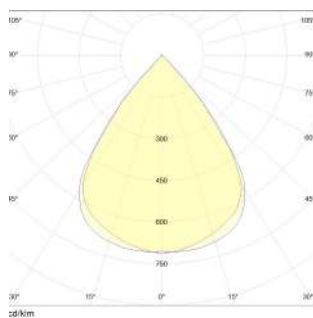
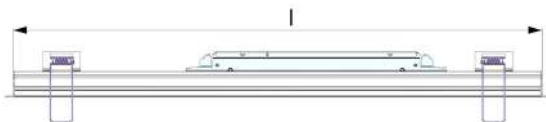
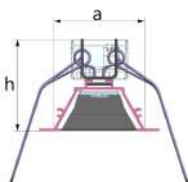

80° Light Beam

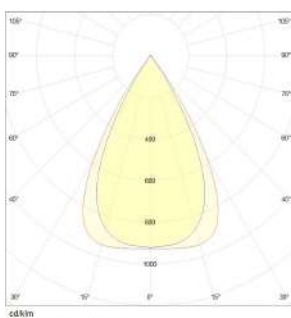

50° Light Beam



V / Hz | 220 - 240 / 50 - 60

Options	Options
Dimmable electronic ballast or convertor. Emergency kit	Ballast électronique dimmable ou converteur. Kit d'urgence.
NOTE	NOTE
Given lumen values are net delivered luminaire output lumens.	Les valeurs de lumens données sont les lumens de sortie nets du luminaire.
Given power values are total consumed AC power of the luminaire.	Les valeurs de puissance données sont la puissance AC totale consommée du luminaire.



# ELITE DAISY MIX

## LED

### Suspended Lighting Fixtures With Lens

### Luminaire Suspendus Avec Lentille

#### APPLICATION AREAS

Shopping Malls  
Supermarkets  
Offices  
Meeting rooms  
Stores  
Hospitals  
Schools  
Corridors

#### DOMAINES D'UTILISATION

Centres Commerciaux  
Supermarchés  
Bureaux  
Salles de Réunions  
Magasins  
Hopitaux  
Ecoles  
Couloirs

#### BODY

Anodized aluminum with satin finishing. Black and white color options with elegant design.

#### LENS

With 50° or 80° lens.

#### DIFFUSER

UV stabilized frosted diffuser.

#### CONVERTER

Compatible with ENEC standards.

#### LED

LED modules with 60.000 hours lifetime LUMILEDS / SAMSUNG / NICHIA brand LEDs.

#### SUSPENSION

Composed of 1mm steel wire rope and nickel-plated brass components. Suspension height is adjustable. Supplied with transparent electric cord and ceiling mounted electrical junction box with aesthetic design.

#### CORPS

Corps en aluminium anodisé, satiné. Design élégant. Couleurs blanc, noir disponibles.

#### LENS

Avec lentille 50° ou 80°.

#### DIFFUSEUR

Diffuseur givré. Anti UV.

#### CONVERTEUR

Convertisseur, conforme aux normes ENEC.

#### LED

Modules LED – Durée de vie 60.000 heures avec LED de marque LUMILEDS / SAMSUNG / NICHIA.

#### SYSTEME DE FIXATION

Composé d'un fil en acier de 1mm, de composants en laiton nickelés. Livré avec un cordon électrique transparent et une boîte de jonction électrique à fixer au plafond. Hauteur de fixation réglable.



Color Options  
Options de Couleur



LED Type / Type LED

Color Rendering Index / Indice de Rendu des Couleurs: (CRI): Ra>80

Code	Power Puissance (W)	LED Type Type De LED	LED Module Module LED	Lum. Flux Flux Lum. (lm)	Color Temperature Température De Couleur (K)	Dimensions (mm)			Weight Poids (kg)	Packing Quantity Colisage	Pcs./20" Container Pcs./20" Conteneur
						a	l	h			
PL10SM12L25C	37	2835 SMD	PCB	3430	2700 - 6500	47	1140	73	2.3	2	2835
PL10SM13L25C	46	2835 SMD	PCB	4145	2700 - 6500	47	1421	73	2.9	2	2295
PL10SM14L25C	57	2835 SMD	PCB	4860	2700 - 6500	47	1700	73	3.5	2	1970
PL10SM15L25C	67	2835 SMD	PCB	5575	2700 - 6500	47	1981	73	4.0	2	1560

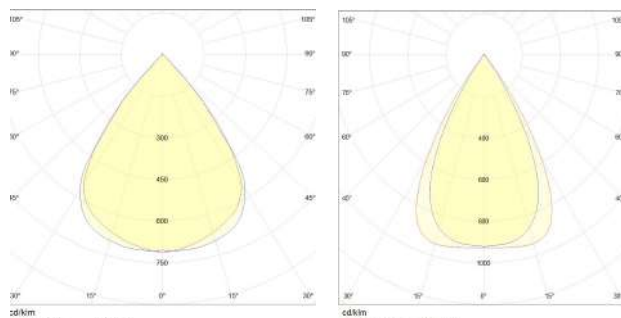
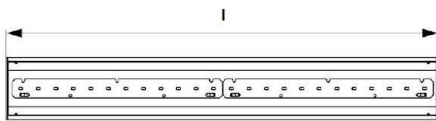
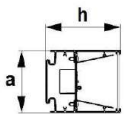

80° Light Beam

50° Light Beam

V / Hz 220 - 240 / 50 - 60

Options	Options
Dimmable electronic ballast or convertor. Emergency kit	Ballast électronique dimmable ou converteur. Kit d'urgence.
NOTE	NOTE
Given lumen values are net delivered luminaire output lumens.	Les valeurs de lumens données sont les lumens de sortie nets du luminaire.
Given power values are total consumed AC power of the luminaire.	Les valeurs de puissance données sont la puissance AC totale consommée du luminaire.

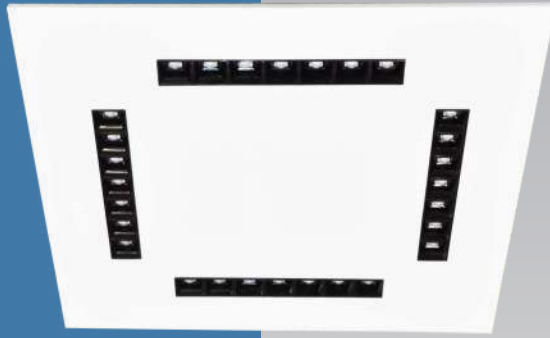

# ELITE DAISY SURFACE

## LED

### Surface Mounted Lighting Fixtures With Lens

### Luminaire Apparents Avec Lentille

#### APPLICATION AREAS

Offices  
Meeting rooms  
Stores  
Hospitals  
Schools  
Corridors

#### DOMAINES D'UTILISATION

Bureaux  
Salles de Réunion  
Magasins  
Hopitaux  
Ecoles  
Couloirs

#### BODY

Electrostatic powder coated sheetmetal.

#### LENS

With 50° or 80° lens.

#### REFLECTOR

Special reflector that provides homogeneous distribution together with the lenses.

#### CONVERTER

Long life, low power loss converter with constant current. Compatible with ENEC standards.

#### LED

LED modules with 60.000 hours lifetime LUMILEDS / SAMSUNG / NICHIA brand LEDs.

#### CORPS

Feuille de métal peinte électrostatiquement.

#### LENS

Avec lentille 50 ° ou 80 °.

#### RÉFLECTEUR

Réflecteur spécial qui assure une distribution homogène avec les lentilles.

#### CONVERTEUR

Convertisseur, conforme aux normes ENEC. Longue vie. Perte de puissance faible avec courant constant .

#### LED

Modules LED – Durée de vie 60.000 heures avec LED de marque LUMILEDS / SAMSUNG / NICHIA.

Color Options  
Options de Couleur



LED Type / Type LED

Color Rendering Index / Indice de Rendu des Couleurs: (CRI): Ra>80

Code	Power Puissance (W)	LED Type Type De LED	LED Module Module LED	Lum. Flux Flux Lum. (lm)	Color Temperature Température De Couleur (K)	Dimensions (mm)			Weight Poids (kg)	Packing Quantity Colisage	Pcs./20" Container Pcs./20" Conteneur
						a	b	h			
PL10U21E15C	16	2835 SMD	PCB	1845	2700 - 6500	300	300	25	2.5	4	1448
PL10U22E15C	29	2835 SMD	PCB	3690	2700 - 6500	300	1200	25	2.5	4	740
PL10U41E15C	29	2835 SMD	PCB	3690	2700 - 6500	600	600	25	2.5	4	740

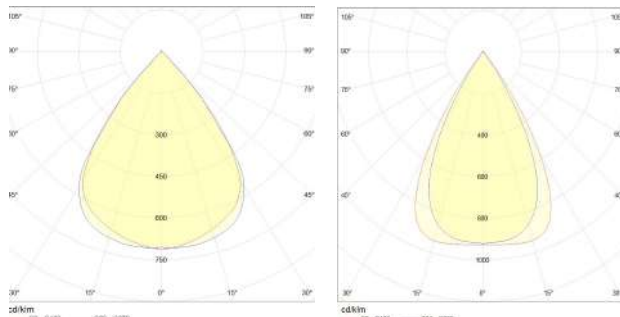

80° Light Beam

50° Light Beam

V / Hz 220 - 240 / 50 - 60

Options	Options
Dimmable electronic ballast or convertor.	Ballast électronique dimmable ou converteur.
Emergency kit	Kit d'urgence.

NOTE	NOTE
Given lumen values are net delivered luminaire output lumens.	Les valeurs de lumens données sont les lumens de sortie nets du luminaire.
Given power values are total consumed AC power of the luminaire.	Les valeurs de puissance données sont la puissance AC totale consommée du luminaire.

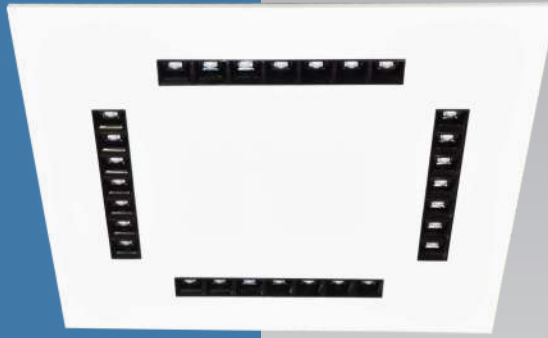

# ELITE DAISY RECESSED T BAR CEILING

## LED

### Recessed Lighting Fixtures With Lens

### Luminaire Encastrés Avec Lentille

#### APPLICATION AREAS

Offices  
Meeting rooms  
Stores  
Hospitals  
Schools  
Corridors

#### DOMAINES D'UTILISATION

Bureaux  
Salles de Réunion  
Magasins  
Hopitaux  
Ecoles  
Couloirs

#### BODY

Electrostatic powder coated sheetmetal.

#### LENS

With 50° or 80° lens.

#### REFLECTOR

Special reflector that provides homogeneous distribution together with the lenses.

#### CONVERTER

Long life, low power loss converter with constant current. Compatible with ENEC standards.

#### LED

LED modules with 60.000 hours lifetime LUMILEDS / SAMSUNG / NICHIA brand LEDs.

#### CORPS

Feuille de métal peinte électrostatiquement.

#### LENS

Avec lentille 50° ou 80°.

#### RÉFLECTEUR

Réflecteur spécial qui assure une distribution homogène avec les lentilles.

#### CONVERTEUR

Convertisseur, conforme aux normes ENEC. Longue vie. Perte de puissance faible avec courant constant.

#### LED

Modules LED – Durée de vie 60.000 heures avec LED de marque LUMILEDS / SAMSUNG / NICHIA.

Ceiling Mounting System  
Système de Montage au Plafond

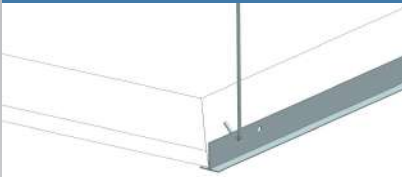

Color Options  
Options de Couleur



LED Type / Type LED

Color Rendering Index / Indice de Rendu des Couleurs: (CRI): Ra > 80

Code	Power Puissance (W)	LED Type Type De LED	LED Module Module LED	Lum. Flux Flux Lum. (lm)	Color Temperature Température De Couleur (K)	Dimensions (mm)					Weight Poids (kg)	Packing Quantity Colisage	Pcs./20" Container Pcs./20" Conteneur
						a1	a2	b1	b2	h			
PL10A21E15C	16	2835 SMD	PCB	1845	2700 - 6500	295	275	595	575	23	2.5	4	1448
PL10A22E15C	29	2835 SMD	PCB	3690	2700 - 6500	295	275	1195	1175	23	2.5	4	740
PL10A41E15C	29	2835 SMD	PCB	3690	2700 - 6500	595	575	595	575	23	2.5	4	740

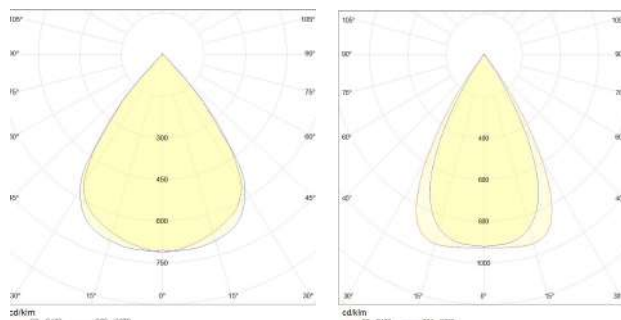
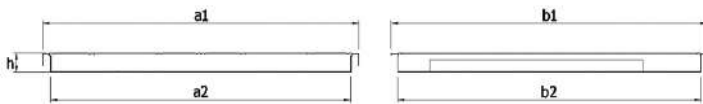

80° Light Beam

50° Light Beam

V / Hz 220 - 240 / 50 - 60

Options	Options
Dimmable electronic ballast or convertor.	Ballast électronique dimmable ou converteur.
Emergency kit	Kit d'urgence.
NOTE	NOTE
Given lumen values are net delivered luminaire output lumens.	Les valeurs de lumens données sont les lumens de sortie nets du luminaire.
Given power values are total consumed AC power of the luminaire.	Les valeurs de puissance données sont la puissance AC totale consommée du luminaire.



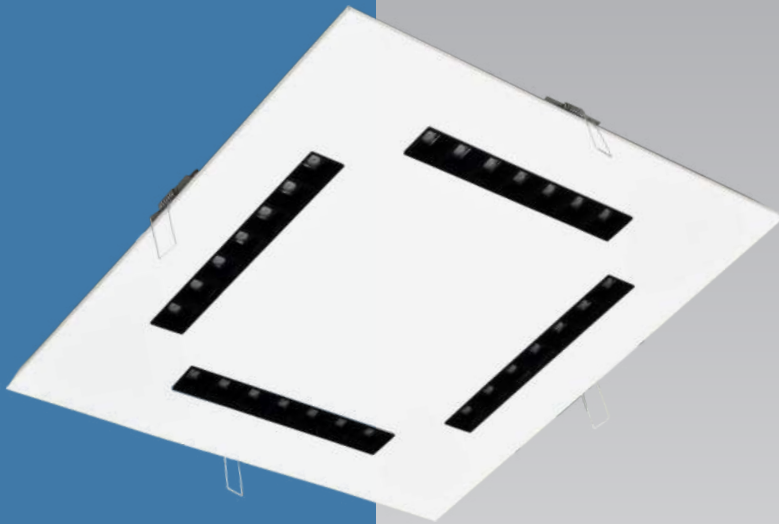

# ELITE DAISY RECESSED GYPSUM CEILING

## LED

### Recessed Lighting Fixtures With Lens

### Luminaire Encastrés Avec Lentille

#### APPLICATION AREAS

Offices  
Meeting rooms  
Stores  
Hospitals  
Schools  
Corridors

#### DOMAINES D'UTILISATION

Bureaux  
Salles de Réunion  
Magasins  
Hopitaux  
Ecoles  
Couloirs

#### BODY

Electrostatic powder coated sheetmetal.

#### LENS

With 50° or 80° lens.

#### REFLECTOR

Special reflector that provides homogeneous distribution together with the lenses.

#### CONVERTER

Long life, low power loss converter with constant current. Compatible with ENEC standards.

#### LED

LED modules with 60.000 hours lifetime LUMILEDS / SAMSUNG / NICHIA brand LEDs.

#### CORPS

Feuille de métal peinte électrostatiquement.

#### LENS

Avec lentille 50 ° ou 80 °.

#### RÉFLECTEUR

Réflecteur spécial qui assure une distribution homogène avec les lentilles.

#### CONVERTEUR

Convertisseur, conforme aux normes ENEC. Longue vie. Perte de puissance faible avec courant constant .

#### LED

Modules LED – Durée de vie 60.000 heures avec LED de marque LUMILEDS / SAMSUNG / NICHIA.

Ceiling Mounting System  
Système de Montage au Plafond

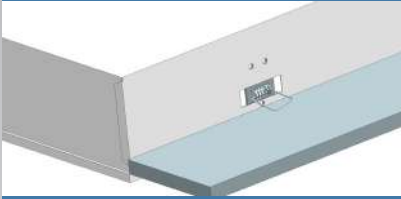

Color Options  
Options de Couleur



LED Type / Type LED

Color Rendering Index / Indice de Rendu des Couleurs: (CRI): Ra>80

Code	Power Puissance (W)	LED Type Type De LED	LED Module Module LED	Lum. Flux Flux Lum. (lm)	Color Temperature Température De Couleur (K)	Dimensions (mm)					Weight Poids (kg)	Packing Quantity Colisage	Pcs./20" Container Pcs./20" Conteneur
						a1	a2	b1	b2	h			
PL10AY21E15C	16	2835 SMD	PCB	1845	2700 - 6500	295	275	595	575	23	2.5	4	1448
PL10AY22E15C	29	2835 SMD	PCB	3690	2700 - 6500	295	275	1195	1175	23	2.5	4	740
PL10AY41E15C	29	2835 SMD	PCB	3690	2700 - 6500	595	575	595	575	23	2.5	4	740

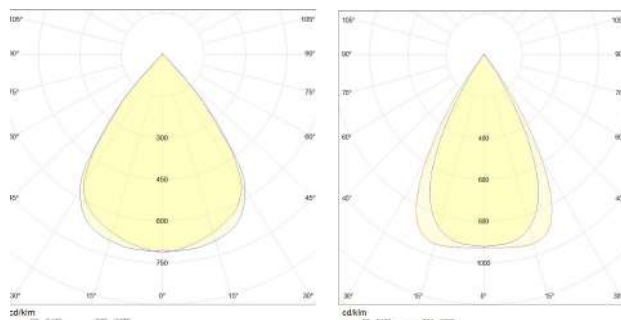
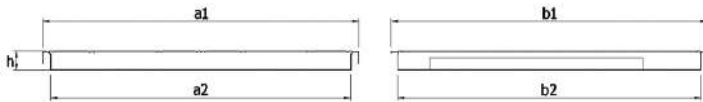

80° Light Beam

50° Light Beam

V / Hz 220 - 240 / 50 - 60

Options	Options
Dimmable electronic ballast or convertor.	Ballast électronique dimmable ou converteur.
Emergency kit	Kit d'urgence.

NOTE	NOTE
Given lumen values are net delivered luminaire output lumens.	Les valeurs de lumens données sont les lumens de sortie nets du luminaire.
Given power values are total consumed AC power of the luminaire.	Les valeurs de puissance données sont la puissance AC totale consommée du luminaire.





**PRIZMA**

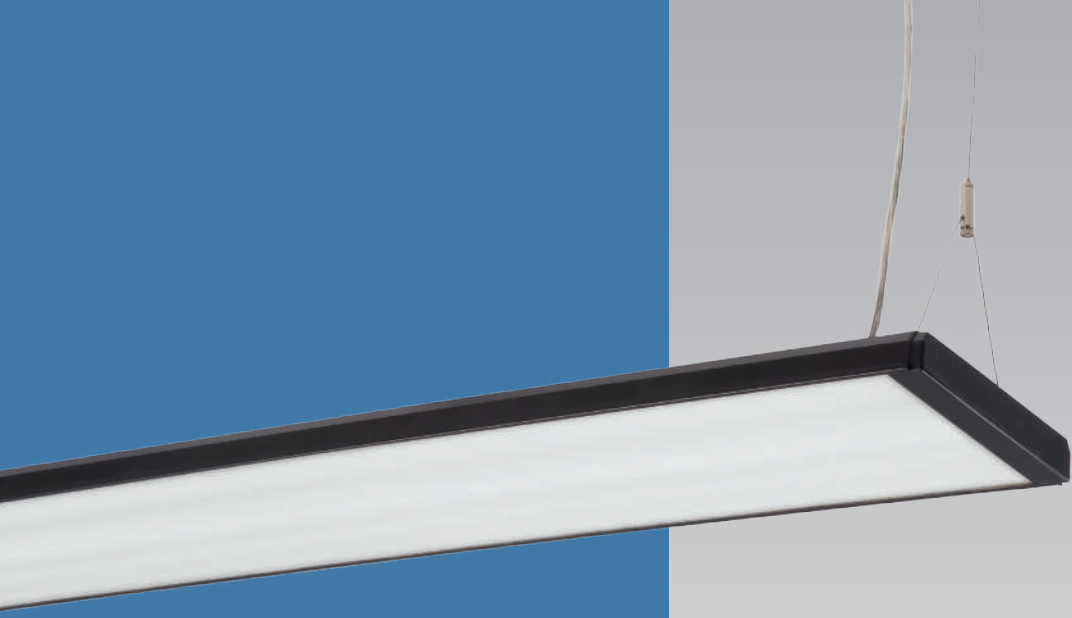

# PRIZMA

## LED

### Suspended 2X Lighting Fixtures With Frosted Diffuser

### Luminaire suspendu 2X Avec Diffuseur Givré

#### BODY

Anodized aluminum with satin finishing. Black, white and silver color options with thin (32mm) elegant design.

#### DIFFUSER

UV stabilized frosted diffuser.

#### CONVERTER

Long life, low power loss converter with constant current. Compatible with ENEC standards.

#### LED

LED modules with 60.000 hours lifetime LUMILEDS / SAMSUNG / NICHIA brand LEDs.

#### SUSPENSION

Composed of 1mm steel wire rope and nickel-plated brass components. Suspension height is adjustable. Supplied with transparent electric cord and ceiling mounted electrical junction box with aesthetic design.

#### CORPS

Corps en aluminium anodisé, satiné. Design élégant. Couleurs blanc, argent et noir disponibles. Epaisseur 32 mm.

#### DIFFUSEUR

Diffuseur givré. Anti UV.

#### CONVERTEUR

Convertisseur, conforme aux normes ENEC. Longue vie. Perte de puissance faible avec courant constant.

#### LED

Modules LED – Durée de vie 60.000 heures avec LED de marque LUMILEDS / SAMSUNG / NICHIA.

#### SYSTEME DE FIXATION

Composé d'un fil en acier de 1mm, de composants en laiton nickelés. Livré avec un cordon électrique transparent et une boîte de jonction électrique à fixer au plafond. Hauteur de fixation réglable.

#### APPLICATION AREAS

Offices  
Meeting rooms  
Stores  
Hospitals  
Schools  
Corridors

#### DOMAINES D'UTILISATION

Bureaux  
Salles de Réunion  
Magasins  
Hopitaux  
Ecoles  
Couloirs

Color Options  
Options de Couleur



LED Type / Type LED

Color Rendering Index / Indice de Rendu des Couleurs: (CRI): Ra>80

Code	Power Puissance (W)	LED Type Type De LED	LED Module Module LED	Lum. Flux Flux Lum. (lm)	Color Temperature Température De Couleur (K)	Dimensions (mm)			Weight Poids (kg)	Packing Quantity Colisage	Pcs./20" Container Pcs./20" Conteneur
						a	b	h			
PL4S22L15C	26	2835 SMD	PCB	2775	2700 - 6500	223	620	32	2.6	2	2630
PL4S23L15C	39	2835 SMD	PCB	4160	2700 - 6500	223	900	32	3.3	2	1860
PL4S24L15C	53	2835 SMD	PCB	5550	2700 - 6500	223	1180	32	4.0	2	1440
PL4S25L15C	66	2835 SMD	PCB	6935	2700 - 6500	223	1460	32	4.8	2	1170

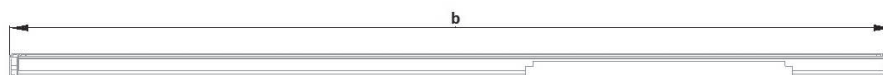
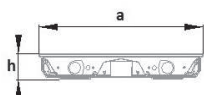

V / Hz 220 - 240 / 50 - 60

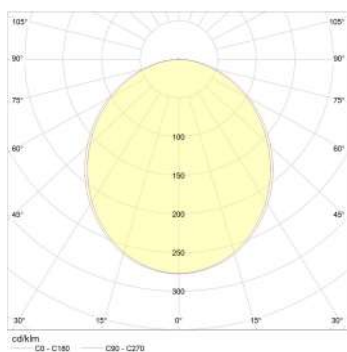

Options	Options
Dimmable electronic ballast or convertor. Emergency kit	Ballast électronique dimmable ou converteur. Kit d'urgence.
NOTE	NOTE
Given lumen values are net delivered luminaire output lumens.	Les valeurs de lumens données sont les lumens de sortie nets du luminaire.
Given power values are total consumed AC power of the luminaire.	Les valeurs de puissance données sont la puissance AC totale consommée du luminaire.



# PRIZMA

## LED

### Surface Mounted 2X Lighting Fixtures With Frosted Diffuser

### Luminaire Apparents 2X Avec Diffuseur Givré

#### BODY

Anodized aluminum with satin finishing. Black, white and silver color options with thin (32mm) elegant design.

#### DIFFUSER

UV stabilized frosted diffuser.

#### CONVERTER

Long life, low power loss converter with constant current. Compatible with ENEC standards.

#### LED

LED modules with 60.000 hours lifetime LUMILEDS / SAMSUNG / NICHIA brand LEDs.

#### CORPS

Corps en aluminium anodisé, satiné. Design élégant. Couleurs blanc, argent et noir disponibles. Epaisseur 32 mm.

#### DIFFUSEUR

Diffuseur givré. Anti UV.

#### CONVERTEUR

Convertisseur, conforme aux normes ENEC. Longue vie. Perte de puissance faible avec courant constant.

#### LED

Modules LED – Durée de vie 60.000 heures avec LED de marque LUMILEDS / SAMSUNG / NICHIA.

#### APPLICATION AREAS

Offices  
Meeting rooms  
Stores  
Hospitals  
Schools  
Corridors

#### DOMAINES D'UTILISATION

Bureaux  
Salles de Réunion  
Magasins  
Hopitaux  
Ecoles  
Couloirs

Color Options  
Options de Couleur



LED Type / Type LED

Color Rendering Index / Indice de Rendu des Couleurs: (CRI): Ra>80

Code	Power Puissance (W)	LED Type Type De LED	LED Module Module LED	Lum. Flux Flux Lum. (lm)	Color Temperature Température De Couleur (K)	Dimensions (mm)			Weight Poids (kg)	Packing Quantity Colisage	Pcs./20" Container Pcs./20" Conteneur
						a	b	h			
PL4U22L15C	26	2835 SMD	PCB	2775	2700 - 6500	223	620	32	2.6	2	2630
PL4U23L15C	39	2835 SMD	PCB	4160	2700 - 6500	223	900	32	3.3	2	1860
PL4U24L15C	53	2835 SMD	PCB	5550	2700 - 6500	223	1180	32	4.0	2	1440
PL4U25L15C	66	2835 SMD	PCB	6935	2700 - 6500	223	1460	32	4.8	2	1170

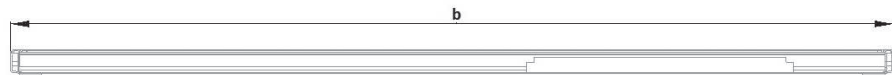
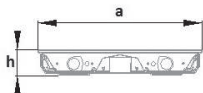

V / Hz 220 - 240 / 50 - 60

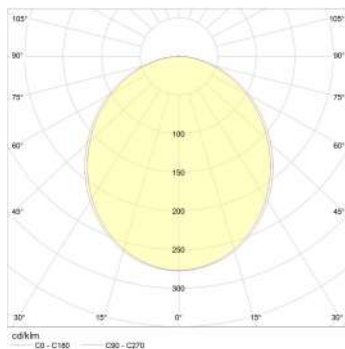

Options	Options
Dimmable electronic ballast or convertor. Emergency kit	Ballast électronique dimmable ou converteur. Kit d'urgence.
NOTE	NOTE
Given lumen values are net delivered luminaire output lumens.	Les valeurs de lumens données sont les lumens de sortie nets du luminaire.
Given power values are total consumed AC power of the luminaire.	Les valeurs de puissance données sont la puissance AC totale consommée du luminaire.





## PRIZMA

### LED

#### Surface Mounted 4X Lighting Fixtures With Frosted Diffuser

#### Luminaire Apparents 4X Avec Diffuseur Givré

##### BODY

Anodized aluminum with satin finishing. Black, white and silver color options with thin (32mm) elegant design.

##### DIFFUSER

UV stabilized frosted diffuser.

##### CONVERTER

Long life, low power loss converter with constant current. Compatible with ENEC standards.

##### LED

LED modules with 60.000 hours lifetime LUMILEDS / SAMSUNG / NICHIA brand LEDs.

##### CORPS

Corps en aluminium anodisé, satiné. Design élégant. Couleurs blanc, argent et noir disponibles. Epaisseur 32 mm.

##### DIFFUSEUR

Diffuseur givré. Anti UV.

##### CONVERTEUR

Convertisseur, conforme aux normes ENEC. Longue vie. Perte de puissance faible avec courant constant.

##### LED

Modules LED – Durée de vie 60.000 heures avec LED de marque LUMILEDS / SAMSUNG / NICHIA.

##### APPLICATION AREAS

Offices  
Meeting rooms  
Stores  
Hospitals  
Schools  
Corridors

##### DOMAINES D'UTILISATION

Bureaux  
Salles de Réunion  
Magasins  
Hopitaux  
Ecoles  
Couloirs

Color Options  
Options de Couleur



LED Type / Type LED

Color Rendering Index / Indice de Rendu des Couleurs: (CRI): Ra>80

Code	Power Puissance (W)	LED Type Type De LED	LED Module Module LED	Lum. Flux Flux Lum. (lm)	Color Temperature Température De Couleur (K)	Dimensions (mm)			Weight Poids (kg)	Packing Quantity Colisage	Pcs./20" Container Pcs./20" Conteneur
						a	b	h			
PL4U42L15C	53	2835 SMD	PCB	4560	2700 - 6500	389	620	32	3.2	2	1680
PL4U43L15C	79	2835 SMD	PCB	6840	2700 - 6500	389	900	32	4.5	2	1180
PL4U44L15C	105	2835 SMD	PCB	9120	2700 - 6500	389	1180	32	5.9	2	910
PL4U45L15C	132	2835 SMD	PCB	11400	2700 - 6500	389	1460	32	7.2	2	745

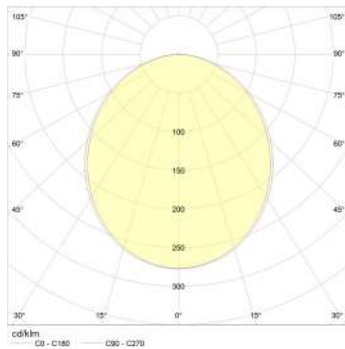
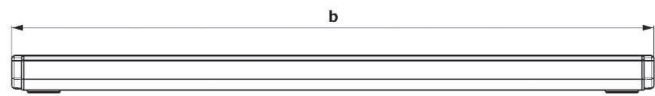
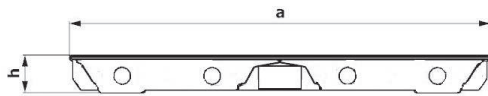

V / Hz 220 - 240 / 50 - 60

Options	Options
Dimmable electronic ballast or converter. Emergency kit	Ballast électronique dimmable ou converteur. Kit d'urgence.
NOTE	NOTE
Given lumen values are net delivered luminaire output lumens.	Les valeurs de lumens données sont les lumens de sortie nets du luminaire.
Given power values are total consumed AC power of the luminaire.	Les valeurs de puissance données sont la puissance AC totale consommée du luminaire.





**FAST LINE**



## FAST LINE

### LED

#### Suspended Lighting Fixtures With Frosted Diffuser

#### Luminaire suspendus Avec Diffuseur Givré

#### APPLICATION AREAS

Shopping Malls  
Supermarkets  
Offices  
Meeting rooms  
Stores  
Hospitals  
Schools  
Corridors

#### DOMAINES D'UTILISATION

Centres Commerciaux  
Supermarchés  
Bureaux  
Salles de Réunions  
Magasins  
Hopitaux  
Ecoles  
Couloirs

#### BODY

Anodized aluminum with satin finishing. Black and white color options with elegant design.

#### DIFFUSER

UV stabilized frosted diffuser.

#### CONVERTER

Long life, low power loss converter with constant current. Compatible with ENEC standards.

#### LED

LED modules with 60.000 hours lifetime LUMILEDS / SAMSUNG / NICHIA brand LEDs.

#### SUSPENSION

Composed of 1mm steel wire rope and nickel-plated brass components. Suspension height is adjustable. Supplied with transparent electric cord and ceiling mounted electrical junction box with aesthetic design

#### CORPS

Corps en aluminium anodisé, satiné. Design élégant. Couleurs blanc, noir disponibles.

#### DIFFUSEUR

Diffuseur givré. Anti UV.

#### CONVERTEUR

Convertisseur, conforme aux normes ENEC. Longue vie. Perte de puissance faible avec courant constant.

#### LED

Modules LED – Durée de vie 60.000 heures avec LED de marque LUMILEDS / SAMSUNG / NICHIA.

#### SYSTEME DE FIXATION

Composé d'un fil en acier de 1mm, de composants en laiton nickelés. Livré avec un cordon électrique transparent et une boîte de jonction électrique à fixer au plafond. Hauteur de fixation réglable.

Color Options  
Options de Couleur



LED Type / Type LED

Color Rendering Index / Indice de Rendu des Couleurs: (CRI): Ra>80

Code	Power Puissance (W)	LED Type Type De LED	LED Module Module LED	Lum. Flux Flux Lum. (lm)	Color Temperature Température De Couleur (K)	Dimensions (mm)			Weight Poids (kg)	Packing Quantity Colisage	Pcs./20" Container Pcs./20" Conteneur
						a	l	h			
PL23S12L15C	14	2835 SMD	PCB	1120	2700 - 6500	45	570	65	0.7	4	8000
PL23S12L25C	21	2835 SMD	PCB	1690	2700 - 6500	45	570	65	0.7	4	8000
PL23S13L15C	21	2835 SMD	PCB	1685	2700 - 6500	45	850	65	1.1	4	8000
PL23S13L25C	30	2835 SMD	PCB	2535	2700 - 6500	45	850	65	1.1	4	8000
PL23S14L15C	26	2835 SMD	PCB	2245	2700 - 6500	45	1130	65	1.4	4	5650
PL23S14L25C	41	2835 SMD	PCB	3375	2700 - 6500	45	1130	65	1.4	4	5650
PL23S15L15C	33	2835 SMD	PCB	2805	2700 - 6500	45	1412	65	1.8	4	4570
PL23S15L25C	51	2835 SMD	PCB	4220	2700 - 6500	45	1412	65	1.8	4	4570
PL23S16L15C	39	2835 SMD	PCB	3365	2700 - 6500	45	1693	65	2.1	4	4100
PL23S16L25C	61	2835 SMD	PCB	5065	2700 - 6500	45	1693	65	2.1	4	4100
PL23S17L15C	47	2835 SMD	PCB	3925	2700 - 6500	45	1973	65	2.5	4	3550
PL23S17L25C	70	2835 SMD	PCB	5905	2700 - 6500	45	1973	65	2.5	4	3550
PL23S18L15C	53	2835 SMD	PCB	4485	2700 - 6500	45	2254	65	2.8	4	3100
PL23S19L15C	60	2835 SMD	PCB	5045	2700 - 6500	45	2534	65	3.2	4	2650
PL23S10L15C	66	2835 SMD	PCB	5605	2700 - 6500	45	2815	65	3.5	4	2450

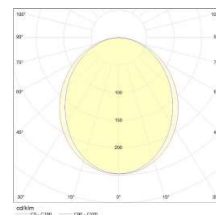
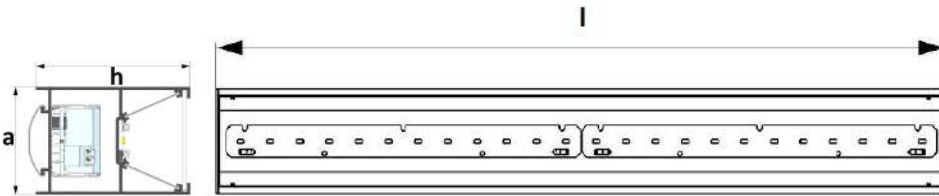

V / Hz 220 - 240 / 50 - 60

Options	Options
Dimmable electronic ballast or convertor. Emergency kit	Ballast électronique dimmable ou converteur. Kit d'urgence.

NOTE	NOTE
Given lumen values are net delivered luminaire output lumens.	Les valeurs de lumens données sont les lumens de sortie nets du luminaire.
Given power values are total consumed AC power of the luminaire.	Les valeurs de puissance données sont la puissance AC totale consommée du luminaire.



## FAST LINE

### LED

#### Surface Mounted Lighting Fixtures With Frosted Diffuser Luminaire Apparents Avec Diffuseur Givré

#### APPLICATION AREAS

Shopping Malls  
Supermarkets  
Offices  
Meeting rooms  
Stores  
Hospitals  
Schools  
Corridors

#### DOMAINES D'UTILISATION

Centres Commerciaux  
Supermarchés  
Bureaux  
Salles de Réunions  
Magasins  
Hopitaux  
Ecoles  
Couloirs

#### BODY

Anodized aluminum with satin finishing. Black and white color options with elegant design.

#### DIFFUSER

UV stabilized frosted diffuser.

#### CONVERTER

Long life, low power loss converter with constant current. Compatible with ENEC standards.

#### LED

LED modules with 60.000 hours lifetime LUMILEDS / SAMSUNG / NICHIA brand LEDs.

#### CORPS

Corps en aluminium anodisé, satiné. Design élégant. Couleurs blanc, noir disponibles.

#### DIFFUSEUR

Diffuseur givré. Anti UV.

#### CONVERTEUR

Convertisseur, conforme aux normes ENEC. Longue vie. Perte de puissance faible avec courant constant.

#### LED

Modules LED – Durée de vie 60.000 heures avec LED de marque LUMILEDS / SAMSUNG / NICHIA.

Color Options  
Options de Couleur



LED Type / Type LED

Color Rendering Index / Indice de Rendu des Couleurs: (CRI): Ra>80

Code	Power Puissance (W)	LED Type Type De LED	LED Module Module LED	Lum. Flux Flux Lum. (lm)	Color Temperature Température De Couleur (K)	Dimensions (mm)			Weight Poids (kg)	Packing Quantity Colisage	Pcs./20" Container Pcs./20" Conteneur
						a	l	h			
PL23U12L15C	14	2835 SMD	PCB	1120	2700 - 6500	45	570	65	0.7	4	8000
PL23U12L25C	21	2835 SMD	PCB	1690	2700 - 6500	45	570	65	0.7	4	8000
PL23U13L15C	21	2835 SMD	PCB	1685	2700 - 6500	45	850	65	1.1	4	8000
PL23U13L25C	30	2835 SMD	PCB	2535	2700 - 6500	45	850	65	1.1	4	8000
PL23U14L15C	26	2835 SMD	PCB	2245	2700 - 6500	45	1130	65	1.4	4	5650
PL23U14L25C	41	2835 SMD	PCB	3375	2700 - 6500	45	1130	65	1.4	4	5650
PL23U15L15C	33	2835 SMD	PCB	2805	2700 - 6500	45	1412	65	1.8	4	4570
PL23U15L25C	51	2835 SMD	PCB	4220	2700 - 6500	45	1412	65	1.8	4	4570
PL23U16L15C	39	2835 SMD	PCB	3365	2700 - 6500	45	1693	65	2.1	4	4100
PL23U16L25C	61	2835 SMD	PCB	5065	2700 - 6500	45	1693	65	2.1	4	4100
PL23U17L15C	47	2835 SMD	PCB	3925	2700 - 6500	45	1973	65	2.5	4	3550
PL23U17L25C	70	2835 SMD	PCB	5905	2700 - 6500	45	1973	65	2.5	4	3550
PL23U18L15C	53	2835 SMD	PCB	4485	2700 - 6500	45	2254	65	2.8	4	3100
PL23U19L15C	60	2835 SMD	PCB	5045	2700 - 6500	45	2534	65	3.2	4	2650
PL23U10L15C	66	2835 SMD	PCB	5605	2700 - 6500	45	2815	65	3.5	4	2450

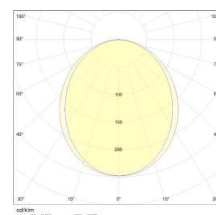
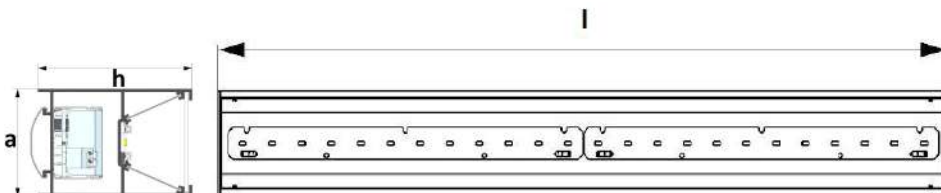

V / Hz 220 - 240 / 50 - 60

Options	Options
Dimmable electronic ballast or convertor. Emergency kit	Ballast électronique dimmable ou convertor. Kit d'urgence.

NOTE	NOTE
Given lumen values are net delivered luminaire output lumens.	Les valeurs de lumens données sont les lumens de sortie nets du luminaire.
Given power values are total consumed AC power of the luminaire.	Les valeurs de puissance données sont la puissance AC totale consommée du luminaire.







**VEGA**

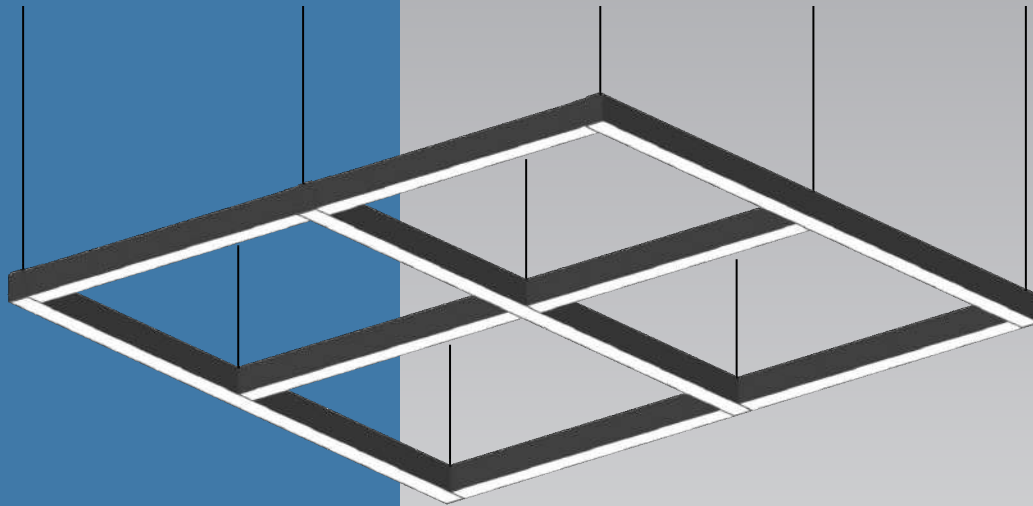

## VEGA GRID

### LED

#### Suspended Lighting Fixtures With Frosted Diffuser

#### Luminaire Suspendus Avec Diffuseur Givré

#### APPLICATION AREAS

Shopping Malls  
Supermarkets  
Offices  
Meeting rooms  
Stores  
Hospitals  
Schools  
Corridors

#### DOMAINES D'UTILISATION

Centres Commerciaux  
Supermarchés  
Bureaux  
Salles de Réunions  
Magasins  
Hopitaux  
Ecoles  
Couloirs

#### BODY

Anodized aluminum with satin finishing. Black and white color options with elegant design.

#### DIFFUSER

UV stabilized frosted diffuser.

#### CONVERTER

Long life, low power loss converter with constant current. Compatible with ENEC standards.

#### LED

LED modules with 60.000 hours lifetime LUMILEDS / SAMSUNG / NICHIA brand LEDs.

#### SUSPENSION

Composed of 1mm steel wire rope and nickel-plated brass components. Suspension height is adjustable. Supplied with transparent electric cord and ceiling mounted electrical junction box with aesthetic design

#### CORPS

Corps en aluminium anodisé, satiné. Design élégant. Couleurs blanc, noir disponibles.

#### DIFFUSEUR

Diffuseur givré. Anti UV.

#### CONVERTEUR

Convertisseur, conforme aux normes ENEC. Longue vie. Perte de puissance faible avec courant constant.

#### LED

Modules LED – Durée de vie 60.000 heures avec LED de marque LUMILEDS / SAMSUNG / NICHIA.

#### SYSTEME DE FIXATION

Composé d'un fil en acier de 1mm, de composants en laiton nickelés. Livré avec un cordon électrique transparent et une boîte de jonction électrique à fixer au plafond. Hauteur de fixation réglable.

Color Options  
Options de Couleur



LED Type / Type LED

Color Rendering Index / Indice de Rendu des Couleurs: (CRI): Ra>80

Code	Power Puissance (W)	LED Type Type De LED	LED Module Module LED	Lum. Flux Flux Lum. (lm)	Color Temperature Température De Couleur (K)	Dimensions (mm)			Weight Poids (kg)	Packing Quantity Colisage	Pcs./20" Container Pcs./20" Conteneur
						a	l	h			
PL7SI12L15CS	14	2835 SMD	PCB	1295	2700 - 6500	70	570	90	1.9	4	2910
PL7SI12L25CS	21	2835 SMD	PCB	1945	2700 - 6500	70	570	90	2.0	4	2910
PL7SI13L15CS	21	2835 SMD	PCB	1940	2700 - 6500	70	850	90	2.5	4	2910
PL7SI13L25CS	30	2835 SMD	PCB	2920	2700 - 6500	70	850	90	2.6	4	2910
PL7SI14L15CS	26	2835 SMD	PCB	2585	2700 - 6500	70	1130	90	3.1	4	2270
PL7SI14L25CS	41	2835 SMD	PCB	3890	2700 - 6500	70	1130	90	3.2	4	2270
PL7SI15L15CS	33	2835 SMD	PCB	3230	2700 - 6500	70	1412	90	3.7	4	1840
PL7SI15L25CS	51	2835 SMD	PCB	4865	2700 - 6500	70	1412	90	3.8	4	1840
PL7SI16L15CS	39	2835 SMD	PCB	3880	2700 - 6500	70	1693	90	4.3	4	1575
PL7SI16L25CS	61	2835 SMD	PCB	5835	2700 - 6500	70	1693	90	4.4	4	1575
PL7SI17L15CS	47	2835 SMD	PCB	4525	2700 - 6500	70	1973	90	4.9	4	1250
PL7SI17L25CS	70	2835 SMD	PCB	6810	2700 - 6500	70	1973	90	5.1	4	1250
PL7SI18L15CS	53	2835 SMD	PCB	5170	2700 - 6500	70	2254	90	5.5	4	1250
PL7SI19L15CS	60	2835 SMD	PCB	5815	2700 - 6500	70	2534	90	6.1	4	1250
PL7SI10L15CS	66	2835 SMD	PCB	6460	2700 - 6500	70	2815	90	6.7	4	1000

V / Hz 220 - 240 / 50 - 60

Options	Options
Dimmable electronic ballast or convertor.	Ballast électronique dimmable ou converteur.
Emergency kit	Kit d'urgence.

NOTE	NOTE
Given lumen values are net delivered luminaire output lumens.	Les valeurs de lumens données sont les lumens de sortie nets du luminaire.
Given power values are total consumed AC power of the luminaire.	Les valeurs de puissance données sont la puissance AC totale consommée du luminaire.

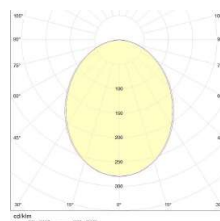
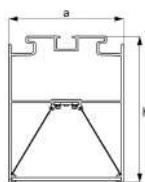
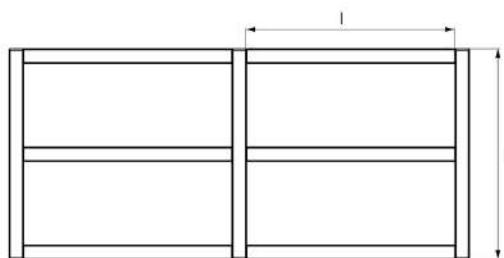



# KARE VEGA

## LED

### Suspended Lighting Fixtures With Frosted Diffuser

### Luminaire Suspendus Avec Diffuseur Givré

#### APPLICATION AREAS

Shopping Malls  
Supermarkets  
Offices  
Meeting rooms  
Stores  
Hospitals  
Schools  
Corridors

#### DOMAINES D'UTILISATION

Centres Commerciaux  
Supermarchés  
Bureaux  
Salles de Réunions  
Magasins  
Hopitaux  
Ecoles  
Couloirs

#### BODY

Anodized aluminum with satin finishing. Black and white color options with elegant design.

#### DIFFUSER

UV stabilized frosted diffuser.

#### CONVERTER

Long life, low power loss converter with constant current. Compatible with ENEC standards.

#### LED

LED modules with 60.000 hours lifetime LUMILEDS / SAMSUNG / NICHIA brand LEDs.

#### SUSPENSION

Composed of 1mm steel wire rope and nickel-plated brass components. Suspension height is adjustable. Supplied with transparent electric cord and ceiling mounted electrical junction box with aesthetic design

#### CORPS

Corps en aluminium anodisé, satiné. Design élégant. Couleurs blanc, noir disponibles.

#### DIFFUSEUR

Diffuseur givré. Anti UV.

#### CONVERTEUR

Convertisseur, conforme aux normes ENEC. Longue vie. Perte de puissance faible avec courant constant.

#### LED

Modules LED – Durée de vie 60.000 heures avec LED de marque LUMILEDS / SAMSUNG / NICHIA.

#### SYSTEME DE FIXATION

Composé d'un fil en acier de 1mm, de composants en laiton nickelés. Livré avec un cordon électrique transparent et une boîte de jonction électrique à fixer au plafond. Hauteur de fixation réglable.

Color Options  
Options de Couleur



LED Type / Type LED

Color Rendering Index / Indice de Rendu des Couleurs: (CRI): Ra>80

Code	Power Puissance (W)	LED Type Type De LED	LED Module Module LED	Lum. Flux Flux Lum. (lm)	Color Temperature Température De Couleur (K)	Dimensions (mm)			Weight Poids (kg)	Packing Quantity Colisage	Pcs./20" Container Pcs./20" Conteneur
						a	b	h			
PL7SK22L15C	53	2835 SMD	PCB	4790	2700 - 6500	640	640	90	5.5	1	415
PL7SK33L15C	79	2835 SMD	PCB	7185	2700 - 6500	921	921	90	8.1	1	210
PL7SK44L15C	105	2835 SMD	PCB	9580	2700 - 6500	1201	1201	90	10.2	1	125
PL7SK55L15C	132	2835 SMD	PCB	11970	2700 - 6500	1482	1482	90	13.3	1	85
PL7SK66L15C	158	2835 SMD	PCB	14365	2700 - 6500	1763	1763	90	15.6	1	60
PL7SK88L15C	205	2835 SMD	PCB	19155	2700 - 6500	2325	2325	90	17.9	1	35
PL7SK23L15C	66	2835 SMD	PCB	5985	2700 - 6500	640	921	90	6.8	1	295
PL7SK24L15C	79	2835 SMD	PCB	7185	2700 - 6500	640	1201	90	7.9	1	230
PL7SK34L15C	92	2835 SMD	PCB	8380	2700 - 6500	921	1201	90	9.2	1	160
PL7SK35L15C	105	2835 SMD	PCB	9580	2700 - 6500	921	1482	90	10.2	1	130

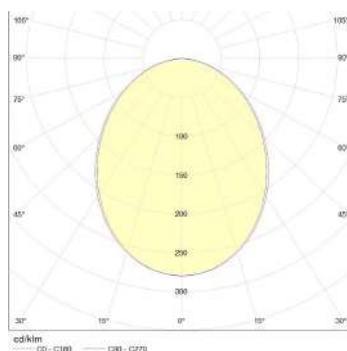
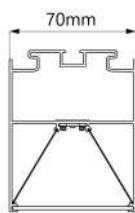
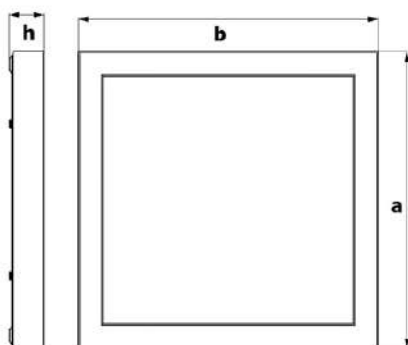

V / Hz 220 - 240 / 50 - 60

Options	Options
Dimmable electronic ballast or convertor. Emergency kit	Ballast électronique dimmable ou convertor. Kit d'urgence.
NOTE	NOTE
Given lumen values are net delivered luminaire output lumens.	Les valeurs de lumens données sont les lumens de sortie nets du luminaire.
Given power values are total consumed AC power of the luminaire.	Les valeurs de puissance données sont la puissance AC totale consommée du luminaire.

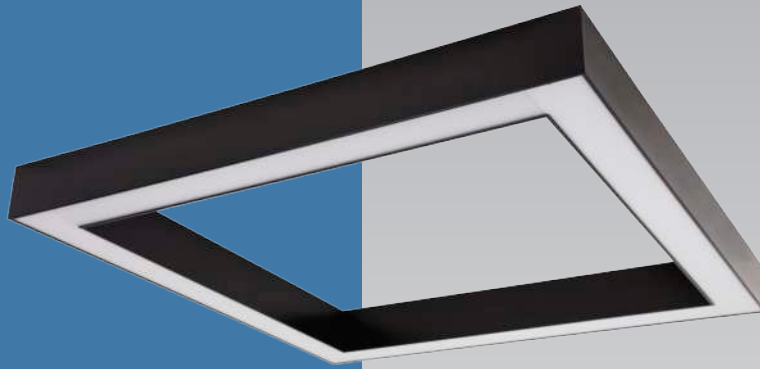

# KARE VEGA

## LED

Surface Mounted Lighting Fixtures With Frosted Diffuser

Luminaire Apparents Avec Diffuseur Givré

### APPLICATION AREAS

Shopping Malls  
Supermarkets  
Offices  
Meeting rooms  
Stores  
Hospitals  
Schools  
Corridors

### DOMAINES D'UTILISATION

Centres Commerciaux  
Supermarchés  
Bureaux  
Salles de Réunions  
Magasins  
Hopitaux  
Ecoles  
Couloirs

#### BODY

Anodized aluminum with satin finishing. Black and white color options with elegant design.

#### DIFFUSER

UV stabilized frosted diffuser.

#### CONVERTER

Long life, low power loss converter with constant current. Compatible with ENEC standards.

#### LED

LED modules with 60.000 hours lifetime LUMILEDS / SAMSUNG / NICHIA brand LEDs.

#### CORPS

Corps en aluminium anodisé, satiné. Design élégant. Couleurs blanc, noir disponibles.

#### DIFFUSEUR

Diffuseur givré. Anti UV.

#### CONVERTEUR

Convertisseur, conforme aux normes ENEC. Longue vie. Perte de puissance faible avec courant constant.

#### LED

Modules LED – Durée de vie 60.000 heures avec LED de marque LUMILEDS / SAMSUNG / NICHIA.

Color Options  
Options de Couleur



LED Type / Type LED

Color Rendering Index / Indice de Rendu des Couleurs: (CRI): Ra > 80

Code	Power Puissance (W)	LED Type Type De LED	LED Module Module LED	Lum. Flux Flux Lum. (lm)	Color Temperature Température De Couleur (K)	Dimensions (mm)			Weight Poids (kg)	Packing Quantity Colisage	Pcs./20" Container Pcs./20" Conteneur
						a	b	h			
PL7UK22L15C	53	2835 SMD	PCB	4790	2700 - 6500	640	640	90	5.5	1	415
PL7UK33L15C	79	2835 SMD	PCB	7185	2700 - 6500	921	921	90	8.1	1	210
PL7UK44L15C	105	2835 SMD	PCB	9580	2700 - 6500	1201	1201	90	10.2	1	125
PL7UK55L15C	132	2835 SMD	PCB	11970	2700 - 6500	1482	1482	90	13.3	1	85
PL7UK66L15C	158	2835 SMD	PCB	14365	2700 - 6500	1763	1763	90	15.6	1	60
PL7UK88L15C	205	2835 SMD	PCB	19155	2700 - 6500	2325	2325	90	17.9	1	35
PL7UK23L15C	66	2835 SMD	PCB	5985	2700 - 6500	640	921	90	6.8	1	295
PL7UK24L15C	79	2835 SMD	PCB	7185	2700 - 6500	640	1201	90	7.9	1	230
PL7UK34L15C	92	2835 SMD	PCB	8380	2700 - 6500	921	1201	90	9.2	1	160
PL7UK35L15C	105	2835 SMD	PCB	9580	2700 - 6500	921	1482	90	10.2	1	130

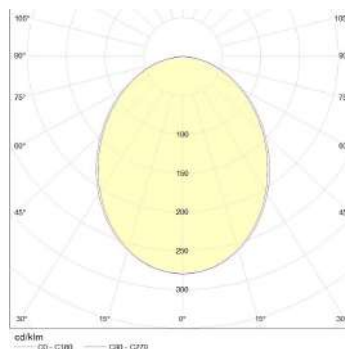
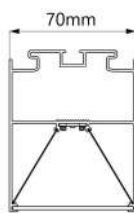
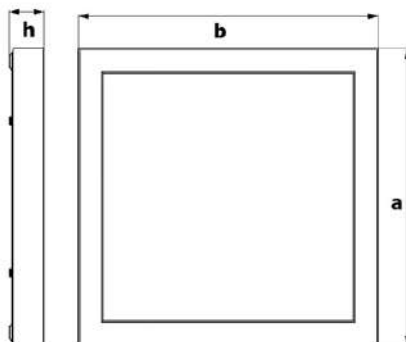

V / Hz 220 - 240 / 50 - 60

Options	Options
Dimmable electronic ballast or convertor. Emergency kit	Ballast électronique dimmable ou convertor. Kit d'urgence.
NOTE	NOTE
Given lumen values are net delivered luminaire output lumens.	Les valeurs de lumens données sont les lumens de sortie nets du luminaire.
Given power values are total consumed AC power of the luminaire.	Les valeurs de puissance données sont la puissance AC totale consommée du luminaire.



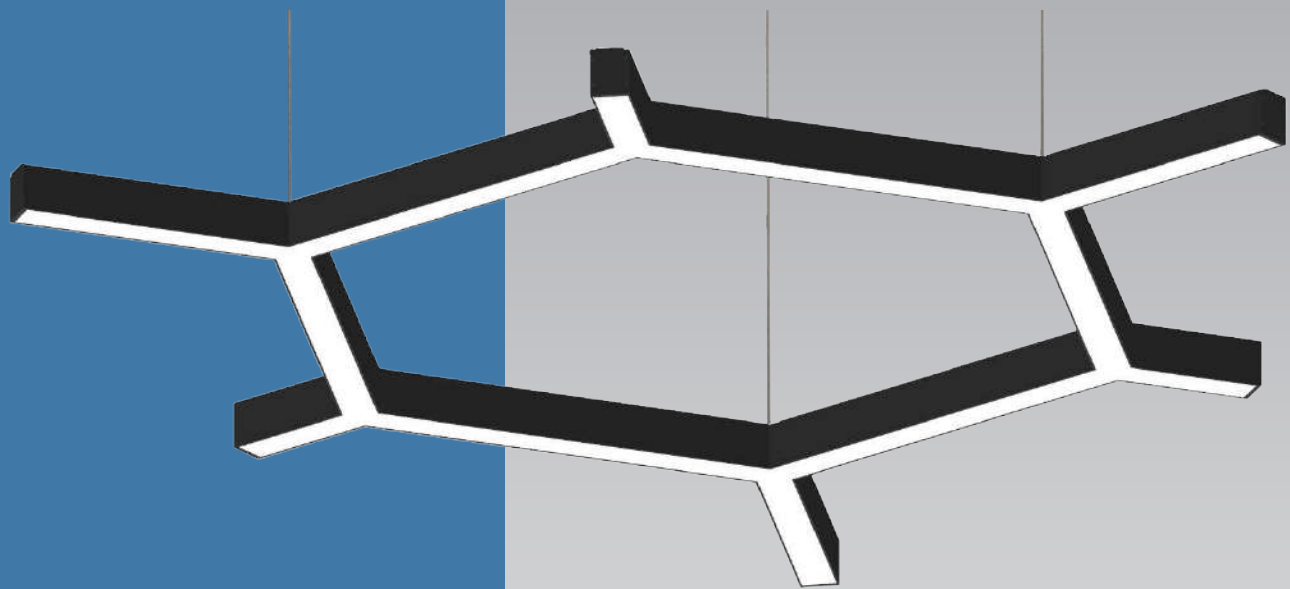

## VEGA LOUNGE

### LED

#### Suspended Lighting Fixtures With Frosted Diffuser

#### Luminaire Suspendus Avec Diffuseur Givré

#### APPLICATION AREAS

Shopping Malls  
Supermarkets  
Offices  
Meeting rooms  
Stores  
Hospitals  
Schools  
Corridors

#### DOMAINES D'UTILISATION

Centres Commerciaux  
Supermarchés  
Bureaux  
Salles de Réunions  
Magasins  
Hopitaux  
Ecoles  
Couloirs

#### BODY

Anodized aluminum with satin finishing. Black and white color options with elegant design.

#### DIFFUSER

UV stabilized frosted diffuser.

#### CONVERTER

Long life, low power loss converter with constant current. Compatible with ENEC standards.

#### LED

LED modules with 60.000 hours lifetime LUMILEDS / SAMSUNG / NICHIA brand LEDs.

#### SUSPENSION

Composed of 1mm steel wire rope and nickel-plated brass components. Suspension height is adjustable. Supplied with transparent electric cord and ceiling mounted electrical junction box with aesthetic design

#### CORPS

Corps en aluminium anodisé, satiné. Design élégant. Couleurs blanc, noir disponibles.

#### DIFFUSEUR

Diffuseur givré. Anti UV.

#### CONVERTEUR

Convertisseur, conforme aux normes ENEC. Longue vie. Perte de puissance faible avec courant constant.

#### LED

Modules LED – Durée de vie 60.000 heures avec LED de marque LUMILEDS / SAMSUNG / NICHIA.

#### SYSTEME DE FIXATION

Composé d'un fil en acier de 1mm, de composants en laiton nickelés. Livré avec un cordon électrique transparent et une boîte de jonction électrique à fixer au plafond. Hauteur de fixation réglable.

Color Options  
Options de Couleur



LED Type / Type LED

Color Rendering Index / Indice de Rendu des Couleurs: (CRI): Ra>80

Code	Power Puissance (W)	LED Type Type De LED	LED Module Module LED	Lum. Flux Flux Lum. (lm)	Color Temperature Température De Couleur (K)	Dimensions (mm)				Weight Poids (kg)	Packing Quantity Colisage	Pcs./20" Container Pcs./20" Conteneur
						a	l	h	w			
PL7SYL33L15CS	39	2835 SMD	PCB	3880	2700 - 6500	70	525	90	1065	4.1	1	304
PL7SYL63L15CS	60	2835 SMD	PCB	5815	2700 - 6500	70	806	90	1550	6.1	1	143
PL7SYL66L15CS	79	2835 SMD	PCB	7755	2700 - 6500	70	1086	90	2036	8.1	1	83

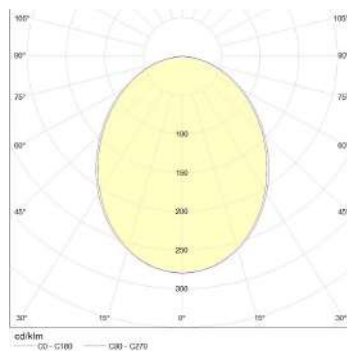
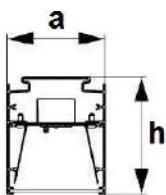
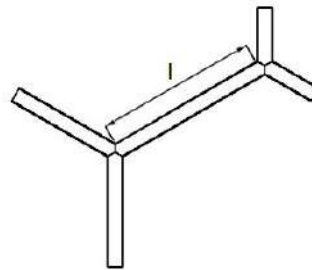
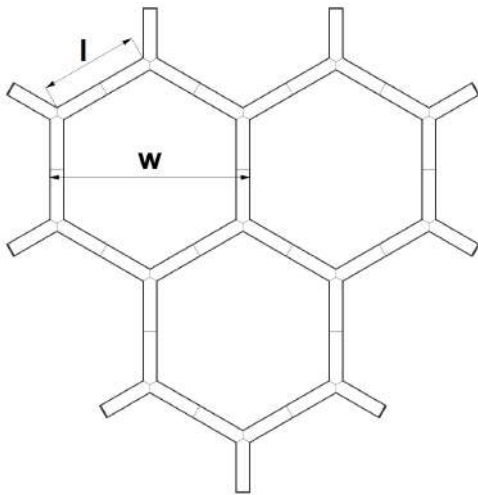

V / Hz 220 - 240 / 50 - 60

Options	Options
Dimmable electronic ballast or convertor. Emergency kit	Ballast électronique dimmable ou converteur. Kit d'urgence.
NOTE	NOTE
Given lumen values are net delivered luminaire output lumens.	Les valeurs de lumens données sont les lumens de sortie nets du luminaire.
Given power values are total consumed AC power of the luminaire.	Les valeurs de puissance données sont la puissance AC totale consommée du luminaire.

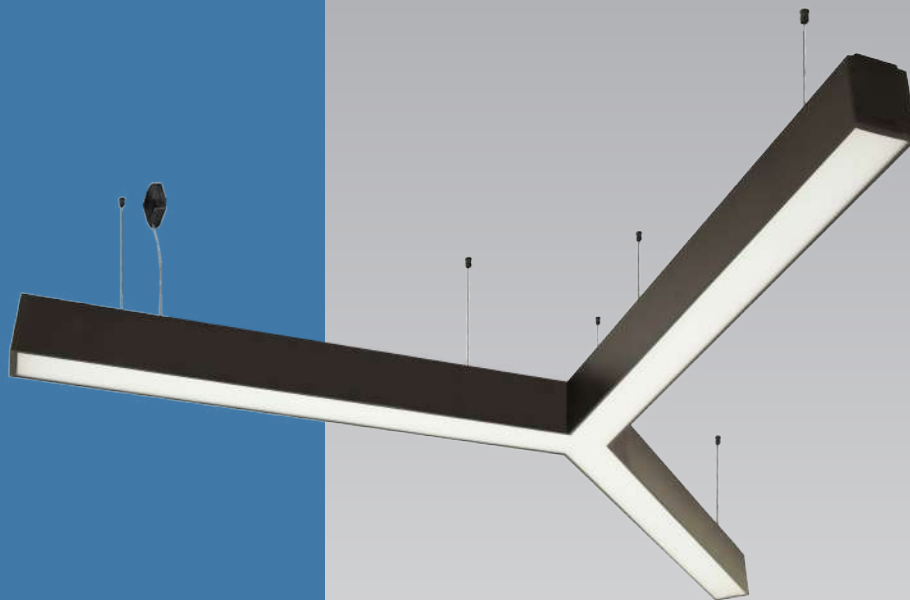

VEGA Y

## LED

### Suspended Lighting Fixtures With Frosted Diffuser

### Luminaire Suspendus Avec Diffuseur Givré

#### APPLICATION AREAS

Shopping Malls  
Supermarkets  
Offices  
Meeting rooms  
Stores  
Hospitals  
Schools  
Corridors

#### DOMAINES D'UTILISATION

Centres Commerciaux  
Supermarchés  
Bureaux  
Salles de Réunions  
Magasins  
Hopitaux  
Ecoles  
Couloirs

#### BODY

Anodized aluminum with satin finishing. Black and white color options with elegant design.

#### DIFFUSER

UV stabilized frosted diffuser.

#### CONVERTER

Long life, low power loss converter with constant current. Compatible with ENEC standards.

#### LED

LED modules with 60.000 hours lifetime LUMILEDS / SAMSUNG / NICHIA brand LEDs.

#### SUSPENSION

Composed of 1mm steel wire rope and nickel-plated brass components. Suspension height is adjustable. Supplied with transparent electric cord and ceiling mounted electrical junction box with aesthetic design

#### CORPS

Corps en aluminium anodisé, satiné. Design élégant. Couleurs blanc, noir disponibles.

#### DIFFUSEUR

Diffuseur givré. Anti UV.

#### CONVERTEUR

Convertisseur, conforme aux normes ENEC. Longue vie. Perte de puissance faible avec courant constant.

#### LED

Modules LED – Durée de vie 60.000 heures avec LED de marque LUMILEDS / SAMSUNG / NICHIA.

#### SYSTEME DE FIXATION

Composé d'un fil en acier de 1mm, de composants en laiton nickelés. Livré avec un cordon électrique transparent et une boîte de jonction électrique à fixer au plafond. Hauteur de fixation réglable.

Color Options  
Options de Couleur



LED Type / Type LED

Color Rendering Index / Indice de Rendu des Couleurs: (CRI): Ra>80

Code	Power Puissance (W)	LED Type Type De LED	LED Module Module LED	Lum. Flux Flux Lum. (lm)	Color Temperature Température De Couleur (K)	Dimensions (mm)			Weight Poids (kg)	Packing Quantity Colisage	Pcs./20" Container Pcs./20" Conteneur
						a	b	h			
PL7SY22L15C	39	2835 SMD	PCB	3880	2700 - 6500	870	994	90	4.3	1	205
PL7SY33L15C	60	2835 SMD	PCB	5815	2700 - 6500	1267	1472	90	6.1	1	95
PL7SY44L15C	79	2835 SMD	PCB	7755	2700 - 6500	1663	1951	90	8.2	1	55
PL7SY55L15C	99	2835 SMD	PCB	9690	2700 - 6500	2060	2430	90	10.5	1	35

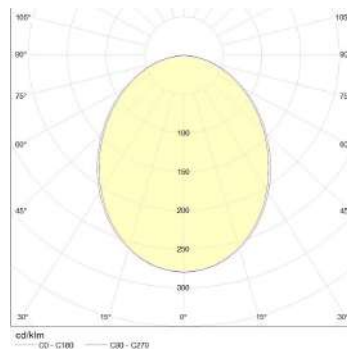
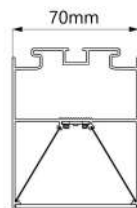
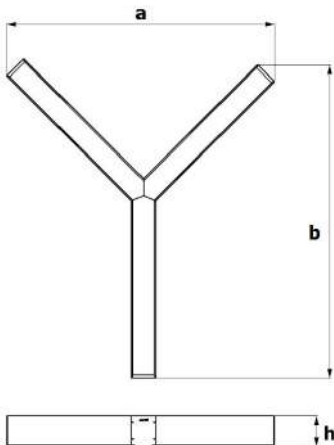

V / Hz 220 - 240 / 50 - 60

Options	Options
Dimmable electronic ballast or convertor. Emergency kit	Ballast électronique dimmable ou converteur. Kit d'urgence.
NOTE	NOTE
Given lumen values are net delivered luminaire output lumens.	Les valeurs de lumens données sont les lumens de sortie nets du luminaire.
Given power values are total consumed AC power of the luminaire.	Les valeurs de puissance données sont la puissance AC totale consommée du luminaire.

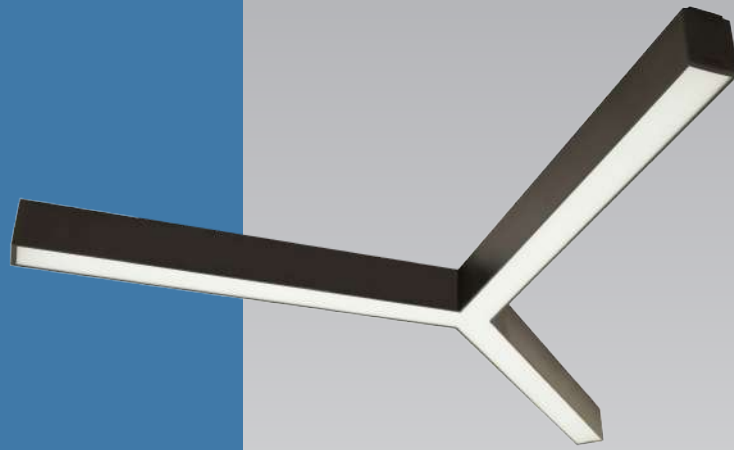

## VEGA Y

### LED

#### Surface Mounted Lighting Fixtures With Frosted Diffuser Luminaire Apparents Avec Diffuseur Givré

#### APPLICATION AREAS

Shopping Malls  
Supermarkets  
Offices  
Meeting rooms  
Stores  
Hospitals  
Schools  
Corridors

#### DOMAINES D'UTILISATION

Centres Commerciaux  
Supermarchés  
Bureaux  
Salles de Réunions  
Magasins  
Hopitaux  
Ecoles  
Couloirs

#### BODY

Anodized aluminum with satin finishing. Black and white color options with elegant design.

#### DIFFUSER

UV stabilized frosted diffuser.

#### CONVERTER

Long life, low power loss converter with constant current. Compatible with ENEC standards.

#### LED

LED modules with 60.000 hours lifetime LUMILEDS / SAMSUNG / NICHIA brand LEDs.

#### CORPS

Corps en aluminium anodisé, satiné. Design élégant. Couleurs blanc, noir disponibles.

#### DIFFUSEUR

Diffuseur givré. Anti UV.

#### CONVERTEUR

Convertisseur, conforme aux normes ENEC. Longue vie. Perte de puissance faible avec courant constant.

#### LED

Modules LED – Durée de vie 60.000 heures avec LED de marque LUMILEDS / SAMSUNG / NICHIA.

Color Options  
Options de Couleur



LED Type / Type LED

Color Rendering Index / Indice de Rendu des Couleurs: (CRI): Ra>80

Code	Power Puissance (W)	LED Type Type De LED	LED Module Module LED	Lum. Flux Flux Lum. (lm)	Color Temperature Température De Couleur (K)	Dimensions (mm)			Weight Poids (kg)	Packing Quantity Colisage	Pcs./20" Container Pcs./20" Conteneur
						a	b	h			
PL7UY22L15C	39	2835 SMD	PCB	3880	2700 - 6500	870	994	90	4.3	1	205
PL7UY33L15C	60	2835 SMD	PCB	5815	2700 - 6500	1267	1472	90	6.1	1	95
PL7UY44L15C	79	2835 SMD	PCB	7755	2700 - 6500	1663	1951	90	8.2	1	55
PL7UY55L15C	99	2835 SMD	PCB	9690	2700 - 6500	2060	2430	90	10.5	1	35

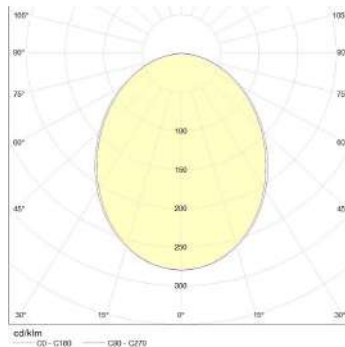
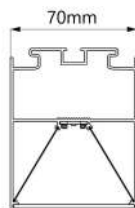
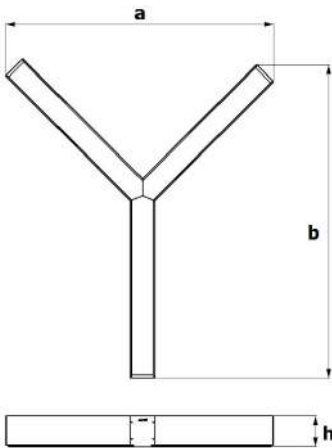

V / Hz 220 - 240 / 50 - 60

Options	Options
Dimmable electronic ballast or convertor. Emergency kit	Ballast électronique dimmable ou converteur. Kit d'urgence.
NOTE	NOTE
Given lumen values are net delivered luminaire output lumens.	Les valeurs de lumens données sont les lumens de sortie nets du luminaire.
Given power values are total consumed AC power of the luminaire.	Les valeurs de puissance données sont la puissance AC totale consommée du luminaire.

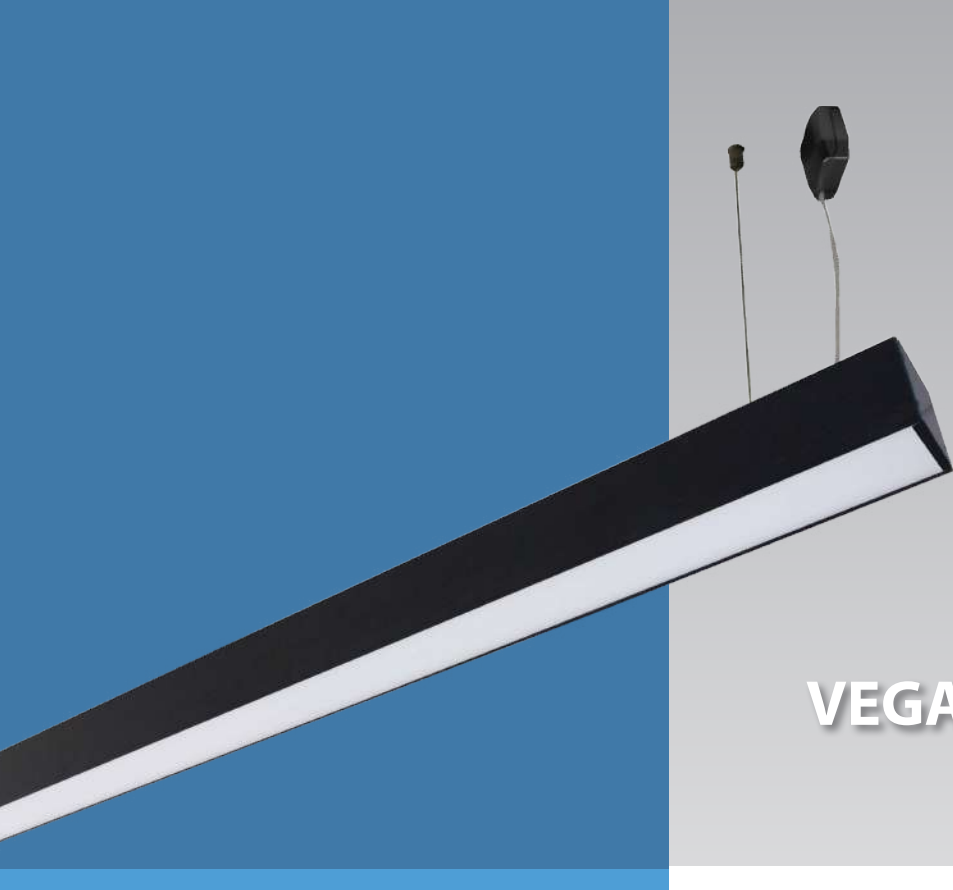

VEGA

## LED

### Suspended Lighting Fixtures With Frosted Diffuser

### Luminaire suspendu Avec Diffuseur Givré

#### APPLICATION AREAS

Shopping Malls  
Supermarkets  
Offices  
Meeting rooms  
Stores  
Hospitals  
Schools  
Corridors

#### DOMAINES D'UTILISATION

Centres Commerciaux  
Supermarchés  
Bureaux  
Salles de Réunions  
Magasins  
Hopitaux  
Ecoles  
Couloirs

#### BODY

Anodized aluminum with satin finishing. Black and white color options with elegant design.

#### DIFFUSER

UV stabilized frosted diffuser.

#### CONVERTER

Long life, low power loss converter with constant current. Compatible with ENEC standards.

#### LED

LED modules with 60.000 hours lifetime LUMILEDS / SAMSUNG / NICHIA brand LEDs.

#### SUSPENSION

Composed of 1mm steel wire rope and nickel-plated brass components. Suspension height is adjustable. Supplied with transparent electric cord and ceiling mounted electrical junction box with aesthetic design

#### CORPS

Corps en aluminium anodisé, satiné. Design élégant. Couleurs blanc, noir disponibles.

#### DIFFUSEUR

Diffuseur givré. Anti UV.

#### CONVERTEUR

Convertisseur, conforme aux normes ENEC. Longue vie. Perte de puissance faible avec courant constant.

#### LED

Modules LED – Durée de vie 60.000 heures avec LED de marque LUMILEDS / SAMSUNG / NICHIA.

#### SYSTEME DE FIXATION

Composé d'un fil en acier de 1mm, de composants en laiton nickelés. Livré avec un cordon électrique transparent et une boîte de jonction électrique à fixer au plafond. Hauteur de fixation réglable.

Color Options  
Options de Couleur



LED Type / Type LED

Color Rendering Index / Indice de Rendu des Couleurs: (CRI): Ra>80

Code	Power Puissance (W)	LED Type Type De LED	LED Module Module LED	Lum. Flux Flux Lum. (lm)	Color Temperature Température De Couleur (K)	Dimensions (mm)			Weight Poids (kg)	Packing Quantity Colisage	Pcs./20" Container Pcs./20" Conteneur
						a	l	h			
PL7S12L15C	14	2835 SMD	PCB	1295	2700 - 6500	70	570	90	1.9	4	2910
PL7S12L25C	21	2835 SMD	PCB	1945	2700 - 6500	70	570	90	2.0	4	2910
PL7S13L15C	21	2835 SMD	PCB	1940	2700 - 6500	70	850	90	2.5	4	2910
PL7S13L25C	30	2835 SMD	PCB	2920	2700 - 6500	70	850	90	2.6	4	2910
PL7S14L15C	26	2835 SMD	PCB	2585	2700 - 6500	70	1130	90	3.1	4	2270
PL7S14L25C	41	2835 SMD	PCB	3890	2700 - 6500	70	1130	90	3.2	4	2270
PL7S15L15C	33	2835 SMD	PCB	3230	2700 - 6500	70	1412	90	3.7	4	1840
PL7S15L25C	51	2835 SMD	PCB	4865	2700 - 6500	70	1412	90	3.8	4	1840
PL7S16L15C	39	2835 SMD	PCB	3880	2700 - 6500	70	1693	90	4.3	4	1575
PL7S16L25C	61	2835 SMD	PCB	5835	2700 - 6500	70	1693	90	4.4	4	1575
PL7S17L15C	47	2835 SMD	PCB	4525	2700 - 6500	70	1973	90	4.9	4	1250
PL7S17L25C	70	2835 SMD	PCB	6810	2700 - 6500	70	1973	90	5.1	4	1250
PL7S18L15C	53	2835 SMD	PCB	5170	2700 - 6500	70	2254	90	5.5	4	1250
PL7S19L15C	60	2835 SMD	PCB	5815	2700 - 6500	70	2534	90	6.1	4	1250
PL7S10L15C	66	2835 SMD	PCB	6460	2700 - 6500	70	2815	90	6.7	4	1000

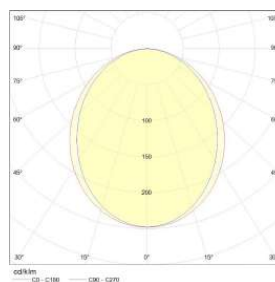
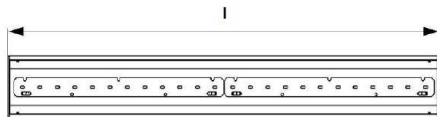
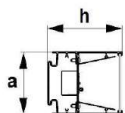

V / Hz 220 - 240 / 50 - 60

Options	Options
Dimmable electronic ballast or convertor. Emergency kit	Ballast électronique dimmable ou converteur. Kit d'urgence.
NOTE	NOTE
Given lumen values are net delivered luminaire output lumens.  Given power values are total consumed AC power of the luminaire.	Les valeurs de lumens données sont les lumens de sortie nets du luminaire.  Les valeurs de puissance données sont la puissance AC totale consommée du luminaire.



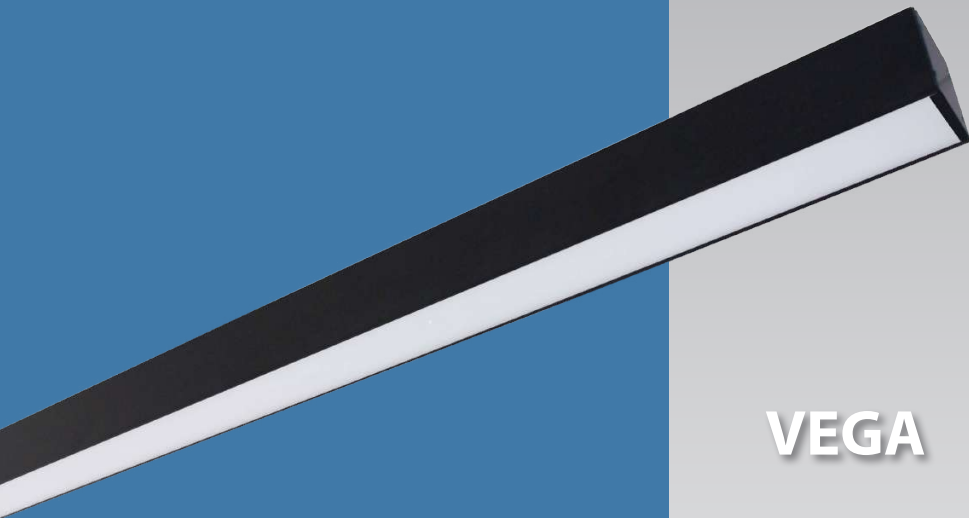

# VEGA

## LED

### Surface Mounted Lighting Fixtures With Frosted Diffuser Luminaires Apparents Avec Diffuseur Givré

#### APPLICATION AREAS

Shopping Malls  
Supermarkets  
Offices  
Meeting rooms  
Stores  
Hospitals  
Schools  
Corridors

#### DOMAINES D'UTILISATION

Centres Commerciaux  
Supermarchés  
Bureaux  
Salles de Réunions  
Magasins  
Hopitaux  
Ecoles  
Couloirs

#### BODY

Anodized aluminum with satin finishing. Black and white color options with elegant design.

#### DIFFUSER

UV stabilized frosted diffuser.

#### CONVERTER

Long life, low power loss converter with constant current. Compatible with ENEC standards.

#### LED

LED modules with 60.000 hours lifetime LUMILEDS / SAMSUNG / NICHIA brand LEDs.

#### CORPS

Corps en aluminium anodisé, satiné. Design élégant. Couleurs blanc, noir disponibles.

#### DIFFUSEUR

Diffuseur givré. Anti UV.

#### CONVERTEUR

Convertisseur, conforme aux normes ENEC. Longue vie. Perte de puissance faible avec courant constant.

#### LED

Modules LED – Durée de vie 60.000 heures avec LED de marque LUMILEDS / SAMSUNG / NICHIA.

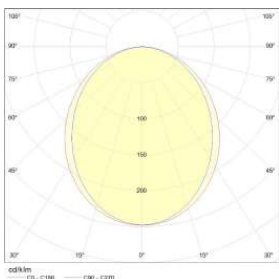

V / Hz	220 - 240 / 50 - 60
--------	---------------------

Options	Options
Dimmable electronic ballast or convertor.	Ballast électronique dimmable ou converteur.
Emergency kit	Kit d'urgence.

NOTE	NOTE
Given lumen values are net delivered luminaire output lumens.	Les valeurs de lumens données sont les lumens de sortie nets du luminaire.
Given power values are total consumed AC power of the luminaire.	Les valeurs de puissance données sont la puissance AC totale consommée du luminaire.

Color Options  
Options de Couleur



LED Type / Type LED

Color Rendering Index / Indice de Rendu des Couleurs: (CRI): Ra>80

Code	Power Puissance (W)	LED Type Type De LED	LED Module Module LED	Lum. Flux Flux Lum. (lm)	Color Temperature Température De Couleur (K)	Dimensions (mm)			Weight Poids (kg)	Packing Quantity Colisage	Pcs./20" Container Pcs./20" Conteneur
						a	l	h			
PL7U12L15C	14	2835 SMD	PCB	1295	2700 - 6500	70	570	90	1,7	4	2930
PL7U12L25C	21	2835 SMD	PCB	1945	2700 - 6500	70	570	90	1,7	4	2930
PL7U13L15C	21	2835 SMD	PCB	1940	2700 - 6500	70	850	90	2,3	4	2010
PL7U13L25C	30	2835 SMD	PCB	2920	2700 - 6500	70	850	90	2,3	4	2010
PL7U14L15C	26	2835 SMD	PCB	2585	2700 - 6500	70	1130	90	2,9	4	2270
PL7U14L25C	41	2835 SMD	PCB	3890	2700 - 6500	70	1130	90	2,9	4	2270
PL7U15L15C	33	2835 SMD	PCB	3230	2700 - 6500	70	1412	90	3,5	4	1835
PL7U15L15CSB	33	2835 SMD	PCB	3230	2700 - 6500	70	1408	90	3,5	4	1835
PL7U15L15CS0	33	2835 SMD	PCB	3230	2700 - 6500	70	1404	90	3,5	4	1835
PL7U15L25C	51	2835 SMD	PCB	4865	2700 - 6500	70	1412	90	3,5	4	1835
PL7U15L25CSB	51	2835 SMD	PCB	4865	2700 - 6500	70	1408	90	3,5	4	1835
PL7U15L25CS0	51	2835 SMD	PCB	4865	2700 - 6500	70	1404	90	3,5	4	1835
PL7U16L15C	39	2835 SMD	PCB	3880	2700 - 6500	70	1693	90	4,1	4	1575
PL7U16L15CSB	39	2835 SMD	PCB	3880	2700 - 6500	70	1689	90	4,1	4	1575
PL7U16L15CS0	39	2835 SMD	PCB	3880	2700 - 6500	70	1685	90	4,1	4	1575
PL7U16L25C	61	2835 SMD	PCB	5835	2700 - 6500	70	1693	90	4,1	4	1575
PL7U16L25CSB	61	2835 SMD	PCB	5835	2700 - 6500	70	1689	90	4,1	4	1575
PL7U16L25CS0	61	2835 SMD	PCB	5835	2700 - 6500	70	1685	90	4,1	4	1575
PL7U17L15C	47	2835 SMD	PCB	4525	2700 - 6500	70	1973	90	4,7	4	1250
PL7U17L15CSB	47	2835 SMD	PCB	4525	2700 - 6500	70	1969	90	4,7	4	1250
PL7U17L15CS0	47	2835 SMD	PCB	4525	2700 - 6500	70	1965	90	4,7	4	1250
PL7U17L25C	70	2835 SMD	PCB	6810	2700 - 6500	70	1973	90	4,7	4	1250
PL7U17L25CSB	70	2835 SMD	PCB	6810	2700 - 6500	70	1969	90	4,7	4	1250
PL7U17L25CS0	70	2835 SMD	PCB	6810	2700 - 6500	70	1965	90	4,7	4	1250
PL7U18L15C	53	2835 SMD	PCB	5170	2700 - 6500	70	2254	90	5,3	4	1250
PL7U18L15CSB	53	2835 SMD	PCB	5170	2700 - 6500	70	2250	90	5,3	4	1250
PL7U18L15CS0	53	2835 SMD	PCB	5170	2700 - 6500	70	2246	90	5,3	4	1250
PL7U19L15C	60	2835 SMD	PCB	5815	2700 - 6500	70	2534	90	5,9	4	1250
PL7U19L15CSB	60	2835 SMD	PCB	5815	2700 - 6500	70	2530	90	5,9	4	1250
PL7U19L15CS0	60	2835 SMD	PCB	5815	2700 - 6500	70	2526	90	5,9	4	1250
PL7U10L15C	66	2835 SMD	PCB	6460	2700 - 6500	70	2815	90	6,5	4	1000
PL7U10L15CSB	66	2835 SMD	PCB	6460	2700 - 6500	70	2811	90	6,5	4	1000
PL7U10L15CS0	66	2835 SMD	PCB	6460	2700 - 6500	70	2807	90	6,5	4	1000

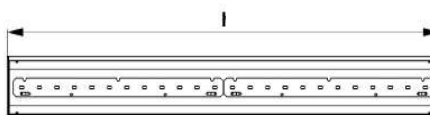
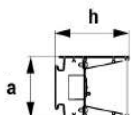



 **pamir**<sup>®</sup>  
aydinlatma





**OPTIMUM**



# OPTIMUM

## LED

### Suspended Lighting Fixtures With Frosted Diffuser

### Luminaire suspendus Avec Diffuseur Givré

#### APPLICATION AREAS

Shopping Malls  
Supermarkets  
Offices  
Meeting rooms  
Stores  
Hospitals  
Schools  
Corridors

#### DOMAINES D'UTILISATION

Centres Commerciaux  
Supermarchés  
Bureaux  
Salles de Réunions  
Magasins  
Hopitaux  
Ecoles  
Couloirs

#### BODY

Anodized aluminum with satin finishing. Black and white color options with elegant design.

#### DIFFUSER

UV stabilized frosted diffuser.

#### CONVERTER

Long life, low power loss converter with constant current. Compatible with ENEC standards.

#### LED

LED modules with 60.000 hours lifetime LUMILEDS / SAMSUNG / NICHIA brand LEDs.

#### SUSPENSION

Composed of 1mm steel wire rope and nickel-plated brass components. Suspension height is adjustable. Supplied with transparent electric cord and ceiling mounted electrical junction box with aesthetic design

#### CORPS

Corps en aluminium anodisé, satiné. Design élégant. Couleurs blanc, noir disponibles.

#### DIFFUSEUR

Diffuseur givré. Anti UV.

#### CONVERTEUR

Convertisseur, conforme aux normes ENEC. Longue vie. Perte de puissance faible avec courant constant.

#### LED

Modules LED – Durée de vie 60.000 heures avec LED de marque LUMILEDS / SAMSUNG / NICHIA.

#### SYSTEME DE FIXATION

Composé d'un fil en acier de 1mm, de composants en laiton nickelés. Livré avec un cordon électrique transparent et une boîte de jonction électrique à fixer au plafond. Hauteur de fixation réglable.

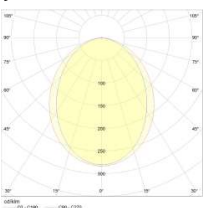

V / Hz 220 - 240 / 50 - 60

Options	Options
Dimmable electronic ballast or convertor.	Ballast électronique dimmable ou converteur.
Emergency kit	Kit d'urgence.

NOTE	NOTE
Given lumen values are net delivered luminaire output lumens.	Les valeurs de lumens données sont les lumens de sortie nets du luminaire.
Given power values are total consumed AC power of the luminaire.	Les valeurs de puissance données sont la puissance AC totale consommée du luminaire.

Color Options  
Options de Couleur



LED Type / Type LED

Color Rendering Index / Indice de Rendu des Couleurs: (CRI): Ra>80

Code	Power Puissance (W)	LED Type Type De LED	LED Module Module LED	Lum. Flux Flux Lum. (lm)	Color Temperature Température De Couleur (K)	Dimensions (mm)			Weight Poids (kg)	Packing Quantity Colisage	Pcs./20" Container Pcs./20" Conteneur
						a	l	h			
PL17S9C02C	15	2835 SMD	PCB	1375	2700 - 6500	63	675	88	1.9	5	3635
PL17S9C03C	20	2835 SMD	PCB	1815	2700 - 6500	63	675	88	1.9	5	3635
PL17S9C04C	26	2835 SMD	PCB	2210	2700 - 6500	63	675	88	1.9	5	3635
PL17S12C02C	19	2835 SMD	PCB	1830	2700 - 6500	63	895	88	2.3	5	3635
PL17S12C03C	27	2835 SMD	PCB	2420	2700 - 6500	63	895	88	2.3	5	3635
PL17S12C04C	35	2835 SMD	PCB	2945	2700 - 6500	63	895	88	2.3	5	3635
PL17S15C02C	24	2835 SMD	PCB	2285	2700 - 6500	63	1115	88	2.7	5	2835
PL17S15C03C	33	2835 SMD	PCB	3025	2700 - 6500	63	1115	88	2.7	5	2835
PL17S15C04C	43	2835 SMD	PCB	3680	2700 - 6500	63	1115	88	2.7	5	2835
PL17S18C02C	29	2835 SMD	PCB	2745	2700 - 6500	63	1334	88	3.1	5	2295
PL17S18C03C	40	2835 SMD	PCB	3630	2700 - 6500	63	1334	88	3.1	5	2295
PL17S18C04C	51	2835 SMD	PCB	4420	2700 - 6500	63	1334	88	3.1	5	2295
PL17S21C02C	33	2835 SMD	PCB	3200	2700 - 6500	63	1554	88	3.5	5	2295
PL17S21C03C	47	2835 SMD	PCB	4235	2700 - 6500	63	1554	88	3.5	5	2295
PL17S21C04C	60	2835 SMD	PCB	5155	2700 - 6500	63	1554	88	3.5	5	2295
PL17S24C02C	38	2835 SMD	PCB	3660	2700 - 6500	63	1774	88	3.9	5	1970
PL17S24C03C	53	2835 SMD	PCB	4840	2700 - 6500	63	1774	88	3.9	5	1970
PL17S24C04C	69	2835 SMD	PCB	5890	2700 - 6500	63	1774	88	3.9	5	1970
PL17S27C02C	43	2835 SMD	PCB	4115	2700 - 6500	63	1994	88	4.3	5	1560
PL17S27C03C	60	2835 SMD	PCB	5445	2700 - 6500	63	1994	88	4.3	5	1560
PL17S27C04C	77	2835 SMD	PCB	6625	2700 - 6500	63	1994	88	4.3	5	1560
PL17S30C02C	48	2835 SMD	PCB	4570	2700 - 6500	63	2214	88	4.7	5	1560
PL17S30C03C	67	2835 SMD	PCB	6050	2700 - 6500	63	2214	88	4.7	5	1560
PL17S30C04C	86	2835 SMD	PCB	7360	2700 - 6500	63	2214	88	4.7	5	1560

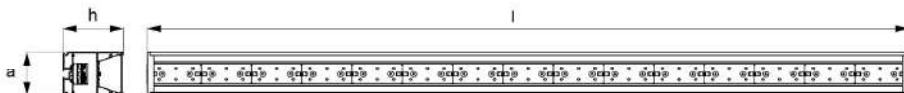

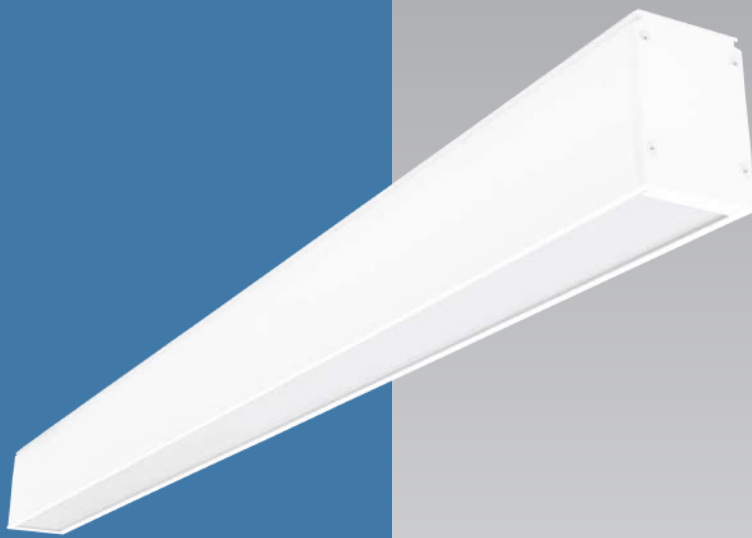

# OPTIMUM

## LED

### Surface Mounted Lighting Fixtures With Frosted Diffuser Luminaires Apparents Avec Diffuseur Givré

#### APPLICATION AREAS

Shopping Malls  
Supermarkets  
Offices  
Meeting rooms  
Stores  
Hospitals  
Schools  
Corridors

#### DOMAINES D'UTILISATION

Centres Commerciaux  
Supermarchés  
Bureaux  
Salles de Réunions  
Magasins  
Hopitaux  
Ecoles  
Couloirs

#### BODY

Anodized aluminum with satin finishing. Black and white color options with elegant design.

#### DIFFUSER

UV stabilized frosted diffuser.

#### CONVERTER

Long life, low power loss converter with constant current. Compatible with ENEC standards.

#### LED

LED modules with 60.000 hours lifetime LUMILEDS / SAMSUNG / NICHIA brand LEDs.

#### CORPS

Corps en aluminium anodisé, satiné. Design élégant. Couleurs blanc, noir disponibles.

#### DIFFUSEUR

Diffuseur givré. Anti UV.

#### CONVERTEUR

Convertisseur, conforme aux normes ENEC. Longue vie. Perte de puissance faible avec courant constant.

#### LED

Modules LED – Durée de vie 60.000 heures avec LED de marque LUMILEDS / SAMSUNG / NICHIA.

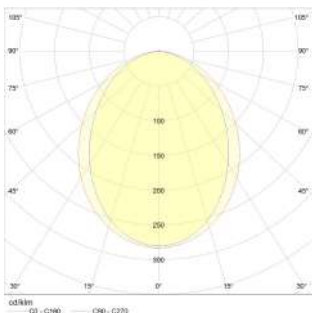

V / Hz 220 - 240 / 50 - 60

Options	Options
Dimmable electronic ballast or convertor.	Ballast électronique dimmable ou converteur.
Emergency kit	Kit d'urgence.

NOTE	NOTE
Given lumen values are net delivered luminaire output lumens.	Les valeurs de lumens données sont les lumens de sortie nets du luminaire.
Given power values are total consumed AC power of the luminaire.	Les valeurs de puissance données sont la puissance AC totale consommée du luminaire.

Color Options  
Options de Couleur



LED Type / Type LED

Color Rendering Index / Indice de Rendu des Couleurs: (CRI): Ra>80

Code	Power Puissance (W)	LED Type Type De LED	LED Module Module LED	Lum. Flux Flux Lum. (lm)	Color Temperature Température De Couleur (K)	Dimensions (mm)			Weight Poids (kg)	Packing Quantity Colisage	Pcs./20" Container Pcs./20" Conteneur
						a	l	h			
PL17U9C02C	15	2835 SMD	PCB	1375	2700 - 6500	63	675	88	1.9	5	3635
PL17U9C03C	20	2835 SMD	PCB	1815	2700 - 6500	63	675	88	1.9	5	3635
PL17U9C04C	26	2835 SMD	PCB	2210	2700 - 6500	63	675	88	1.9	5	3635
PL17U12C02C	19	2835 SMD	PCB	1830	2700 - 6500	63	895	88	2.3	5	3635
PL17U12C03C	27	2835 SMD	PCB	2420	2700 - 6500	63	895	88	2.3	5	3635
PL17U12C04C	35	2835 SMD	PCB	2945	2700 - 6500	63	895	88	2.3	5	3635
PL17U15C02C	24	2835 SMD	PCB	2285	2700 - 6500	63	1115	88	2.7	5	2835
PL17U15C03C	33	2835 SMD	PCB	3025	2700 - 6500	63	1115	88	2.7	5	2835
PL17U15C04C	43	2835 SMD	PCB	3680	2700 - 6500	63	1115	88	2.7	5	2835
PL17U18C02C	29	2835 SMD	PCB	2745	2700 - 6500	63	1334	88	3.1	5	2295
PL17U18C03C	40	2835 SMD	PCB	3630	2700 - 6500	63	1334	88	3.1	5	2295
PL17U18C04C	51	2835 SMD	PCB	4420	2700 - 6500	63	1334	88	3.1	5	2295
PL17U21C02C	33	2835 SMD	PCB	3200	2700 - 6500	63	1554	88	3.5	5	2295
PL17U21C03C	47	2835 SMD	PCB	4235	2700 - 6500	63	1554	88	3.5	5	2295
PL17U21C04C	60	2835 SMD	PCB	5155	2700 - 6500	63	1554	88	3.5	5	2295
PL17U24C02C	38	2835 SMD	PCB	3660	2700 - 6500	63	1774	88	3.9	5	1970
PL17U24C03C	53	2835 SMD	PCB	4840	2700 - 6500	63	1774	88	3.9	5	1970
PL17U24C04C	69	2835 SMD	PCB	5890	2700 - 6500	63	1774	88	3.9	5	1970
PL17U27C02C	43	2835 SMD	PCB	4115	2700 - 6500	63	1994	88	4.3	5	1560
PL17U27C03C	60	2835 SMD	PCB	5445	2700 - 6500	63	1994	88	4.3	5	1560
PL17U27C04C	77	2835 SMD	PCB	6625	2700 - 6500	63	1994	88	4.3	5	1560
PL17U30C02C	48	2835 SMD	PCB	4570	2700 - 6500	63	2214	88	4.7	5	1560
PL17U30C03C	67	2835 SMD	PCB	6050	2700 - 6500	63	2214	88	4.7	5	1560
PL17U30C04C	86	2835 SMD	PCB	7360	2700 - 6500	63	2214	88	4.7	5	1560

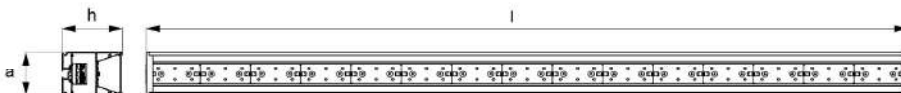



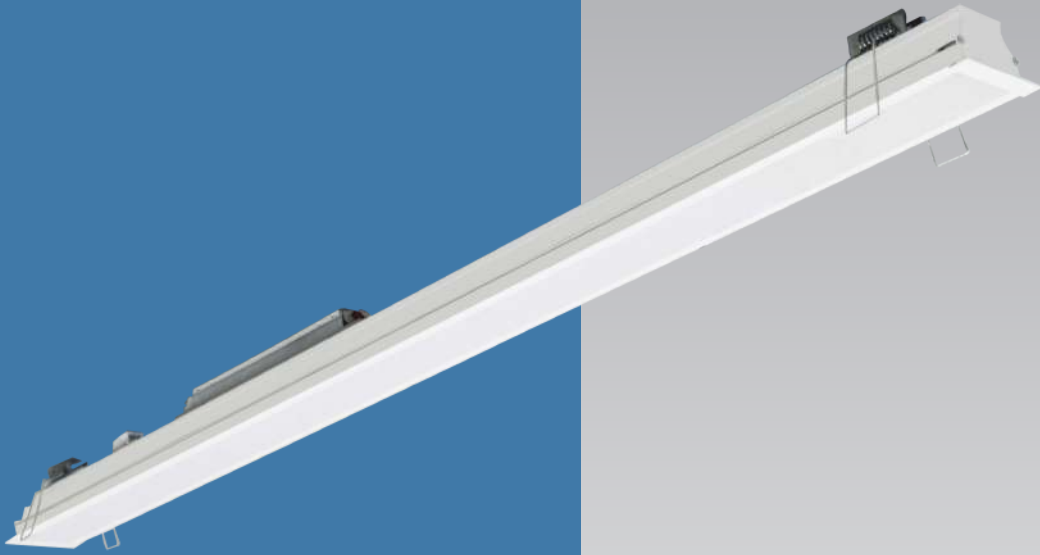

# OPTIMUM RECESSED

## LED

### Recessed Lighting Fixtures With Diffuser

### Luminaire Encastré Avec Diffuseur

#### APPLICATION AREAS

Shopping Malls  
Supermarkets  
Offices  
Meeting rooms  
Stores  
Hospitals  
Schools

#### DOMAINES D'UTILISATION

Centres Commerciaux  
Supermarchés  
Bureaux  
Salles de Réunions  
Magasins  
Hopitaux  
Ecoles

#### BODY

Anodized aluminum with satin finishing. Black and white color options with elegant design.

#### DIFFUSER

UV stabilized extruded PC diffuser.

#### CONVERTER

Long life, low power loss converter with constant current. Compatible with ENEC standards.

#### LED

LED modules with 60.000 hours lifetime LUMILEDS / SAMSUNG / NICHIA brand LEDs.

#### CORPS

Corps en aluminium anodisé, satiné. Design élégant. Couleurs blanc, noir disponibles.

#### DIFFUSEUR

Diffuseur en PC extrudé stabilisé aux UV.

#### CONVERTEUR

Convertisseur, conforme aux normes ENEC. Longue vie. Perte de puissance faible avec courant constant.

#### LED

Modules LED – Durée de vie 60.000 heures avec LED de marque LUMILEDS / SAMSUNG / NICHIA.

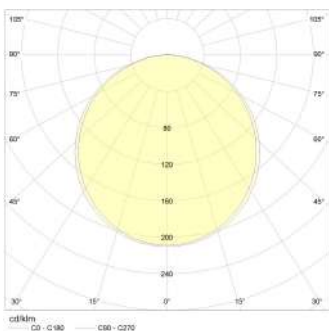

V / Hz 220 - 240 / 50 - 60

#### Options

Dimmable electronic ballast or convertor.  
Emergency kit

#### Options

Ballast électronique dimmable ou converteur.  
Kit d'urgence.

#### NOTE

Given lumen values are net delivered luminaire output lumens.

Given power values are total consumed AC power of the luminaire.

#### NOTE

Les valeurs de lumens données sont les lumens de sortie nets du luminaire.

Les valeurs de puissance données sont la puissance AC totale consommée du luminaire.

Color Options  
Options de Couleur



LED Type / Type LED

Color Rendering Index / Indice de Rendu des Couleurs: (CRI): Ra>80

Code	Power Puissance (W)	LED Type Type De LED	LED Module Module LED	Lum. Flux Flux Lum. (lm)	Color Temperature Température De Couleur (K)	Dimensions (mm)			Weight Poids (kg)	Packing Quantity Colisage	Pcs./20" Container Pcs./20" Conteneur
						a	l	h			
PL18A9C02C	15	2835 SMD	PCB	1265	2700 - 6500	57	672	63	0.9	6	4360
PL18A9C03C	20	2835 SMD	PCB	1675	2700 - 6500	57	672	63	0.9	6	4360
PL18A9C04C	26	2835 SMD	PCB	2030	2700 - 6500	57	672	63	0.9	6	4360
PL18A12C02C	19	2835 SMD	PCB	1690	2700 - 6500	57	892	63	1.1	6	4360
PL18A12C03C	27	2835 SMD	PCB	2235	2700 - 6500	57	892	63	1.1	6	4360
PL18A12C04C	35	2835 SMD	PCB	2705	2700 - 6500	57	892	63	1.1	6	4360
PL18A15C02C	24	2835 SMD	PCB	2110	2700 - 6500	57	1112	63	1.3	6	3400
PL18A15C03C	33	2835 SMD	PCB	2790	2700 - 6500	57	1112	63	1.3	6	3400
PL18A15C04C	43	2835 SMD	PCB	3380	2700 - 6500	57	1112	63	1.3	6	3400
PL18A18C02C	29	2835 SMD	PCB	2535	2700 - 6500	57	1331	63	1.5	6	2750
PL18A18C03C	40	2835 SMD	PCB	3350	2700 - 6500	57	1331	63	1.5	6	2750
PL18A18C04C	51	2835 SMD	PCB	4055	2700 - 6500	57	1331	63	1.5	6	2750
PL18A21C02C	33	2835 SMD	PCB	2955	2700 - 6500	57	1551	63	1.7	6	2750
PL18A21C03C	47	2835 SMD	PCB	3910	2700 - 6500	57	1551	63	1.7	6	2750
PL18A21C04C	60	2835 SMD	PCB	4730	2700 - 6500	57	1551	63	1.7	6	2750
PL18A24C02C	38	2835 SMD	PCB	3375	2700 - 6500	57	1771	63	2.0	6	2360
PL18A24C03C	53	2835 SMD	PCB	4465	2700 - 6500	57	1771	63	2.0	6	2360
PL18A24C04C	69	2835 SMD	PCB	5405	2700 - 6500	57	1771	63	2.0	6	2360
PL18A27C02C	43	2835 SMD	PCB	3800	2700 - 6500	57	1991	63	2.2	6	1870
PL18A27C03C	60	2835 SMD	PCB	5025	2700 - 6500	57	1991	63	2.2	6	1870
PL18A27C04C	77	2835 SMD	PCB	6085	2700 - 6500	57	1991	63	2.2	6	1870
PL18A30C02C	48	2835 SMD	PCB	4220	2700 - 6500	57	2211	63	2.4	6	1870
PL18A30C03C	67	2835 SMD	PCB	5585	2700 - 6500	57	2211	63	2.4	6	1870
PL18A30C04C	86	2835 SMD	PCB	6760	2700 - 6500	57	2211	63	2.4	6	1870

Visible Frame Width / Largeur de Cadre Visible: 72mm







**VEGA SLIM**

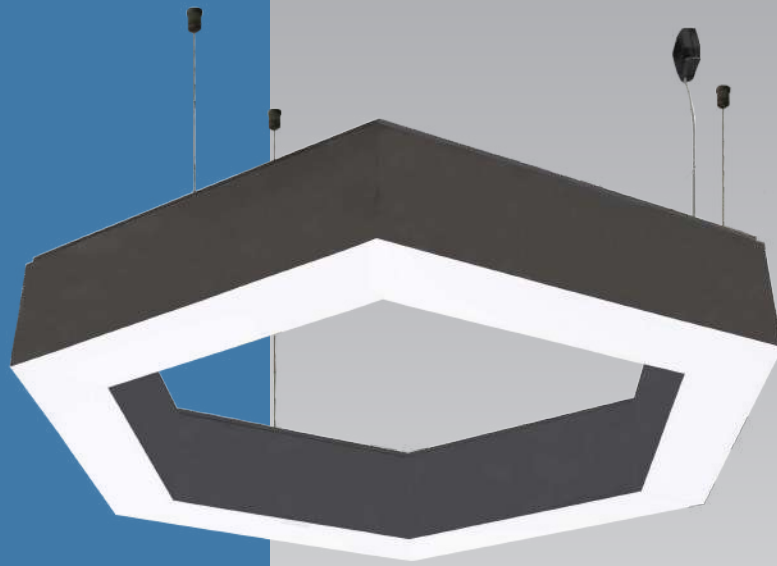

## HEXAGON VEGA SLIM

### LED

#### Suspended Lighting Fixtures With Diffuser

#### Luminaire suspendus Avec Diffuseur

#### APPLICATION AREAS

Shopping Malls  
Supermarkets  
Offices  
Meeting rooms  
Stores  
Hospitals  
Schools  
Corridors

#### DOMAINES D'UTILISATION

Centres Commerciaux  
Supermarchés  
Bureaux  
Salles de Réunions  
Magasins  
Hopitaux  
Ecoles  
Couloirs

#### BODY

Anodized aluminum with satin finishing. Black and white color options with elegant design.

#### DIFFUSER

UV stabilized extruded PC diffuser.

#### CONVERTER

Long life, low power loss converter with constant current. Compatible with ENEC standards.

#### LED

LED modules with 60.000 hours lifetime LUMILEDS / SAMSUNG / NICHIA brand LEDs.

#### SUSPENSION

Composed of 1mm steel wire rope and nickel-plated brass components. Suspension height is adjustable. Supplied with transparent electric cord and ceiling mounted electrical junction box with aesthetic design

#### CORPS

Corps en aluminium anodisé, satiné. Design élégant. Couleurs blanc, noir disponibles.

#### DIFFUSEUR

Diffuseur en PC extrudé stabilisé aux UV.

#### CONVERTEUR

Convertisseur, conforme aux normes ENEC. Longue vie. Perte de puissance faible avec courant constant.

#### LED

Modules LED – Durée de vie 60.000 heures avec LED de marque LUMILEDS / SAMSUNG / NICHIA.

#### SYSTEME DE FIXATION

Composé d'un fil en acier de 1mm, de composants en laiton nickelés. Livré avec un cordon électrique transparent et une boîte de jonction électrique à fixer au plafond. Hauteur de fixation réglable.

Color Options  
Options de Couleur



LED Type / Type LED

Color Rendering Index / Indice de Rendu des Couleurs: (CRI): Ra>80

Code	Power Puissance (W)	LED Type Type De LED	LED Module Module LED	Lum. Flux Flux Lum. (lm)	Color Temperature Température De Couleur (K)	Dimensions (mm)			Weight Poids (kg)	Packing Quantity Colisage	Pcs./20" Container Pcs./20" Conteneur
						a	b	h			
PL13SA61L15C	39	2835 SMD	PCB	3365	2700 - 6500	641	555	85	6.5	4	470
PL13SA61L25C	61	2835 SMD	PCB	5065	2700 - 6500	641	555	85	9.1	4	470
PL13SA62L15C	79	2835 SMD	PCB	6730	2700 - 6500	1202	1041	85	12.2	4	140
PL13SA62L25C	120	2835 SMD	PCB	10125	2700 - 6500	1202	1041	85	15.3	4	140
PL13SA63L15C	118	2835 SMD	PCB	10090	2700 - 6500	1763	1527	85	12.2	4	70
PL13SA63L25C	180	2835 SMD	PCB	15190	2700 - 6500	1763	1527	85	15.3	4	70

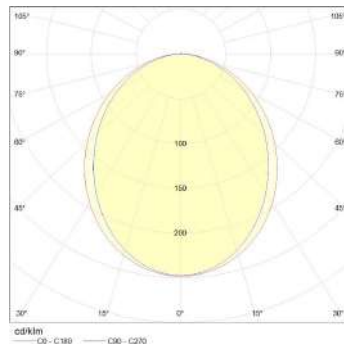
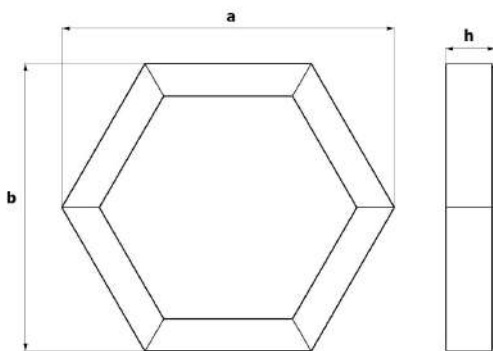
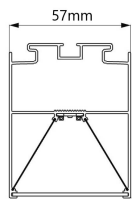

V / Hz 220 - 240 / 50 - 60

Options	Options
Dimmable electronic ballast or convertor. Emergency kit	Ballast électronique dimmable ou converteur. Kit d'urgence.
NOTE	NOTE
Given lumen values are net delivered luminaire output lumens.	Les valeurs de lumens données sont les lumens de sortie nets du luminaire.
Given power values are total consumed AC power of the luminaire.	Les valeurs de puissance données sont la puissance AC totale consommée du luminaire.

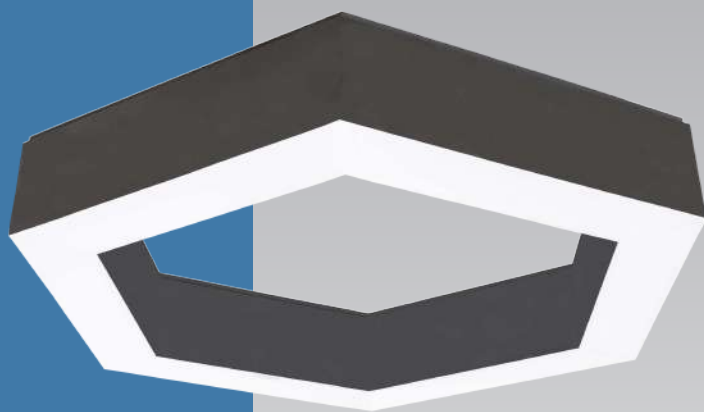

## HEXAGON VEGA SLIM

### LED

Surface Mounted Lighting Fixtures With Diffuser

Luminaire Apparents Avec Diffuseur

#### APPLICATION AREAS

Shopping Malls  
Supermarkets  
Offices  
Meeting rooms  
Stores  
Hospitals  
Schools  
Corridors

#### DOMAINES D'UTILISATION

Centres Commerciaux  
Supermarchés  
Bureaux  
Salles de Réunions  
Magasins  
Hopitaux  
Ecoles  
Couloirs

#### BODY

Anodized aluminum with satin finishing. Black and white color options with elegant design.

#### DIFFUSER

UV stabilized extruded PC diffuser.

#### CONVERTER

Long life, low power loss converter with constant current. Compatible with ENEC standards.

#### LED

LED modules with 60.000 hours lifetime LUMILEDS / SAMSUNG / NICHIA brand LEDs.

#### CORPS

Corps en aluminium anodisé, satiné. Design élégant. Couleurs blanc, noir disponibles.

#### DIFFUSEUR

Diffuseur en PC extrudé stabilisé aux UV.

#### CONVERTEUR

Convertisseur, conforme aux normes ENEC. Longue vie. Perte de puissance faible avec courant constant.

#### LED

Modules LED – Durée de vie 60.000 heures avec LED de marque LUMILEDS / SAMSUNG / NICHIA.

Color Options  
Options de Couleur



LED Type / Type LED

Color Rendering Index / Indice de Rendu des Couleurs: (CRI): Ra>80

Code	Power Puissance (W)	LED Type Type De LED	LED Module Module LED	Lum. Flux Flux Lum. (lm)	Color Temperature Température De Couleur (K)	Dimensions (mm)			Weight Poids (kg)	Packing Quantity Colisage	Pcs./20" Container Pcs./20" Conteneur
						a	b	h			
PL13UA61L15C	39	2835 SMD	PCB	3365	2700 - 6500	641	555	85	6.5	4	470
PL13UA61L25C	61	2835 SMD	PCB	5065	2700 - 6500	641	555	85	9.1	4	470
PL13UA62L15C	79	2835 SMD	PCB	6730	2700 - 6500	1202	1041	85	12.2	4	140
PL13UA62L25C	120	2835 SMD	PCB	10125	2700 - 6500	1202	1041	85	15.3	4	140
PL13UA63L15C	118	2835 SMD	PCB	10090	2700 - 6500	1763	1527	85	12.2	4	70
PL13UA63L25C	180	2835 SMD	PCB	15190	2700 - 6500	1763	1527	85	15.3	4	70

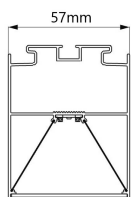
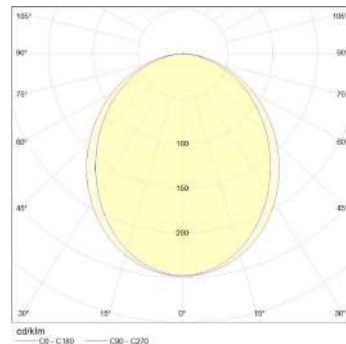
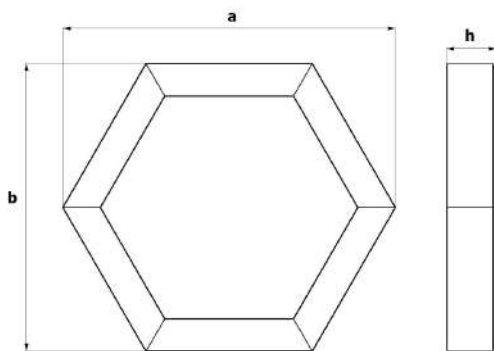

V / Hz 220 - 240 / 50 - 60

Options	Options
Dimmable electronic ballast or convertor. Emergency kit	Ballast électronique dimmable ou converteur. Kit d'urgence.
NOTE	NOTE
Given lumen values are net delivered luminaire output lumens.	Les valeurs de lumens données sont les lumens de sortie nets du luminaire.
Given power values are total consumed AC power of the luminaire.	Les valeurs de puissance données sont la puissance AC totale consommée du luminaire.





## VEGA SLIM

### LED

#### Suspended Lighting Fixtures With Diffuser

#### Luminaire suspendu Avec Diffuseur

#### APPLICATION AREAS

Shopping Malls  
Supermarkets  
Offices  
Meeting rooms  
Stores  
Hospitals  
Schools  
Corridors

#### DOMAINES D'UTILISATION

Centres Commerciaux  
Supermarchés  
Bureaux  
Salles de Réunions  
Magasins  
Hopitaux  
Ecoles  
Couloirs

#### BODY

Anodized aluminum with satin finishing. Black and white color options with elegant design.

#### DIFFUSER

UV stabilized extruded PC diffuser.

#### CONVERTER

Long life, low power loss converter with constant current. Compatible with ENEC standards.

#### LED

LED modules with 60.000 hours lifetime LUMILEDS / SAMSUNG / NICHIA brand LEDs.

#### SUSPENSION

Composed of 1mm steel wire rope and nickel-plated brass components. Suspension height is adjustable. Supplied with transparent electric cord and ceiling mounted electrical junction box with aesthetic design

#### CORPS

Corps en aluminium anodisé, satiné. Design élégant. Couleurs blanc, noir disponibles.

#### DIFFUSEUR

Diffuseur en PC extrudé stabilisé aux UV.

#### CONVERTEUR

Convertisseur, conforme aux normes ENEC. Longue vie. Perte de puissance faible avec courant constant.

#### LED

Modules LED – Durée de vie 60.000 heures avec LED de marque LUMILEDS / SAMSUNG / NICHIA.

#### SYSTEME DE FIXATION

Composé d'un fil en acier de 1mm, de composants en laiton nickelés. Livré avec un cordon électrique transparent et une boîte de jonction électrique à fixer au plafond. Hauteur de fixation réglable.

Color Options  
Options de Couleur



LED Type / Type LED

Color Rendering Index / Indice de Rendu des Couleurs: (CRI): Ra>80

Code	Power Puissance (W)	LED Type Type De LED	LED Module Module LED	Lum. Flux Flux Lum. (lm)	Color Temperature Température De Couleur (K)	Dimensions (mm)			Weight Poids (kg)	Packing Quantity Colisage	Pcs./20" Container Pcs./20" Conteneur
						a	l	h			
PL13S12L15C	14	2835 SMD	PCB	990	2700 - 6500	57	570	85	1.5	5	3635
PL13S12L25C	21	2835 SMD	PCB	1490	2700 - 6500	57	570	85	1.6	5	3635
PL13S13L15C	21	2835 SMD	PCB	1485	2700 - 6500	57	850	85	1.9	5	3635
PL13S13L25C	30	2835 SMD	PCB	2230	2700 - 6500	57	850	85	2.0	5	3635
PL13S14L15C	26	2835 SMD	PCB	1980	2700 - 6500	57	1130	85	2.3	5	2835
PL13S14L25C	41	2835 SMD	PCB	2975	2700 - 6500	57	1130	85	2.4	5	2835
PL13S15L15C	33	2835 SMD	PCB	2470	2700 - 6500	57	1412	85	2.7	5	2295
PL13S15L25C	51	2835 SMD	PCB	3720	2700 - 6500	57	1412	85	2.8	5	2295
PL13S16L15C	39	2835 SMD	PCB	2965	2700 - 6500	57	1693	85	3.1	5	1970
PL13S16L25C	61	2835 SMD	PCB	4465	2700 - 6500	57	1693	85	3.2	5	1970
PL13S17L15C	47	2835 SMD	PCB	3460	2700 - 6500	57	1973	85	3.5	5	1560
PL13S17L25C	70	2835 SMD	PCB	5205	2700 - 6500	57	1973	85	3.5	5	1560
PL13S18L15C	53	2835 SMD	PCB	3955	2700 - 6500	57	2254	85	3.9	5	1560
PL13S19L15C	60	2835 SMD	PCB	4450	2700 - 6500	57	2534	85	4.3	5	1255
PL13S10L15C	66	2835 SMD	PCB	4940	2700 - 6500	57	2815	85	4.7	5	1255

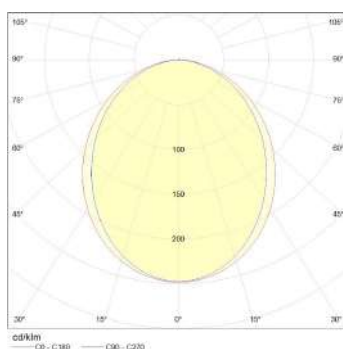
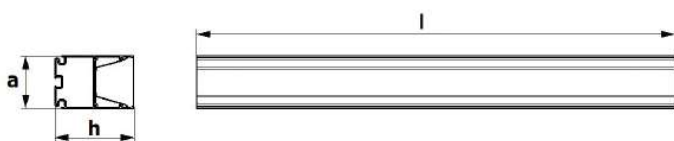

V / Hz 220 - 240 / 50 - 60

Options	Options
Dimmable electronic ballast or convertor. Emergency kit	Ballast électronique dimmable ou converteur. Kit d'urgence.
NOTE	NOTE
Given lumen values are net delivered luminaire output lumens.	Les valeurs de lumens données sont les lumens de sortie nets du luminaire.
Given power values are total consumed AC power of the luminaire.	Les valeurs de puissance données sont la puissance AC totale consommée du luminaire.



# VEGA SLIM

## LED

### Surface Mounted Lighting Fixtures With Diffuser

### Luminaire Apparents Avec Diffuseur

#### BODY

Anodized aluminum with satin finishing. Black and white color options with elegant design.

#### DIFFUSER

UV stabilized extruded PC diffuser.

#### CONVERTER

Long life, low power loss converter with constant current. Compatible with ENEC standards.

#### LED

LED modules with 60.000 hours lifetime LUMILEDS / SAMSUNG / NICHIA brand LEDs.

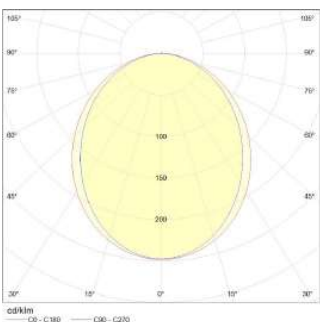

#### APPLICATION AREAS

Shopping Malls  
Supermarkets  
Offices  
Meeting rooms  
Stores  
Hospitals  
Schools  
Corridors

#### DOMAINES D'UTILISATION

Centres Commerciaux  
Supermarchés  
Bureaux  
Salles de Réunions  
Magasins  
Hopitaux  
Ecoles  
Couloirs

#### CORPS

Corps en aluminium anodisé, satiné. Design élégant. Couleurs blanc, noir disponibles.

#### DIFFUSEUR

Diffuseur en PC extrudé stabilisé aux UV.

#### CONVERTEUR

Convertisseur, conforme aux normes ENEC. Longue vie. Perte de puissance faible avec courant constant.

#### LED

Modules LED – Durée de vie 60.000 heures avec LED de marque LUMILEDS / SAMSUNG / NICHIA.

V / Hz		220 - 240 / 50 - 60	
<b>Options</b>	<b>Options</b>	<b>NOTE</b>	<b>NOTE</b>
Dimmable electronic ballast or convertor. Emergency kit	Ballast électronique dimmable ou converteur. Kit d'urgence.	Given lumen values are net delivered luminaire output lumens.  Given power values are total consumed AC power of the luminaire.	Les valeurs de lumens données sont les lumens de sortie nets du luminaire.  Les valeurs de puissance données sont la puissance AC totale consommée du luminaire.

Color Options  
Options de Couleur



LED Type / Type LED

Color Rendering Index / Indice de Rendu des Couleurs: (CRI): Ra>80

Code	Power Puissance (W)	LED Type Type De LED	LED Module Module LED	Lum. Flux Flux Lum. (lm)	Color Temperature Température De Couleur (K)	Dimensions (mm)			Weight Poids (kg)	Packing Quantity Colisage	Pcs./20" Container Pcs./20" Conteneur
						a	l	h			
PL13U12L15C	14	2835 SMD	PCB	990	2700 - 6500	57	570	85	1.3	5	3635
PL13U12L25C	21	2835 SMD	PCB	1490	2700 - 6500	57	570	85	1.4	5	3635
PL13U13L15C	21	2835 SMD	PCB	1485	2700 - 6500	57	850	85	1.7	5	3635
PL13U13L25C	30	2835 SMD	PCB	2230	2700 - 6500	57	850	85	1.8	5	3635
PL13U14L15C	26	2835 SMD	PCB	1980	2700 - 6500	57	1130	85	2.1	5	2835
PL13U14L25C	41	2835 SMD	PCB	2975	2700 - 6500	57	1130	85	2.2	5	2835
PL13U15L15C	33	2835 SMD	PCB	2470	2700 - 6500	57	1412	85	2.5	5	2295
PL13U15L15CSB	33	2835 SMD	PCB	2470	2700 - 6500	57	1408	85	2.5	5	2295
PL13U15L15CSO	33	2835 SMD	PCB	2470	2700 - 6500	57	1404	85	2.5	5	2295
PL13U15L25C	51	2835 SMD	PCB	3720	2700 - 6500	57	1412	85	2.6	5	2295
PL13U15L25CSB	51	2835 SMD	PCB	3720	2700 - 6500	57	1408	85	2.6	5	2295
PL13U15L25CSO	51	2835 SMD	PCB	3720	2700 - 6500	57	1404	85	2.6	5	2295
PL13U16L15C	39	2835 SMD	PCB	2965	2700 - 6500	57	1693	85	2.9	5	1970
PL13U16L15CSB	39	2835 SMD	PCB	2965	2700 - 6500	57	1689	85	2.9	5	1970
PL13U16L15CSO	39	2835 SMD	PCB	2965	2700 - 6500	57	1685	85	2.9	5	1970
PL13U16L25C	61	2835 SMD	PCB	4465	2700 - 6500	57	1693	85	3.0	5	1970
PL13U16L25CSB	61	2835 SMD	PCB	4465	2700 - 6500	57	1689	85	3.0	5	1970
PL13U16L25CSO	61	2835 SMD	PCB	4465	2700 - 6500	57	1685	85	3.0	5	1970
PL13U17L15C	47	2835 SMD	PCB	3460	2700 - 6500	57	1973	85	3.3	5	1560
PL13U17L15CSB	47	2835 SMD	PCB	3460	2700 - 6500	57	1969	85	3.3	5	1560
PL13U17L15CSO	47	2835 SMD	PCB	3460	2700 - 6500	57	1965	85	3.3	5	1560
PL13U17L25C	70	2835 SMD	PCB	5205	2700 - 6500	57	1973	85	3.3	5	1560
PL13U17L25CSB	70	2835 SMD	PCB	5205	2700 - 6500	57	1969	85	3.3	5	1560
PL13U17L25CSO	70	2835 SMD	PCB	5205	2700 - 6500	57	1965	85	3.3	5	1560
PL13U18L15C	53	2835 SMD	PCB	3955	2700 - 6500	57	2254	85	3.7	5	1560
PL13U18L15CSB	53	2835 SMD	PCB	3955	2700 - 6500	57	2250	85	3.7	5	1560
PL13U18L15CSO	53	2835 SMD	PCB	3955	2700 - 6500	57	2246	85	3.7	5	1560
PL13U19L15C	60	2835 SMD	PCB	4450	2700 - 6500	57	2534	85	4.1	5	1255
PL13U19L15CSB	60	2835 SMD	PCB	4450	2700 - 6500	57	2530	85	4.1	5	1255
PL13U19L15CSO	60	2835 SMD	PCB	4450	2700 - 6500	57	2526	85	4.1	5	1255
PL13U10L15C	66	2835 SMD	PCB	4940	2700 - 6500	57	2815	85	4.5	5	1255
PL13U10L15CSB	66	2835 SMD	PCB	4940	2700 - 6500	57	2811	85	4.5	5	1255
PL13U10L15CSO	66	2835 SMD	PCB	4940	2700 - 6500	57	2807	85	4.5	5	1255

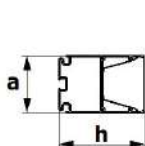





**SIMETRI**

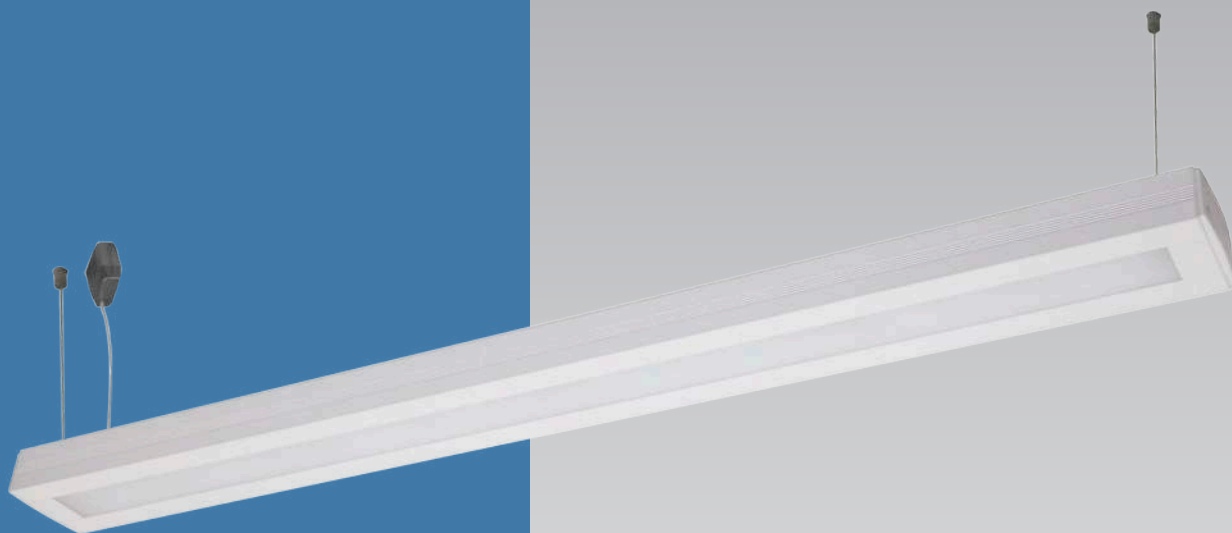

## SIMETRI

### LED

#### Suspended Lighting Fixtures With Frosted Diffuser

#### Luminaire Suspendus Avec Diffuseur Givré

#### APPLICATION AREAS

Shopping Malls  
Supermarkets  
Offices  
Meeting rooms  
Stores  
Hospitals  
Schools  
Corridors

#### DOMAINES D'UTILISATION

Centres Commerciaux  
Supermarchés  
Bureaux  
Salles de Réunions  
Magasins  
Hopitaux  
Ecoles  
Couloirs

#### BODY

Anodized aluminum with satin finishing. Black and white color options with elegant design.

#### DIFFUSER

UV stabilized frosted diffuser.

#### CONVERTER

Long life, low power loss converter with constant current. Compatible with ENEC standards.

#### LED

LED modules with 60.000 hours lifetime LUMILEDS / SAMSUNG / NICHIA brand LEDs.

#### SUSPENSION

Composed of 1mm steel wire rope and nickel-plated brass components. Suspension height is adjustable. Supplied with transparent electric cord and ceiling mounted electrical junction box with aesthetic design

#### CORPS

Corps en aluminium anodisé, satiné. Design élégant. Couleurs blanc, noir disponibles.

#### DIFFUSEUR

Diffuseur givré. Anti UV.

#### CONVERTEUR

Convertisseur, conforme aux normes ENEC. Longue vie. Perte de puissance faible avec courant constant.

#### LED

Modules LED – Durée de vie 60.000 heures avec LED de marque LUMILEDS / SAMSUNG / NICHIA.

#### SYSTEME DE FIXATION

Composé d'un fil en acier de 1mm, de composants en laiton nickelés. Livré avec un cordon électrique transparent et une boîte de jonction électrique à fixer au plafond. Hauteur de fixation réglable.

Indirect Lighting  
Éclairage Indirect

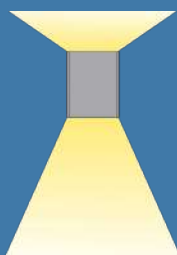

Direct Lighting  
Éclairage Direct

Color Options  
Options de Couleur



LED Type / Type LED

Color Rendering Index / Indice de Rendu des Couleurs: (CRI): Ra>80

Code	Power Puissance (W)	LED Type Type De LED	LED Module Module LED	Lum. Flux Flux Lum. (lm)	Color Temperature Température De Couleur (K)	Dimensions (mm)			Weight Poids (kg)	Packing Quantity Colisage	Pcs./20" Container Pcs./20" Conteneur
						a	l	h			
PL6S21L15C	21	2835 SMD	PCB	2140	2700 - 6500	104	628	48	1.3	5	1454
PL6S32L15C	33	2835 SMD	PCB	3565	2700 - 6500	104	908	48	1.7	5	1454
PL6S43L15C	47	2835 SMD	PCB	4990	2700 - 6500	104	1189	48	2.1	5	1134
PL6S54L15C	60	2835 SMD	PCB	6415	2700 - 6500	104	1469	48	2.5	5	920

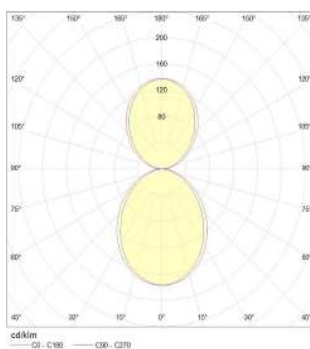
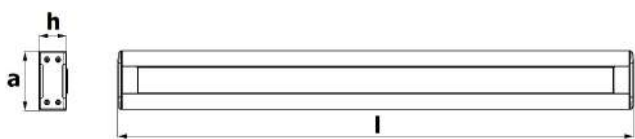

V / Hz 220 - 240 / 50 - 60

Options	Options
Dimmable electronic ballast or convertor. Emergency kit	Ballast électronique dimmable ou converteur. Kit d'urgence.
NOTE	NOTE
Given lumen values are net delivered luminaire output lumens.	Les valeurs de lumens données sont les lumens de sortie nets du luminaire.
Given power values are total consumed AC power of the luminaire.	Les valeurs de puissance données sont la puissance AC totale consommée du luminaire.





## APLIK / APPLIQUE

### LED

#### Applique Lighting Fixtures With Frosted Diffuser

#### Luminaire Applique Avec Diffuseur Givré

#### APPLICATION AREAS

Shopping Malls  
Supermarkets  
Offices  
Meeting rooms  
Stores  
Hospitals  
Schools  
Corridors

#### DOMAINES D'UTILISATION

Centres Commerciaux  
Supermarchés  
Bureaux  
Salles de Réunions  
Magasins  
Hopitaux  
Ecoles  
Couloirs

#### BODY

Anodized aluminum with satin finishing. Black and white color options with elegant design.

#### DIFFUSER

UV stabilized frosted diffuser.

#### CONVERTER

Long life, low power loss converter with constant current. Compatible with ENEC standards.

#### LED

LED modules with 60.000 hours lifetime LUMILEDS / SAMSUNG / NICHIA brand LEDs.

#### CORPS

Corps en aluminium anodisé, satiné. Design élégant. Couleurs blanc, noir disponibles.

#### DIFFUSEUR

Diffuseur givré. Anti UV.

#### CONVERTEUR

Convertisseur, conforme aux normes ENEC. Longue vie. Perte de puissance faible avec courant constant.

#### LED

Modules LED – Durée de vie 60.000 heures avec LED de marque LUMILEDS / SAMSUNG / NICHIA.

Indirect Lighting  
Éclairage Indirect

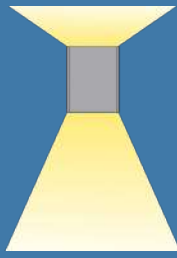

Direct Lighting  
Éclairage Direct



Color Options  
Options de Couleur



## LED Type / Type LED

Color Rendering Index / Indice de Rendu des Couleurs: (CRI): Ra>80

Code	Power Puissance (W)	LED Type Type De LED	LED Module Module LED	Lum. Flux Flux Lum. (lm)	Color Temperature Température De Couleur (K)	Dimensions (mm)			Weight Poids (kg)	Packing Quantity Colisage	Pcs./20" Container Pcs./20" Conteneur
						a	b	h			
PL6U21L15C	14	2835 SMD	PCB	1425	2700 - 6500	104	347	48	0.9	5	1454
PL6U22L15C	26	2835 SMD	PCB	2850	2700 - 6500	104	628	48	1.5	5	1454
PL6U23L15C	39	2835 SMD	PCB	4275	2700 - 6500	104	908	48	2.2	5	1454
PL6U24L15C	53	2835 SMD	PCB	5700	2700 - 6500	104	1189	48	2.9	5	1134

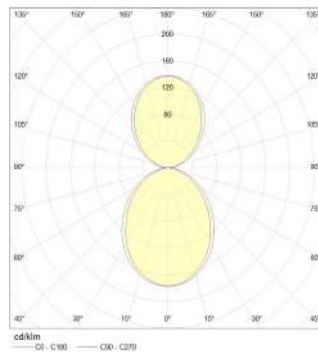
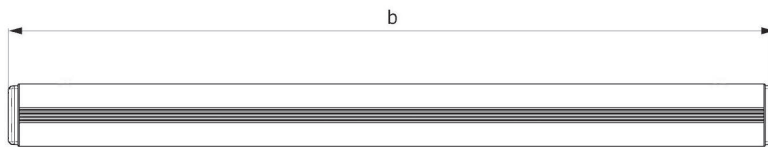
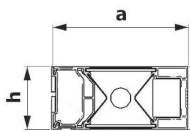

V / Hz | 220 - 240 / 50 - 60

Options	Options
Dimmable electronic ballast or convertor. Emergency kit	Ballast électronique dimmable ou converteur. Kit d'urgence.
NOTE	NOTE
Given lumen values are net delivered luminaire output lumens.	Les valeurs de lumens données sont les lumens de sortie nets du luminaire.
Given power values are total consumed AC power of the luminaire.	Les valeurs de puissance données sont la puissance AC totale consommée du luminaire.



 **pamir**<sup>®</sup>  
aydınlatma



**SIMETRI SLIM**

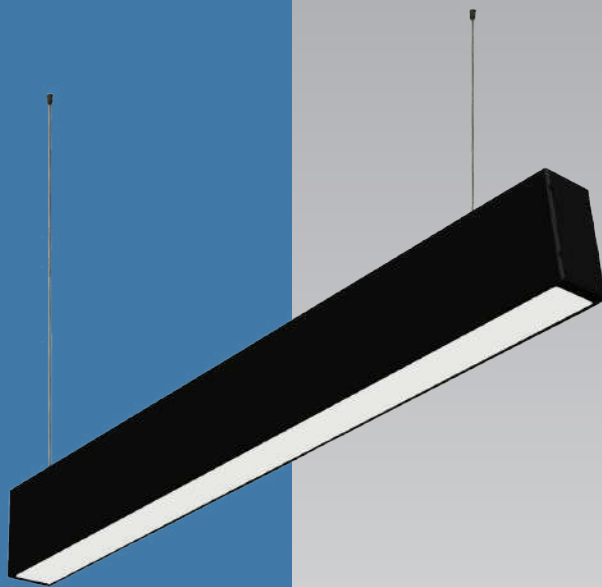

# SIMETRI SLIM DIRECT / INDIRECT

## LED

### Suspended Lighting Fixtures With Frosted Diffuser

### Luminaire suspendus Avec Diffuseur Givré

#### APPLICATION AREAS

Shopping Malls  
Supermarkets  
Offices  
Meeting rooms  
Stores  
Hospitals  
Schools  
Corridors

#### DOMAINES D'UTILISATION

Centres Commerciaux  
Supermarchés  
Bureaux  
Salles de Réunions  
Magasins  
Hopitaux  
Ecoles  
Couloirs

#### BODY

Anodized aluminum with satin finishing. Black and white color options with elegant design.

#### DIFFUSER

UV stabilized frosted diffuser.

#### CONVERTER

Long life, low power loss converter with constant current. Compatible with ENEC standards.

#### LED

LED modules with 60.000 hours lifetime LUMILEDS / SAMSUNG / NICHIA brand LEDs.

#### SUSPENSION

Composed of 1mm steel wire rope and nickel-plated brass components. Suspension height is adjustable. Supplied with transparent electric cord and ceiling mounted electrical junction box with aesthetic design

#### CORPS

Corps en aluminium anodisé, satiné. Design élégant. Couleurs blanc, noir disponibles.

#### DIFFUSEUR

Diffuseur givré. Anti UV.

#### CONVERTEUR

Convertisseur, conforme aux normes ENEC. Longue vie. Perte de puissance faible avec courant constant .

#### LED

Modules LED – Durée de vie 60.000 heures avec LED de marque LUMILEDS / SAMSUNG / NICHIA.

#### SYSTEME DE FIXATION

Composé d'un fil en acier de 1mm , de composants en laiton nickelés. Livré avec un cordon électrique transparent et une boîte de jonction électrique à fixer au plafond. Hauteur de fixation réglable.

Indirect Lighting  
Éclairage Indirect

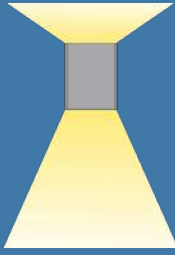

Direct Lighting  
Éclairage Direct

Color Options  
Options de Couleur



LED Type / Type LED

Color Rendering Index / Indice de Rendu des Couleurs: (CRI): Ra > 80

Code	Power Puissance (W)	LED Type Type De LED	LED Module Module LED	Lum. Flux Flux Lum. (lm)	Color Temperature Température De Couleur (K)	Dimensions (mm)			Weight Poids (kg)	Packing Quantity Colisage	Pcs./20" Container Pcs./20" Conteneur
						a	l	h			
PL21ES21L15C	14/8	2835 SMD	PCB	1290/665	2700 - 6500	40	570	76	1.4	6	4362
PL21ES32L15C	21/14	2835 SMD	PCB	1940/1330	2700 - 6500	40	850	76	1.8	6	4362
PL21ES43L15C	26/21	2835 SMD	PCB	2585/1995	2700 - 6500	40	1130	76	2.3	6	3402
PL21ES54L15C	33/26	2835 SMD	PCB	3230/2660	2700 - 6500	40	1410	76	2.8	6	2754
PL21ES65L15C	39/33	2835 SMD	PCB	3875/3325	2700 - 6500	40	1693	76	3.3	6	2364
PL21ES76L15C	47/39	2835 SMD	PCB	4520/3990	2700 - 6500	40	1973	76	3.8	6	1872
PL21ES87L15C	53/47	2835 SMD	PCB	5170/4655	2700 - 6500	40	2254	76	4.3	6	1872
PL21ES98L15C	60/53	2835 SMD	PCB	5815/5320	2700 - 6500	40	2534	76	4.8	6	1506
PL21ES109L15C	66/60	2835 SMD	PCB	6460/5985	2700 - 6500	40	2815	76	5.3	6	1506

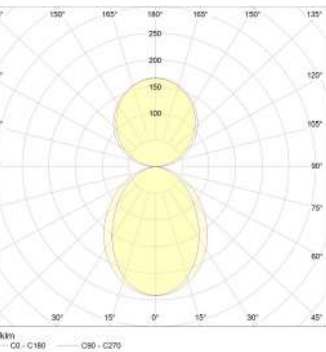
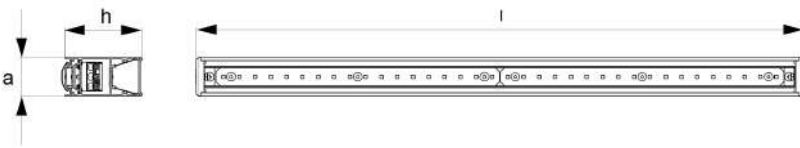

NOTE	NOTE
Given lumen values are net delivered luminaire output lumens.	Les valeurs de lumens données sont les lumens de sortie nets du luminaire.
Given power values are total consumed AC power of the luminaire.	Les valeurs de puissance données sont la puissance AC totale consommée du luminaire.

V / Hz 220 - 240 / 50 - 60

Options	Options
Dimmable electronic ballast or convertor.	Ballast électronique dimmable ou converteur.
Emergency kit	Kit d'urgence.
Magnet cap without screw.	Capuchon magnétique sans vis.



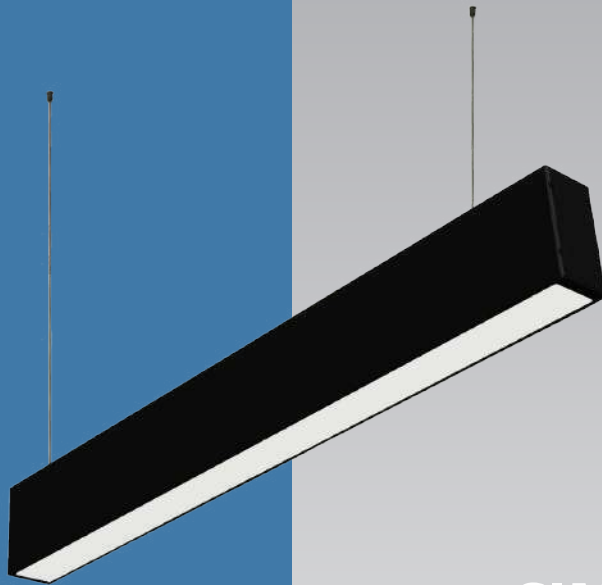

# SIMETRI SLIM DIRECT

## LED

### Suspended Lighting Fixtures With Frosted Diffuser

### Luminaire Suspendus Avec Diffuseur Givré

#### APPLICATION AREAS

Shopping Malls  
Supermarkets  
Offices  
Meeting rooms  
Stores  
Hospitals  
Schools  
Corridors

#### DOMAINES D'UTILISATION

Centres Commerciaux  
Supermarchés  
Bureaux  
Salles de Réunions  
Magasins  
Hopitaux  
Ecoles  
Couloirs

#### BODY

Anodized aluminum with satin finishing. Black and white color options with elegant design.

#### DIFFUSER

UV stabilized frosted diffuser.

#### CONVERTER

Long life, low power loss converter with constant current. Compatible with ENEC standards.

#### LED

LED modules with 60.000 hours lifetime LUMILEDS / SAMSUNG / NICHIA brand LEDs.

#### SUSPENSION

Composed of 1mm steel wire rope and nickel-plated brass components. Suspension height is adjustable. Supplied with transparent electric cord and ceiling mounted electrical junction box with aesthetic design

#### CORPS

Corps en aluminium anodisé, satiné. Design élégant. Couleurs blanc, noir disponibles.

#### DIFFUSEUR

Diffuseur givré. Anti UV.

#### CONVERTEUR

Convertisseur, conforme aux normes ENEC. Longue vie. Perte de puissance faible avec courant constant.

#### LED

Modules LED – Durée de vie 60.000 heures avec LED de marque LUMILEDS / SAMSUNG / NICHIA.

#### SYSTEME DE FIXATION

Composé d'un fil en acier de 1mm, de composants en laiton nickelés. Livré avec un cordon électrique transparent et une boîte de jonction électrique à fixer au plafond. Hauteur de fixation réglable.

Color Options  
Options de Couleur



LED Type / Type LED

Color Rendering Index / Indice de Rendu des Couleurs: (CRI): Ra>80

Code	Power Puissance (W)	LED Type Type De LED	LED Module Module LED	Lum. Flux Flux Lum. (lm)	Color Temperature Température De Couleur (K)	Dimensions (mm)			Weight Poids (kg)	Packing Quantity Colisage	Pcs./20" Container Pcs./20" Conteneur
						a	l	h			
PL21S12L15C	14	2835 SMD	PCB	1290	2700 - 6500	40	570	76	1.3	6	4362
PL21S13L15C	21	2835 SMD	PCB	1940	2700 - 6500	40	850	76	1.7	6	4362
PL21S14L15C	26	2835 SMD	PCB	2585	2700 - 6500	40	1130	76	2.2	6	3402
PL21S15L15C	33	2835 SMD	PCB	3230	2700 - 6500	40	1410	76	2.7	6	2754
PL21S16L15C	39	2835 SMD	PCB	3875	2700 - 6500	40	1693	76	3.3	6	2364
PL21S17L15C	47	2835 SMD	PCB	4520	2700 - 6500	40	1973	76	3.9	6	1872
PL21S18L15C	53	2835 SMD	PCB	5170	2700 - 6500	40	2254	76	4.2	6	1872
PL21S19L15C	60	2835 SMD	PCB	5815	2700 - 6500	40	2534	76	4.9	6	1506
PL21S10L15C	66	2835 SMD	PCB	6460	2700 - 6500	40	2815	76	5.4	6	1506

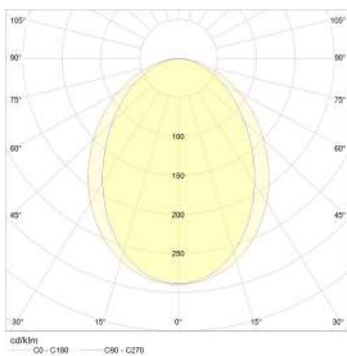
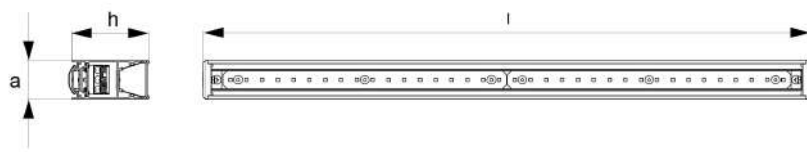

NOTE

Given lumen values are net delivered luminaire output lumens.

Given power values are total consumed AC power of the luminaire.

NOTE

Les valeurs de lumens données sont les lumens de sortie nets du luminaire.

Les valeurs de puissance données sont la puissance AC totale consommée du luminaire.

V / Hz    220 - 240 / 50 - 60

Options	Options
Dimmable electronic ballast or convertor.	Ballast électronique dimmable ou converteur.
Emergency kit	Kit d'urgence.
Magnet cap without screw.	Capuchon magnétique sans vis.





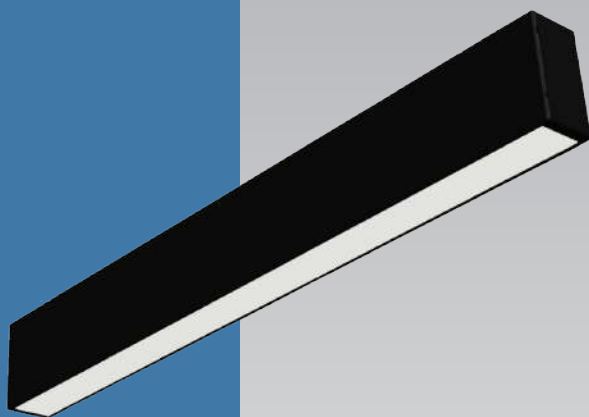

# SIMETRI SLIM DIRECT

## LED

### Surface Mounted Lighting Fixtures With Frosted Diffuser

### Luminaire Apparents Avec Diffuseur Givré

#### APPLICATION AREAS

Shopping Malls  
Supermarkets  
Offices  
Meeting rooms  
Stores  
Hospitals  
Schools  
Corridors

#### DOMAINES D'UTILISATION

Centres Commerciaux  
Supermarchés  
Bureaux  
Salles de Réunions  
Magasins  
Hopitaux  
Ecoles  
Couloirs

#### BODY

Anodized aluminum with satin finishing. Black and white color options with elegant design.

#### DIFFUSER

UV stabilized frosted diffuser.

#### CONVERTER

Long life, low power loss converter with constant current. Compatible with ENEC standards.

#### LED

LED modules with 60.000 hours lifetime LUMILEDS / SAMSUNG / NICHIA brand LEDs.

#### CORPS

Corps en aluminium anodisé, satiné. Design élégant. Couleurs blanc, noir disponibles.

#### DIFFUSEUR

Diffuseur givré. Anti UV.

#### CONVERTEUR

Convertisseur, conforme aux normes ENEC. Longue vie. Perte de puissance faible avec courant constant.

#### LED

Modules LED – Durée de vie 60.000 heures avec LED de marque LUMILEDS / SAMSUNG / NICHIA.

Color Options  
Options de Couleur



LED Type / Type LED

Color Rendering Index / Indice de Rendu des Couleurs: (CRI): Ra>80

Code	Power Puissance (W)	LED Type Type De LED	LED Module Module LED	Lum. Flux Flux Lum. (lm)	Color Temperature Température De Couleur (K)	Dimensions (mm)			Weight Poids (kg)	Packing Quantity Colisage	Pcs./20" Container Pcs./20" Conteneur
						a	l	h			
PL21U12L15C	14	2835 SMD	PCB	1290	2700 - 6500	40	570	76	1.3	6	4362
PL21U13L15C	21	2835 SMD	PCB	1940	2700 - 6500	40	850	76	1.7	6	4362
PL21U14L15C	26	2835 SMD	PCB	2585	2700 - 6500	40	1130	76	2.2	6	3402
PL21U15L15C	33	2835 SMD	PCB	3230	2700 - 6500	40	1410	76	2.7	6	2754
PL21U16L15C	39	2835 SMD	PCB	3875	2700 - 6500	40	1693	76	3.3	6	2364
PL21U17L15C	47	2835 SMD	PCB	4520	2700 - 6500	40	1973	76	3.9	6	1872
PL21U18L15C	53	2835 SMD	PCB	5170	2700 - 6500	40	2254	76	4.2	6	1872
PL21U19L15C	60	2835 SMD	PCB	5815	2700 - 6500	40	2534	76	4.9	6	1506
PL21U10L15C	66	2835 SMD	PCB	6460	2700 - 6500	40	2815	76	5.4	6	1506

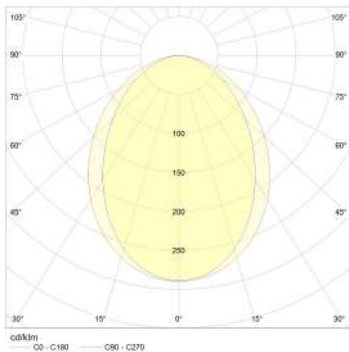
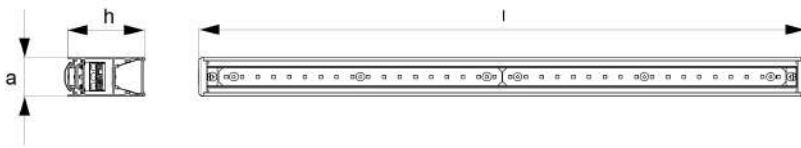

NOTE

Given lumen values are net delivered luminaire output lumens.

Given power values are total consumed AC power of the luminaire.

NOTE

Les valeurs de lumens données sont les lumens de sortie nets du luminaire.

Les valeurs de puissance données sont la puissance AC totale consommée du luminaire.

V / Hz 220 - 240 / 50 - 60

Options	Options
Dimmable electronic ballast or convertor.	Ballast électronique dimmable ou converteur.
Emergency kit	Kit d'urgence.
Magnet cap without screw.	Capuchon magnétique sans vis.





 **pamir**<sup>®</sup>  
lighting



**FLEKSI**

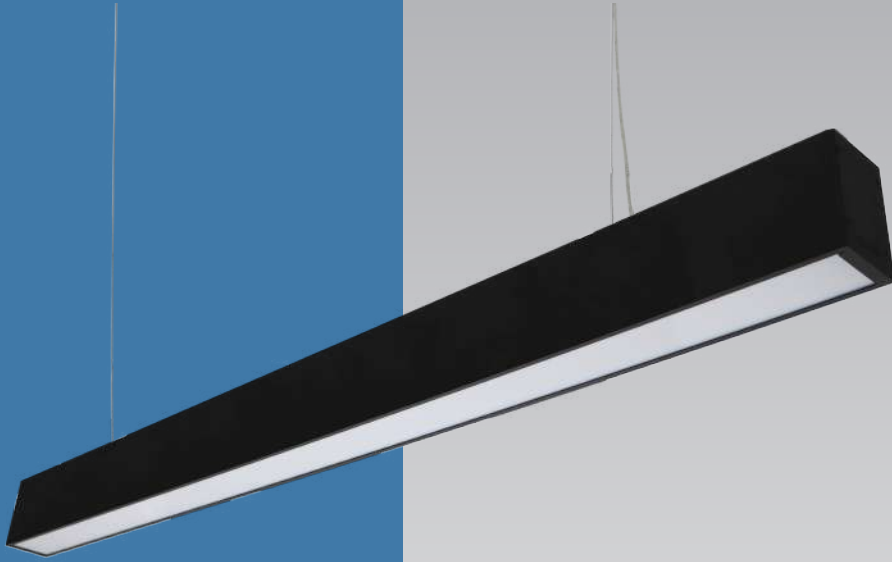

## FLEKSI

### LED

#### Suspended Lighting Fixtures With Frosted Diffuser

#### Luminaires Suspendus Avec Diffuseur Givré

#### APPLICATION AREAS

Shopping Malls  
Supermarkets  
Offices  
Meeting rooms  
Stores  
Hospitals  
Schools  
Corridors

#### DOMAINES D'UTILISATION

Centres Commerciaux  
Supermarchés  
Bureaux  
Salles de Réunions  
Magasins  
Hopitaux  
Ecoles  
Couloirs

#### BODY

Anodized aluminum with satin finishing. Black and white color options with elegant design.

#### DIFFUSER

UV stabilized frosted diffuser.

#### CONVERTER

Long life, low power loss converter with constant current. Compatible with ENEC standards.

#### LED

LED modules with 60.000 hours lifetime LUMILEDS / SAMSUNG / NICHIA brand LEDs.

#### SUSPENSION

Composed of 1mm steel wire rope and nickel-plated brass components. Suspension height is adjustable. Supplied with transparent electric cord and ceiling mounted electrical junction box with aesthetic design

#### CORPS

Corps en aluminium anodisé, satiné. Design élégant. Couleurs blanc, noir disponibles.

#### DIFFUSEUR

Diffuseur givré. Anti UV.

#### CONVERTEUR

Convertisseur, conforme aux normes ENEC. Longue vie. Perte de puissance faible avec courant constant .

#### LED

Modules LED – Durée de vie 60.000 heures avec LED de marque LUMILEDS / SAMSUNG / NICHIA.

#### SYSTEME DE FIXATION

Composé d'un fil en acier de 1mm , de composants en laiton nickelés. Livré avec un cordon électrique transparent et une boîte de jonction électrique à fixer au plafond. Hauteur de fixation réglable.

Color Options  
Options de Couleur

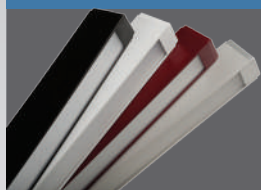

LED Type / Type LED

Color Rendering Index / Indice de Rendu des Couleurs: (CRI): Ra>80

Code	Power Puissance (W)	LED Type Type De LED	LED Module Module LED	Lum. Flux Flux Lum. (lm)	Color Temperature Température De Couleur (K)	Dimensions (mm)			Weight Poids (kg)	Packing Quantity Colisage	Pcs./20" Container Pcs./20" Conteneur
						a	b	h			
PL3S12L15C	14	2835 SMD	PCB	1200	2700 - 6500	57	570	85	1.9	2	1454
PL3S12L25C	21	2835 SMD	PCB	1805	2700 - 6500	57	570	85	1.9	2	1454
PL3S13L15C	21	2835 SMD	PCB	1795	2700 - 6500	57	850	85	2.2	2	1454
PL3S13L25C	30	2835 SMD	PCB	2705	2700 - 6500	57	850	85	2.2	2	1454
PL3S14L15C	26	2835 SMD	PCB	2395	2700 - 6500	57	1130	85	2.7	2	1134
PL3S14L25C	41	2835 SMD	PCB	3605	2700 - 6500	57	1130	85	2.7	2	1134
PL3S15L15C	33	2835 SMD	PCB	2995	2700 - 6500	57	1412	85	3.2	2	918
PL3S15L25C	51	2835 SMD	PCB	4505	2700 - 6500	57	1412	85	3.2	2	918
PL3S16L15C	39	2835 SMD	PCB	3595	2700 - 6500	57	1693	85	3.7	2	788
PL3S16L25C	61	2835 SMD	PCB	5405	2700 - 6500	57	1693	85	3.7	2	788
PL3S17L15C	47	2835 SMD	PCB	4190	2700 - 6500	57	1973	85	4.2	2	624
PL3S17L25C	70	2835 SMD	PCB	6310	2700 - 6500	57	1973	85	4.2	2	624
PL3S18L15C	53	2835 SMD	PCB	4790	2700 - 6500	57	2254	85	4.7	2	624
PL3S19L15C	60	2835 SMD	PCB	5390	2700 - 6500	57	2534	85	5.2	2	520
PL3S10L15C	66	2835 SMD	PCB	5985	2700 - 6500	57	2815	85	5.7	2	520

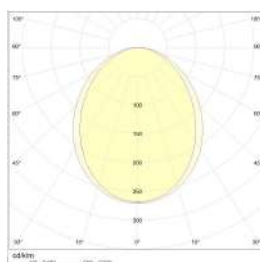
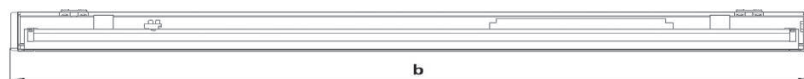

V / Hz 220 - 240 / 50 - 60

Options	Options
Dimmable electronic ballast or convertor. Emergency kit	Ballast électronique dimmable ou converteur. Kit d'urgence.
NOTE	NOTE
Given lumen values are net delivered luminaire output lumens.	Les valeurs de lumens données sont les lumens de sortie nets du luminaire.
Given power values are total consumed AC power of the luminaire.	Les valeurs de puissance données sont la puissance AC totale consommée du luminaire.

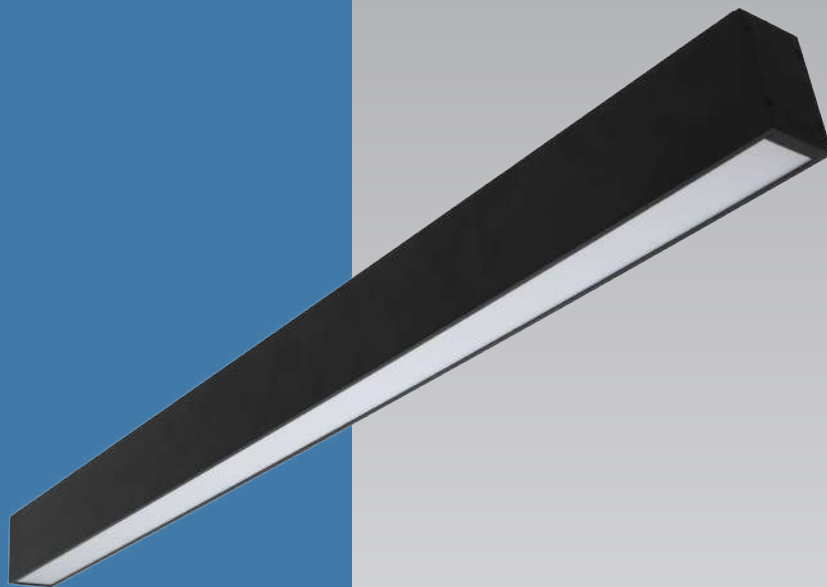

## FLEKSI

### LED

#### Surface Mounted Lighting Fixtures With Frosted Diffuser

#### Luminaire Apparents Avec Diffuseur Givré

#### APPLICATION AREAS

Shopping Malls  
Supermarkets  
Offices  
Meeting rooms  
Stores  
Hospitals  
Schools  
Corridors

#### DOMAINES D'UTILISATION

Centres Commerciaux  
Supermarchés  
Bureaux  
Salles de Réunions  
Magasins  
Hopitaux  
Ecoles  
Couloirs

#### BODY

Anodized aluminum with satin finishing. Black and white color options with elegant design.

#### DIFFUSER

UV stabilized frosted diffuser.

#### CONVERTER

Long life, low power loss converter with constant current. Compatible with ENEC standards.

#### LED

LED modules with 60.000 hours lifetime LUMILEDS / SAMSUNG / NICHIA brand LEDs.

#### CORPS

Corps en aluminium anodisé, satiné. Design élégant. Couleurs blanc, noir disponibles.

#### DIFFUSEUR

Diffuseur givré. Anti UV.

#### CONVERTEUR

Convertisseur, conforme aux normes ENEC. Longue vie. Perte de puissance faible avec courant constant.

#### LED

Modules LED – Durée de vie 60.000 heures avec LED de marque LUMILEDS / SAMSUNG / NICHIA.

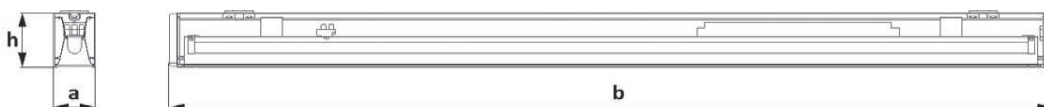

Color Options  
Options de Couleur

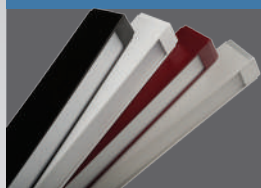

LED Type / Type LED

Color Rendering Index / Indice de Rendu des Couleurs: (CRI): Ra>80

Code	Power Puissance (W)	LED Type Type De LED	LED Module Module LED	Lum. Flux Flux Lum. (lm)	Color Temperature Température De Couleur (K)	Dimensions (mm)			Weight Poids (kg)	Packing Quantity Colisage	Pcs./20" Container Pcs./20" Conteneur
						a	b	h			
PL3U12L15C	14	2835 SMD	PCB	1200	2700 - 6500	57	570	85	1,9	2	2930
PL3U12L25C	21	2835 SMD	PCB	1805	2700 - 6500	57	570	85	1,9	2	2930
PL3U13L15C	21	2835 SMD	PCB	1795	2700 - 6500	57	850	85	2,3	2	2010
PL3U13L25C	30	2835 SMD	PCB	2705	2700 - 6500	57	850	85	2,3	2	2010
PL3U14L15C	26	2835 SMD	PCB	2395	2700 - 6500	57	1130	85	2,9	2	2270
PL3U14L25C	41	2835 SMD	PCB	3605	2700 - 6500	57	1130	85	2,9	2	2270
PL3U15L15C	33	2835 SMD	PCB	2995	2700 - 6500	57	1412	85	3,5	2	1835
PL3U15L15CSB	33	2835 SMD	PCB	2995	2700 - 6500	57	1408	85	3,5	2	1835
PL3U15L15CS0	33	2835 SMD	PCB	2995	2700 - 6500	57	1404	85	3,5	2	1835
PL3U15L25C	51	2835 SMD	PCB	4505	2700 - 6500	57	1412	85	3,5	2	1835
PL3U15L25CSB	51	2835 SMD	PCB	4505	2700 - 6500	57	1408	85	3,5	2	1835
PL3U15L25CS0	51	2835 SMD	PCB	4505	2700 - 6500	57	1404	85	3,5	2	1835
PL3U16L15C	39	2835 SMD	PCB	3595	2700 - 6500	57	1693	85	4,1	2	1575
PL3U16L15CSB	39	2835 SMD	PCB	3595	2700 - 6500	57	1689	85	4,1	2	1575
PL3U16L15CS0	39	2835 SMD	PCB	3595	2700 - 6500	57	1685	85	4,1	2	1575
PL3U16L25C	61	2835 SMD	PCB	5405	2700 - 6500	57	1693	85	4,1	2	1575
PL3U16L25CSB	61	2835 SMD	PCB	5405	2700 - 6500	57	1689	85	4,1	2	1575
PL3U16L25CS0	61	2835 SMD	PCB	5405	2700 - 6500	57	1685	85	4,1	2	1575
PL3U17L15C	47	2835 SMD	PCB	4190	2700 - 6500	57	1973	85	4,7	2	1250
PL3U17L15CSB	47	2835 SMD	PCB	4190	2700 - 6500	57	1969	85	4,7	2	1250
PL3U17L15CS0	47	2835 SMD	PCB	4190	2700 - 6500	57	1965	85	4,7	2	1250
PL3U17L25C	70	2835 SMD	PCB	6310	2700 - 6500	57	1973	85	4,7	2	1250
PL3U17L25CSB	70	2835 SMD	PCB	6310	2700 - 6500	57	1969	85	4,7	2	1250
PL3U17L25CS0	70	2835 SMD	PCB	6310	2700 - 6500	57	1965	85	4,7	2	1250
PL3U18L15C	53	2835 SMD	PCB	4790	2700 - 6500	57	2254	85	5,3	2	1250
PL3U18L15CSB	53	2835 SMD	PCB	4790	2700 - 6500	57	2250	85	5,3	2	1250
PL3U18L15CS0	53	2835 SMD	PCB	4790	2700 - 6500	57	2246	85	5,3	2	1250
PL3U19L15C	60	2835 SMD	PCB	5390	2700 - 6500	57	2534	85	5,9	2	1250
PL3U19L15CSB	60	2835 SMD	PCB	5390	2700 - 6500	57	2530	85	5,9	2	1250
PL3U19L15CS0	60	2835 SMD	PCB	5390	2700 - 6500	57	2526	85	5,9	2	1250
PL3U10L15C	66	2835 SMD	PCB	5985	2700 - 6500	57	2815	85	6,5	2	1000
PL3U10L15CSB	66	2835 SMD	PCB	5985	2700 - 6500	57	2811	85	6,5	2	1000
PL3U10L15CS0	66	2835 SMD	PCB	5985	2700 - 6500	57	2807	85	6,5	2	1000

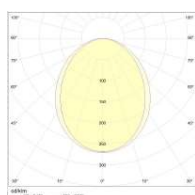

V / Hz 220 - 240 / 50 - 60

Options	Options
Dimmable electronic ballast or convertor.	Ballast électronique dimmable ou converteur.
Emergency kit	Kit d'urgence.

NOTE	NOTE
Given lumen values are net delivered luminaire output lumens.	Les valeurs de lumens données sont les lumens de sortie nets du luminaire.
Given power values are total consumed AC power of the luminaire.	Les valeurs de puissance données sont la puissance AC totale consommée du luminaire.





 **pamir**<sup>®</sup>  
lighting





**ELEGANT**



## ELEGANT

### LED

#### Suspended 1X Lighting Fixtures With Frosted Diffuser

#### Luminaire Suspendu 1X Avec Diffuseur Givré

#### APPLICATION AREAS

Offices  
Meeting rooms  
Stores  
Hospitals  
Schools  
Corridors

#### DOMAINES D'UTILISATION

Bureaux  
Salles de Réunion  
Magasins  
Hopitaux  
Ecoles  
Couloirs

#### BODY

Anodized aluminum with satin finishing. Bronze, silver and white color options with thin (37mm) elegant design.

#### DIFFUSER

UV stabilized frosted diffuser.

#### CONVERTER

Long life, low power loss converter with constant current. Compatible with ENEC standards.

#### LED

LED modules with 60.000 hours lifetime LUMILEDS / SAMSUNG / NICHIA brand LEDs.

#### SUSPENSION

Composed of 1mm steel wire rope and nickel-plated brass components. Suspension height is adjustable. Supplied with transparent electric cord and ceiling mounted electrical junction box with aesthetic design.

#### CORPS

Corps en aluminium anodisé, satiné. Design élégant. Couleurs argent, bronze et blanc disponibles. Epaisseur 37 mm.

#### DIFFUSEUR

Diffuseur givré. Anti UV.

#### CONVERTEUR

Convertisseur, conforme aux normes ENEC. Longue vie. Perte de puissance faible avec courant constant.

#### LED

Modules LED – Durée de vie 60.000 heures avec LED de marque LUMILEDS / SAMSUNG / NICHIA.

#### SYSTEME DE FIXATION

Composé d'un fil en acier de 1mm, de composants en laiton nickelés. Livré avec un cordon électrique transparent et une boîte de jonction électrique à fixer au plafond. Hauteur de fixation réglable.

**Color Options  
Options de Couleur**

White  
Blanc  
Silver  
Argent  
Bronz  
Bronze



**LED Type / Type LED**

**Color Rendering Index / Indice de Rendu des Couleurs: (CRI): Ra>80**

Code	Power Puissance (W)	LED Type Type De LED	LED Module Module LED	Lum. Flux Flux Lum. (lm)	Color Temperature Température De Couleur (K)	Dimensions (mm)			Weight Poids (kg)	Packing Quantity Colisage	Pcs./20" Container Pcs./20" Conteneur
						a	b	h			
PL1S11L15C	8	2835 SMD	PCB	620	2700 - 6500	165	418	37	1.2	2	4414
PL1S12L15C	14	2835 SMD	PCB	1235	2700 - 6500	165	699	37	1.9	2	2766
PL1S13L15C	21	2835 SMD	PCB	1855	2700 - 6500	165	980	37	2.6	2	2014
PL1S14L15C	26	2835 SMD	PCB	2470	2700 - 6500	165	1260	37	3.4	2	1572
PL1S15L15C	33	2835 SMD	PCB	3090	2700 - 6500	165	1540	37	4.1	2	1296

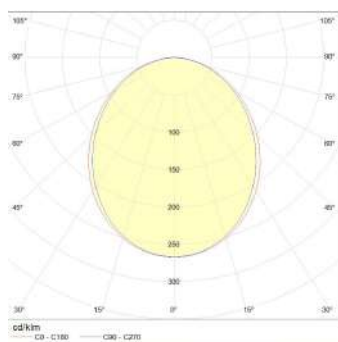
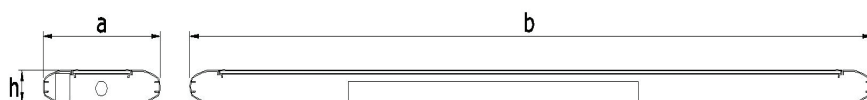

**V / Hz** 220 - 240 / 50 - 60

Options	Options
Dimmable electronic ballast or convertor.	Ballast électronique dimmable ou converteur.
Emergency kit	Kit d'urgence.

NOTE	NOTE
Given lumen values are net delivered luminaire output lumens.	Les valeurs de lumens données sont les lumens de sortie nets du luminaire.
Given power values are total consumed AC power of the luminaire.	Les valeurs de puissance données sont la puissance AC totale consommée du luminaire.



## ELEGANT

### LED

#### Suspended 2X Lighting Fixtures With Frosted Diffuser

#### Luminaire Suspendu 2X Avec Diffuseur Givré

##### BODY

Anodized aluminum with satin finishing. Bronze, silver and white color options with thin (37mm) elegant design.

##### DIFFUSER

UV stabilized frosted diffuser.

##### CONVERTER

Long life, low power loss converter with constant current. Compatible with ENEC standards.

##### LED

LED modules with 60.000 hours lifetime LUMILEDS / SAMSUNG / NICHIA brand LEDs.

##### SUSPENSION

Composed of 1mm steel wire rope and nickel-plated brass components. Suspension height is adjustable. Supplied with transparent electric cord and ceiling mounted electrical junction box with aesthetic design.

##### CORPS

Corps en aluminium anodisé, satiné. Design élégant. Couleurs argent, bronze et blanc disponibles. Epaisseur 37 mm.

##### DIFFUSEUR

Diffuseur givré. Anti UV.

##### CONVERTEUR

Convertisseur, conforme aux normes ENEC. Longue vie. Perte de puissance faible avec courant constant.

##### LED

Modules LED – Durée de vie 60.000 heures avec LED de marque LUMILEDS / SAMSUNG / NICHIA.

##### SYSTEME DE FIXATION

Composé d'un fil en acier de 1mm, de composants en laiton nickelés. Livré avec un cordon électrique transparent et une boîte de jonction électrique à fixer au plafond. Hauteur de fixation réglable.

#### APPLICATION AREAS

Offices  
Meeting rooms  
Stores  
Hospitals  
Schools  
Corridors

#### DOMAINES D'UTILISATION

Bureaux  
Salles de Réunion  
Magasins  
Hopitaux  
Ecoles  
Couloirs

**Color Options**  
**Options de Couleur**

White  
Blanc  
Silver  
Argent  
Bronz  
Bronze



**LED Type / Type LED**

**Color Rendering Index / Indice de Rendu des Couleurs: (CRI): Ra>80**

Code	Power Puissance (W)	LED Type Type De LED	LED Module Module LED	Lum. Flux Flux Lum. (lm)	Color Temperature Température De Couleur (K)	Dimensions (mm)			Weight Poids (kg)	Packing Quantity Colisage	Pcs./20" Container Pcs./20" Conteneur
						a	b	h			
PL1S21L15C	14	2835 SMD	PCB	1235	2700 - 6500	287	418	37	2.2	2	2856
PL1S22L15C	26	2835 SMD	PCB	2470	2700 - 6500	287	699	37	3.3	2	1790
PL1S23L15C	39	2835 SMD	PCB	3705	2700 - 6500	287	980	37	4.3	2	1300
PL1S24L15C	53	2835 SMD	PCB	4940	2700 - 6500	287	1260	37	5.4	2	1020
PL1S25L15C	66	2835 SMD	PCB	6175	2700 - 6500	287	1540	37	6.7	2	844

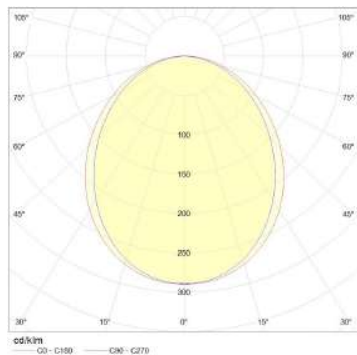
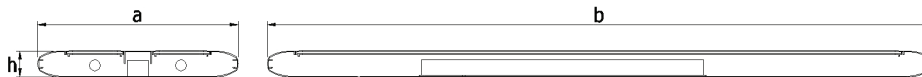

V / Hz | 220 - 240 / 50 - 60

Options	Options
Dimmable electronic ballast or convertor. Emergency kit	Ballast électronique dimmable ou convertor. Kit d'urgence.
NOTE	NOTE
Given lumen values are net delivered luminaire output lumens.	Les valeurs de lumens données sont les lumens de sortie nets du luminaire.
Given power values are total consumed AC power of the luminaire.	Les valeurs de puissance données sont la puissance AC totale consommée du luminaire.



## ELEGANT

### LED

#### Surface Mounted 4X Lighting Fixtures With Frosted Diffuser

#### Luminaire Apparents 4X Avec Diffuseur Givré

#### APPLICATION AREAS

Offices  
Meeting rooms  
Stores  
Hospitals  
Schools  
Corridors

#### DOMAINES D'UTILISATION

Bureaux  
Salles de Réunion  
Magasins  
Hopitaux  
Ecoles  
Couloirs

#### BODY

Anodized aluminum with satin finishing. Bronze, silver and white color options with thin (37mm) elegant design.

#### DIFFUSER

UV stabilized frosted diffuser.

#### CONVERTER

Long life, low power loss converter with constant current. Compatible with ENEC standards.

#### LED

LED modules with 60.000 hours lifetime LUMILEDS / SAMSUNG / NICHIA brand LEDs.

#### CORPS

Corps en aluminium anodisé, satiné. Design élégant. Couleurs argent, bronze et blanc disponibles. Epaisseur 37 mm.

#### DIFFUSEUR

Diffuseur givré. Anti UV.

#### CONVERTEUR

Convertisseur, conforme aux normes ENEC. Longue vie. Perte de puissance faible avec courant constant.

#### LED

Modules LED – Durée de vie 60.000 heures avec LED de marque LUMILEDS / SAMSUNG / NICHIA.

**Color Options**  
**Options de Couleur**

White  
Blanc  
Silver  
Argent  
Bronz  
Bronze



**LED Type / Type LED**

**Color Rendering Index / Indice de Rendu des Couleurs: (CRI): Ra>80**

Code	Power Puissance (W)	LED Type Type De LED	LED Module Module LED	Lum. Flux Flux Lum. (lm)	Color Temperature Température de Couleur (K)	Dimensions (mm)			Weight Poids (kg)	Packing Quantity Colisage	Pcs./20" Container Pcs./20" Conteneur
						a	b	h			
PL1U42L15C	53	2835 SMD	PCB	4940	2700 - 6500	486	692	37	5.2	2	1126
PL1U43L15C	79	2835 SMD	PCB	7410	2700 - 6500	486	973	37	7.0	2	820
PL1U44L15C	105	2835 SMD	PCB	9880	2700 - 6500	486	1254	37	8.7	2	644
PL1U45L15C	132	2835 SMD	PCB	12350	2700 - 6500	486	1535	37	10.5	2	530

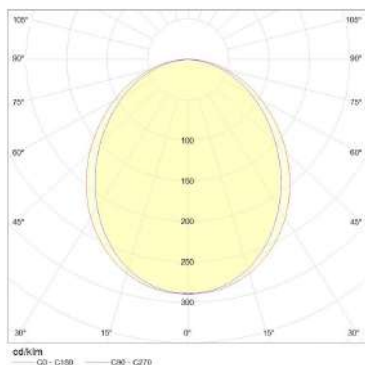

**V / Hz** 220 - 240 / 50 - 60

Options	Options
Dimmable electronic ballast or convertor. Emergency kit	Ballast électronique dimmable ou converteur. Kit d'urgence.

NOTE	NOTE
Given lumen values are net delivered luminaire output lumens.	Les valeurs de lumens données sont les lumens de sortie nets du luminaire.
Given power values are total consumed AC power of the luminaire.	Les valeurs de puissance données sont la puissance AC totale consommée du luminaire.





 **pamir**<sup>®</sup>  
aydınlıkta

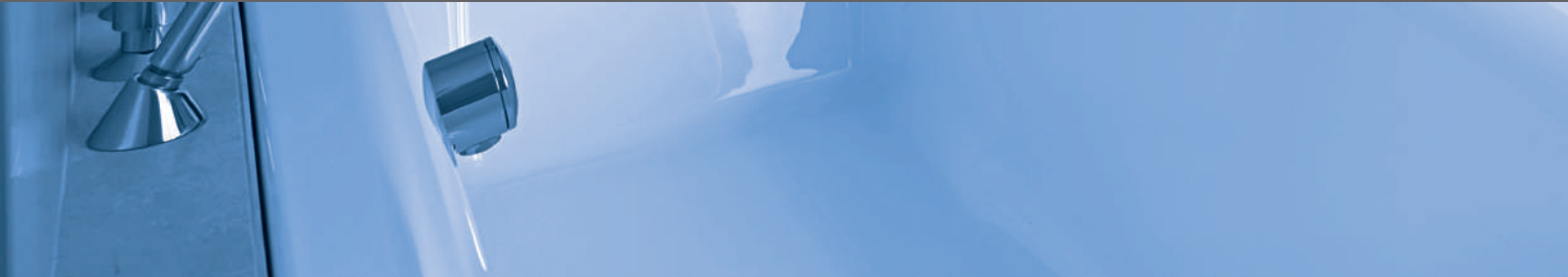



**APPLIQUE**



## APLIK / APPLIQUE

### LED

#### Mirror Type Applique Lighting Fixtures With Frosted Diffuser

#### Applique Pour Miroir Avec Diffuseur Givré

##### BODY

Anodized aluminum with satin finishing. Black, white and silver color options with elegant design.

##### DIFFUSER

UV stabilized frosted diffuser.

##### CONVERTER

Long life, low power loss converter with constant current. Compatible with ENEC standards.

##### LED

LED modules with 60.000 hours lifetime LUMILEDS / SAMSUNG / NICHIA brand LEDs.

##### APPLICATION AREAS

Washbasins  
Bathrooms  
Offices  
Meeting rooms  
Stores  
Hospitals  
Schools  
Corridors

##### DOMAINES D'UTILISATION

Lavabos  
Salles de Bain  
Bureaux  
Salles de Réunions  
Magasins  
Hopitaux  
Ecoles  
Couloirs

##### CORPS

Corps en aluminium anodisé, satiné. Design élégant. Couleurs blanc, argent, noir disponibles.

##### DIFFUSEUR

Diffuseur givré. Anti UV.

##### CONVERTEUR

Convertisseur, conforme aux normes ENEC. Longue vie. Perte de puissance faible avec courant constant.

##### LED

Modules LED – Durée de vie 60.000 heures avec LED de marque LUMILEDS / SAMSUNG / NICHIA.

Color Options  
Options de Couleur



LED Type / Type LED

Color Rendering Index / Indice de Rendu des Couleurs: (CRI): Ra>80

Code	Power Puissance (W)	LED Type Type De LED	LED Module Module LED	Lum. Flux Flux Lum. (lm)	Color Temperature Température De Couleur (K)	Dimensions (mm)			Weight Poids (kg)	Packing Quantity Colisage	Pcs./20" Container Pcs./20" Conteneur
						a	b	h			
PLSU11L15C	8	2835 SMD	PCB	675	2700 - 6500	104	340	60	1.3	2	5620
PLSU12L15C	14	2835 SMD	PCB	1350	2700 - 6500	104	620	60	1.7	2	3120
PLSU13L15C	21	2835 SMD	PCB	2025	2700 - 6500	104	900	60	2.0	2	1454
PLSU14L15C	26	2835 SMD	PCB	2700	2700 - 6500	104	1181	60	2.4	2	1134

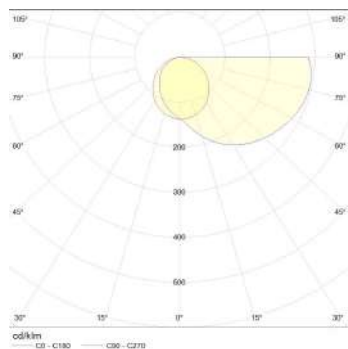

V / Hz 220 - 240 / 50 - 60

<b>Options</b> Dimmable electronic ballast or convertor. Emergency kit	<b>Options</b> Ballast électronique dimmable ou converteur. Kit d'urgence.
<b>NOTE</b> Given lumen values are net delivered luminaire output lumens.	<b>NOTE</b> Les valeurs de lumens données sont les lumens de sortie nets du luminaire.
<b>NOTE</b> Given power values are total consumed AC power of the luminaire.	<b>NOTE</b> Les valeurs de puissance données sont la puissance AC totale consommée du luminaire.



## APLIK / APPLIQUE

### LED

Kitchen Type Applique Lighting

Fixture With Frosted Diffuser

Applique Pour Cuisine Avec Diffuseur Givré

#### APPLICATION AREAS

Under Kitchen Cabinets  
Under Shelves  
Shopping Malls  
Supermarkets  
Offices  
Meeting rooms  
Stores  
Hospitals  
Schools  
Corridors

#### DOMAINES D'UTILISATION

Sous Placards de Cuisine  
Sous Etagérés  
Centres Commerciaux  
Supermarchés  
Bureaux  
Salles de Réunions  
Magasins  
Hopitaux  
Ecoles  
Coulloirs

#### BODY

Anodized aluminum with satin finishing. Black, white and silver color options with elegant design.

#### DIFFUSER

UV stabilized frosted diffuser.

#### CONVERTER

Long life, low power loss converter with constant current. Compatible with ENEC standards.

#### LED

LED modules with 60.000 hours lifetime LUMILEDS / SAMSUNG / NICHIA brand LEDs.

#### CORPS

Corps en aluminium anodisé, satiné. Design élégant. Couleurs blanc, argent, noir disponibles.

#### DIFFUSEUR

Diffuseur givré. Anti UV.

#### CONVERTEUR

Convertisseur, conforme aux normes ENEC. Longue vie. Perte de puissance faible avec courant constant.

#### LED

Modules LED – Durée de vie 60.000 heures avec LED de marque LUMILEDS / SAMSUNG / NICHIA.

Color Options  
Options de Couleur



LED Type / Type LED

Color Rendering Index / Indice de Rendu des Couleurs: (CRI): Ra>80

Code	Power Puissance (W)	LED Type Type De LED	LED Module Module LED	Lum. Flux Flux Lum. (lm)	Color Temperature Température De Couleur (K)	Dimensions (mm)			Weight Poids (kg)	Packing Quantity Colisage	Pcs./20" Container Pcs./20" Conteneur
						a	l	h			
PL9U11L15CP	8	2835 SMD	PCB	550	2700 - 6500	93	335	63	0,7	2	5890
PL9U12L15CP	14	2835 SMD	PCB	1105	2700 - 6500	93	616	63	1,8	2	3310
PL9U13L15CP	21	2835 SMD	PCB	1655	2700 - 6500	93	897	63	2,3	2	1454
PL9U14L15CP	26	2835 SMD	PCB	2205	2700 - 6500	93	1178	63	2,8	2	1134
PL9U15L15CP	33	2835 SMD	PCB	2755	2700 - 6500	93	1459	63	3,3	2	918

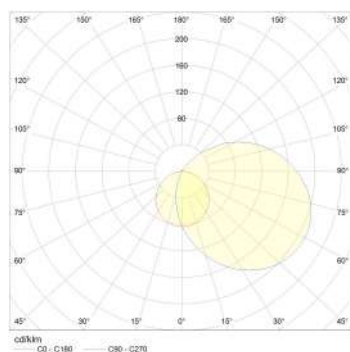
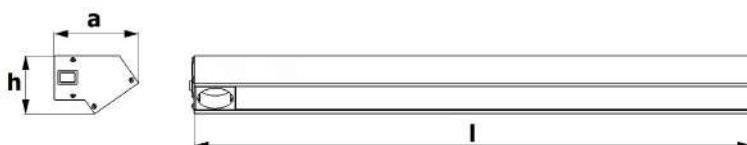

V / Hz 220 - 240 / 50 - 60

<b>Options</b> Dimmable electronic ballast or convertor. Emergency kit	<b>Options</b> Ballast électronique dimmable ou converteur. Kit d'urgence.
<b>NOTE</b> Given lumen values are net delivered luminaire output lumens. Given power values are total consumed AC power of the luminaire.	<b>NOTE</b> Les valeurs de lumens données sont les lumens de sortie nets du luminaire. Les valeurs de puissance données sont la puissance AC totale consommée du luminaire.

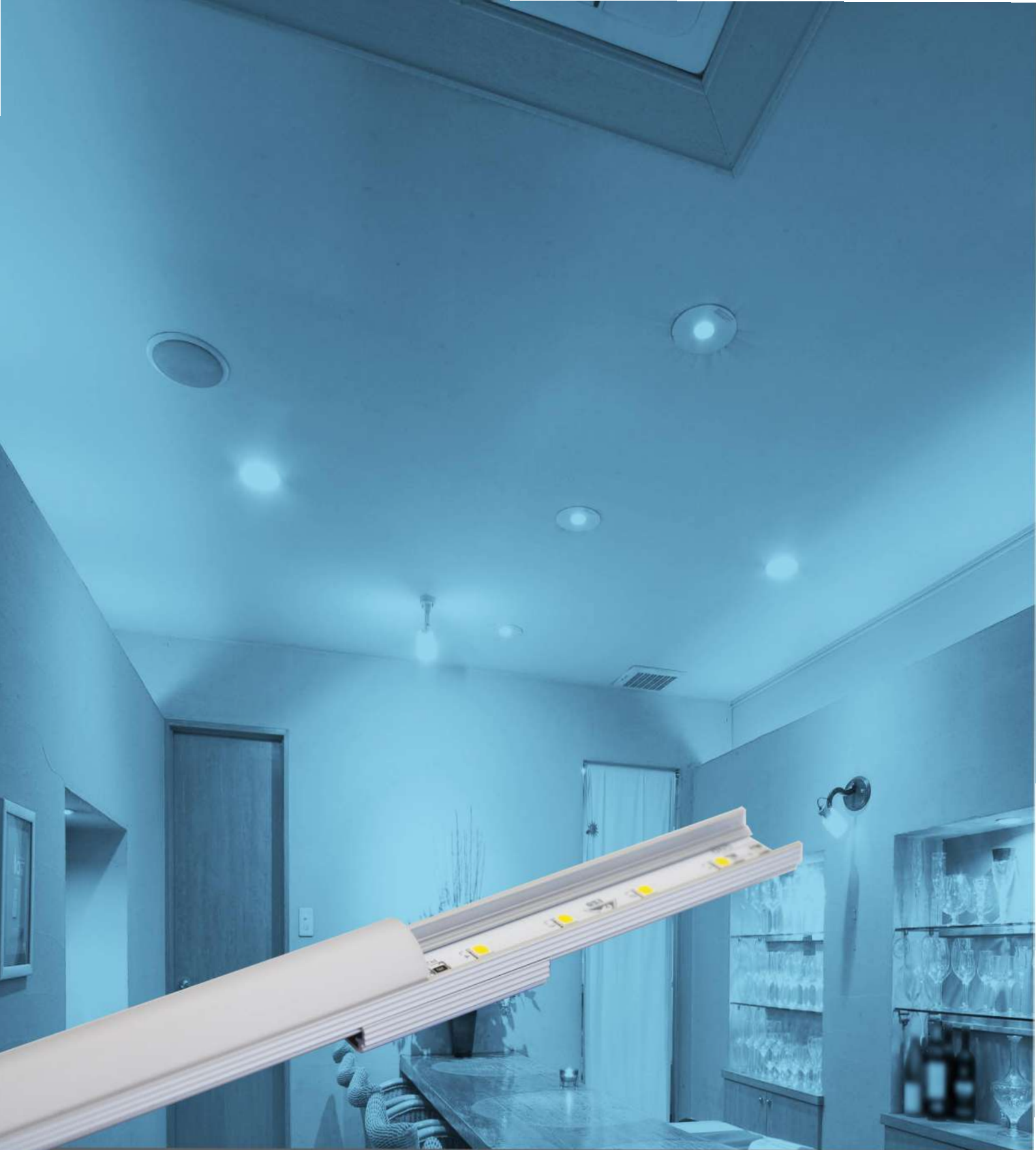

 **pamir**<sup>®</sup>  
aydınlatma





# COVE LIGHTING





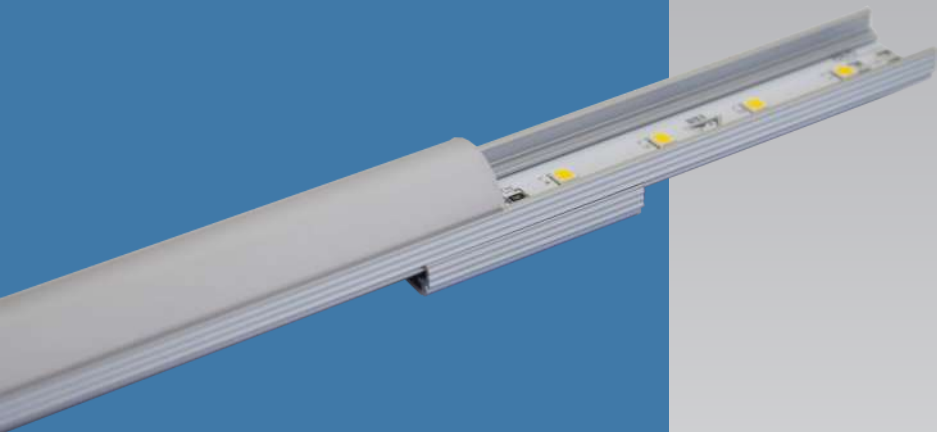

# COVE LIGHTING

## LED

Aluminum Profile Cove Lighting  
Fixtures With Diffuser

Appareils D'éclairage De Crique De  
Profil En Aluminium Avec Diffuseur

### APPLICATION AREAS

Under Kitchen Cabinets  
Under Shelves  
Shopping Malls  
Supermarkets  
Offices  
Meeting rooms  
Stores  
Hospitals  
Schools  
Corridors

### DOMAINES D'UTILISATION

Sous Placards de Cuisine  
Sous Etagères  
Centres Commerciaux  
Supermarchés  
Bureaux  
Salles de Réunions  
Magasins  
Hopitaux  
Ecoles  
Couloirs

#### BODY

Matt natural anodized, aluminum extrusion profile. With mounting accessories and plastic end cap.

#### DIFFUSER

UV stabilized frosted diffuser.

#### LED

24V constant voltage LED modules with 60.000 hours lifetime SEOUL brand LEDs.

#### CORPS

Profilé d'extrusion en aluminium anodisé naturel mat. Avec accessoires de montage et embout en plastique.

#### DIFFUSEUR

Diffuseur givré. Anti UV.

#### LED

Modules LED 24V tension constante – Durée de vie 60.000 heures avec LED de marque SEOUL.

Color Options  
Options de Couleur



LED Type / Type LED

Color Rendering Index / Indice de Rendu des Couleurs: (CRI): Ra>80

Code	Power Puissance (W)	LED Type Type De LED	LED Module Module LED	Lum. Flux Flux Lum. (lm)	Color Temperature Température De Couleur (K)	Dimensions (mm)			Weight Poids (kg)	Packing Quantity Colisage	Pcs./20" Container Pcs./20" Conteneur
						a	l	h			
PL20U2415	17/m	2835 SMD	PCB	1475/m	2700 - 6500	17,4	1000	17,8	1.9	2	130860

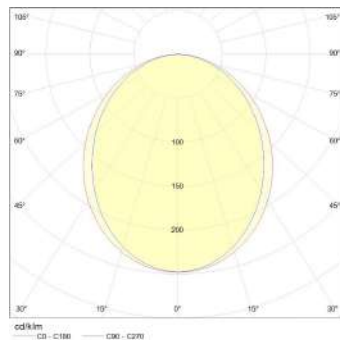
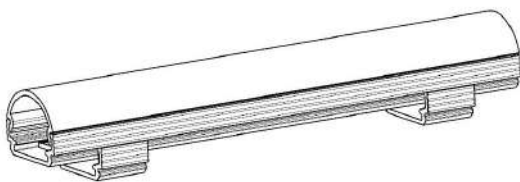
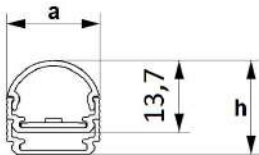

V / Hz    220 - 240 / 50 - 60

<b>NOTE</b> This product is produced in lengths multiples of 125 mm.	<b>NOTE</b> Ce produit est fabriqué en longueurs multiples de 125 mm.
<b>Options</b> Dimmable electronic ballast or convertor. Emergency kit	<b>Options</b> Ballast électronique dimmable ou converteur. Kit d'urgence.
<b>NOTE</b> Given lumen values are net delivered luminaire output lumens.  Given power values are total consumed AC power of the luminaire.	<b>NOTE</b> Les valeurs de lumens données sont les lumens de sortie nets du luminaire.  Les valeurs de puissance données sont la puissance AC totale consommée du luminaire.



 **pamir**<sup>®</sup>  
aydınlıkta



**QUADRO**



## QUADRO

### LED (GU-10)

#### Honeycomb Ceiling Lighting Fixtures

#### Luminaire de Plafond en Nid D'abeille

#### APPLICATION AREAS

Shopping Malls  
Supermarkets  
Offices  
Meeting rooms  
Living Rooms  
Waiting Rooms  
Stores  
Hospitals  
Schools  
Corridors

#### DOMAINES D'UTILISATION

Centres Commerciaux  
Supermarchés  
Bureaux  
Salles de Réunions  
Salles de Séjour  
Salles D'attente  
Magasins  
Hopitaux  
Ecoles  
Couloirs

#### BODY

0.70mm thick DKP metal sheet body.

#### COLOR

Black body as standard. As an option, it can be produced in ceiling color.

#### SUPPLY

220V AC supply, easy connection with push-in terminal block.

#### LED

20.000 hours lifetime LED Bulb with GU-10 lampholder.

#### CORPS

Corps en tôle DKP de 0,70 mm d'épaisseur.

#### COULEUR

Corps noir en standard. En option, il peut être réalisé en couleur plafond.

#### D'ALIMENTATION

Alimentation 220V AC, raccordement facile avec bornier push-in.

#### LED

Ampoule LED d'une durée de vie de 20 000 heures avec douille GU-10.

Color Options  
Options de Couleur



LED Type / Type LED

Color Rendering Index / Indice de Rendu des Couleurs: (CRI): Ra>80

Code	Power Puissance (W)	LED Type Type De LED	LED Module Module LED	Lum. Flux Flux Lum. (lm)	Color Temperature Température De Couleur (K)	Dimensions (mm)			Packing Quantity Colisage	Pcs./20" Container Pcs./20" Conteneur
						a	b	h		
PL19A11Q8	4	GU-10	SMD	340	3000 - 6500	100	100	76	1	15600
PL19A11Q10	4	GU-10	SMD	340	3000 - 6500	119	119	76	1	12000
PL19A12Q8	8	GU-10	SMD	680	3000 - 6500	200	100	76	1	9000
PL19A12Q10	8	GU-10	SMD	680	3000 - 6500	237	119	76	1	6900
PL19A22Q8	16	GU-10	SMD	1360	3000 - 6500	200	200	76	1	5100
PL19A22Q10	16	GU-10	SMD	1360	3000 - 6500	237	237	76	1	4000

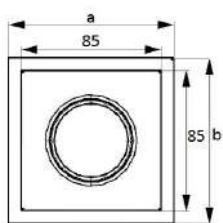

PL19A11Q8

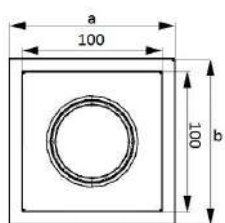

PL19A11Q10

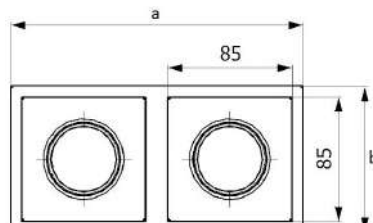

PL19A12Q8

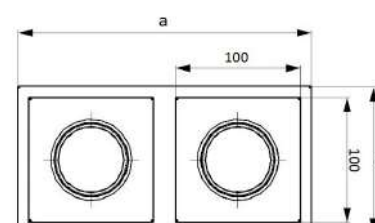

PL19A12Q10

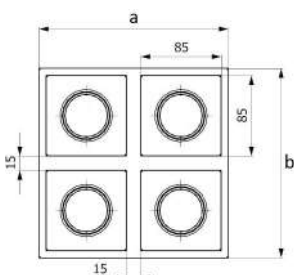

PL19A22Q8

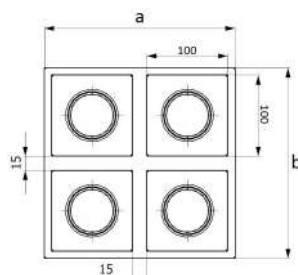

PL19A22Q10

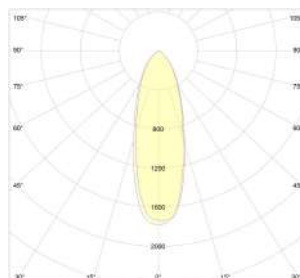

V / Hz 220 - 240 / 50 - 60

NOTE	NOTE
Given lumen values are net delivered luminaire output lumens.	Les valeurs de lumens données sont les lumens de sortie nets du luminaire.
Given power values are total consumed AC power of the luminaire.	Les valeurs de puissance données sont la puissance AC totale consommée du luminaire.

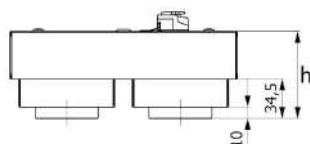





**SURFACE MOUNTED**







# SURFACE BACK LIGHT

## LED

### Surface Mounted Lighting Fixtures With Frosted Diffuser

### Luminaire Apparents Avec Diffuseur Givré

#### APPLICATION AREAS

Shopping Malls  
Supermarkets  
Offices  
Meeting rooms  
Stores  
Hospitals  
Schools  
Corridors

#### DOMAINES D'UTILISATION

Centres Commerciaux  
Supermarchés  
Bureaux  
Salles de Réunions  
Magasins  
Hopitaux  
Ecoles  
Couloirs

#### BODY

Electrostatic powder coated sheetmetal.

#### DIFFUSER

UV stabilized frosted diffuser.

#### CONVERTER

Long life, low power loss converter with constant current.  
Compatible with ENEC standards.

#### LED

LED modules with 60.000 hours lifetime LUMILEDS / SAMSUNG / NICHIA / SEOUL brand LEDs.

#### CORPS

Feuille de métal peinte électrostatiquement.

#### DIFFUSEUR

Diffuseur givré. Anti UV.

#### CONVERTEUR

Convertisseur, conforme aux normes ENEC. Longue vie. Perte de puissance faible avec courant constant .

#### LED

Modules LED – Durée de vie 60.000 heures avec LED de marque LUMILEDS / SAMSUNG / NICHIA / SEOUL.



## LED Type / Type LED

Color Rendering Index / Indice de Rendu des Couleurs: (CRI): Ra>80

Code	Power Puissance (W)	LED Type Type De LED	LED Module Module LED	Lum. Flux Flux Lum. (lm)	Color Temperature Température De Couleur (K)	Dimensions (mm)			Weight Poids (kg)	Packing Quantity Colisage	Pcs./20" Container Pcs./20" Conteneur
						a	b	h			
PL11U11E05C	15	2835 SMD	PCB	1445	2700 - 6500	300	300	64	2.0	4	2600
PL11U12E04C	20	2835 SMD	PCB	2125	2700 - 6500	300	600	64	3.0	2	1318
PL11U12E05C	28	2835 SMD	PCB	2865	2700 - 6500	300	600	64	3.0	2	1318
PL11U14E04C	36	2835 SMD	PCB	3825	2700 - 6500	300	1200	64	4.6	2	680
PL11U14E05C	42	2835 SMD	PCB	4330	2700 - 6500	300	1200	64	4.6	2	680
PL11U14E06C	56	2835 SMD	PCB	5460	2700 - 6500	300	1200	64	4.6	2	680
PL11U22E04C	36	2835 SMD	PCB	3825	2700 - 6500	600	600	64	3.5	2	700
PL11U22E05C	42	2835 SMD	PCB	4330	2700 - 6500	600	600	64	3.5	2	700
PL11U22E06C	56	2835 SMD	PCB	5460	2700 - 6500	600	600	64	3.5	2	700
PL11U24E04C	72	2835 SMD	PCB	7645	2700 - 6500	600	1200	64	7.0	2	360
PL11U24E05C	84	2835 SMD	PCB	8660	2700 - 6500	600	1200	64	7.0	2	360
PL11U24E06C	112	2835 SMD	PCB	10920	2700 - 6500	600	1200	64	7.0	2	360

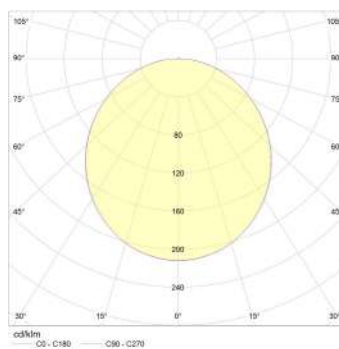
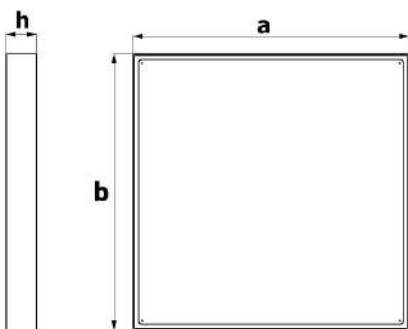

V / Hz 220 - 240 / 50 - 60

Options	Options
Dimmable electronic ballast or convertor.	Ballast électronique dimmable ou converteur.
Emergency kit	Kit d'urgence.
NOTE	NOTE
Given lumen values are net delivered luminaire output lumens.	Les valeurs de lumens données sont les lumens de sortie nets du luminaire.
Given power values are total consumed AC power of the luminaire.	Les valeurs de puissance données sont la puissance AC totale consommée du luminaire.



 **pamir**<sup>®</sup>  
aydınlıkta



**STERILE  
STÉRILE**



**STERILE**

## LED

Recessed Lighting Fixtures With Frosted Diffuser

Luminaire Encastrés Avec Diffuseur Givré

### APPLICATION AREAS

Patient Rooms  
Surgery Rooms  
Consulting Rooms

### DOMAINES D'UTILISATION

Chambres Des Patients  
Salles d'Opération  
Salles de Consultation

#### BODY

Electrostatic powder coated sheetmetal.

#### DIFFUSER

UV stabilized frosted diffuser.

#### CONVERTER

Long life, low power loss converter with constant current.  
Compatible with ENEC standards.

#### LED

LED modules with 60.000 hours lifetime LUMILEDS / SAMSUNG / NICHIA / SEOUL brand LEDs.

#### SEAL

Thermoplastic elastomer.

#### GLASS

4mm tempered glass (with certificate).

#### CORPS

Feuille de métal peinte électrostatiquement.

#### DIFFUSEUR

Diffuseur givré. Anti UV.

#### CONVERTEUR

Convertisseur, conforme aux normes ENEC. Longue vie. Perte de puissance faible avec courant constant.

#### LED

Modules LED – Durée de vie 60.000 heures avec LED de marque LUMILEDS / SAMSUNG / NICHIA / SEOUL.

#### JOINT

Elastomère thermoplastique.

#### VERRE

4 mm verre trempé (avec certificat).

Ceiling Mounting System  
Système de Montage au Plafond

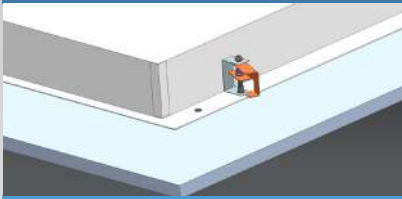

LED Type / Type LED

Color Rendering Index / Indice de Rendu des Couleurs: (CRI): Ra>80

Code	Power Puissance (W)	LED Type Type De LED	LED Module Module LED	Lum. Flux Flux Lum. (lm)	Color Temperature Température De Couleur (K)	Dimensions (mm)					Weight Poids (kg)	Packing Quantity Colisage	Pcs./20" Container Pcs./20" Conteneur
						a1	a2	b1	b2	h			
PL12A11E05C	15	2835 SMD	PCB	1260	2700 - 6500	356	335	356	335	85	2.5	2	2596
PL12A12E04C	20	2835 SMD	PCB	1850	2700 - 6500	356	335	656	635	85	3.5	2	1318
PL12A12E05C	28	2835 SMD	PCB	2100	2700 - 6500	356	335	656	635	85	3.5	2	1318
PL12A14E04C	36	2835 SMD	PCB	3330	2700 - 6500	356	335	1228	1205	85	5.5	2	680
PL12A14E05C	42	2835 SMD	PCB	3775	2700 - 6500	356	335	1228	1205	85	5.5	2	680
PL12A14E06C	56	2835 SMD	PCB	4760	2700 - 6500	356	335	1228	1205	85	5.5	2	680
PL12A22E04C	36	2835 SMD	PCB	3330	2700 - 6500	616	595	616	595	85	7.0	2	700
PL12A22E05C	42	2835 SMD	PCB	3775	2700 - 6500	616	595	616	595	85	7.0	2	700
PL12A22E06C	56	2835 SMD	PCB	4760	2700 - 6500	616	595	616	595	85	7.0	2	700

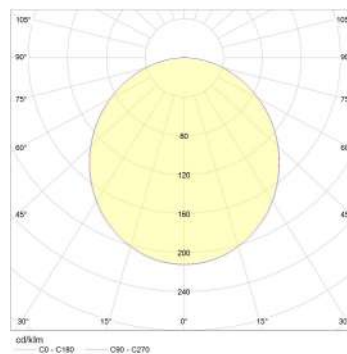
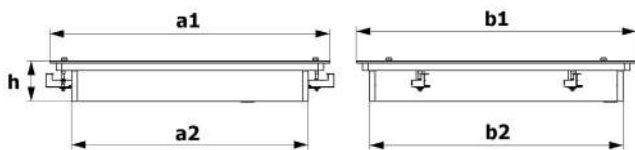

V / Hz 220 - 240 / 50 - 60

Options	Options
Dimmable electronic ballast or convertor. Emergency kit	Ballast électronique dimmable ou converteur. Kit d'urgence.

NOTE	NOTE
Given lumen values are net delivered luminaire output lumens.	Les valeurs de lumens données sont les lumens de sortie nets du luminaire.
Given power values are total consumed AC power of the luminaire.	Les valeurs de puissance données sont la puissance AC totale consommée du luminaire.



## STERILE INDIRECT

### LED

#### Recessed Lighting Fixtures With Frosted Diffuser

#### Luminaire Encastrés Avec Diffuseur Givré

#### APPLICATION AREAS

Patient Rooms  
Surgery Rooms  
Consulting Rooms

#### DOMAINES D'UTILISATION

Chambres Des Patients  
Salles d'Opération  
Salles de Consultation

#### BODY

Electrostatic powder coated sheetmetal.

#### DIFFUSER

UV stabilized frosted diffuser.

#### CONVERTER

Long life, low power loss converter with constant current.  
Compatible with ENEC standards.

#### LED

LED modules with 60.000 hours lifetime LUMILEDS / SAMSUNG / NICHIA / SEOUL brand LEDs.

#### SEAL

Thermoplastic elastomer.

#### GLASS

4mm tempered glass (with certificate)

#### CORPS

Feuille de métal peinte électrostatiquement.

#### DIFFUSEUR

Diffuseur givré. Anti UV.

#### CONVERTEUR

Convertisseur, conforme aux normes ENEC. Longue vie. Perte de puissance faible avec courant constant.

#### LED

Modules LED – Durée de vie 60.000 heures avec LED de marque LUMILEDS / SAMSUNG / NICHIA / SEOUL.

#### JOINT

Elastomère thermoplastique.

#### VERRE

4 mm verre trempé (avec certificat)

Ceiling Mounting System  
Système de Montage au Plafond

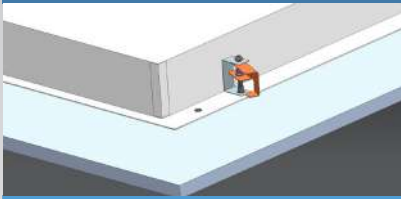

LED Type / Type LED

Color Rendering Index / Indice de Rendu des Couleurs: (CRI): Ra>80

Code	Power Puissance (W)	LED Type Type De LED	LED Module Module LED	Lum. Flux Flux Lum. (lm)	Color Temperature Température De Couleur (K)	Dimensions (mm)					Weight Poids (kg)	Packing Quantity Colisage	Pcs./20" Container Pcs./20" Conteneur
						a1	a2	b1	b2	h			
PL12EA22L15C	25	2835 SMD	PCB	2525	2700 - 6500	616	595	616	595	85	8.5	2	700

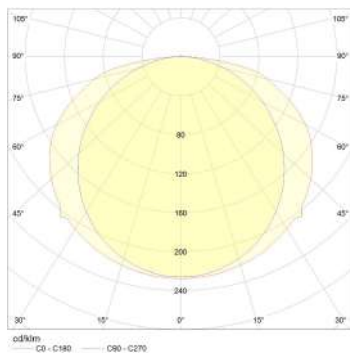
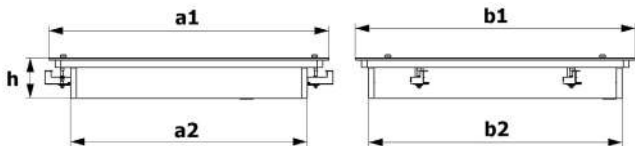

V / Hz 220 - 240 / 50 - 60

Options	Options
Dimmable electronic ballast or convertor. Emergency kit	Ballast électronique dimmable ou converteur. Kit d'urgence.

NOTE	NOTE
Given lumen values are net delivered luminaire output lumens.	Les valeurs de lumens données sont les lumens de sortie nets du luminaire.
Given power values are total consumed AC power of the luminaire.	Les valeurs de puissance données sont la puissance AC totale consommée du luminaire.





 **pamir**<sup>®</sup>  
aydınlıatma



**RECESSED / ENCASTRE**

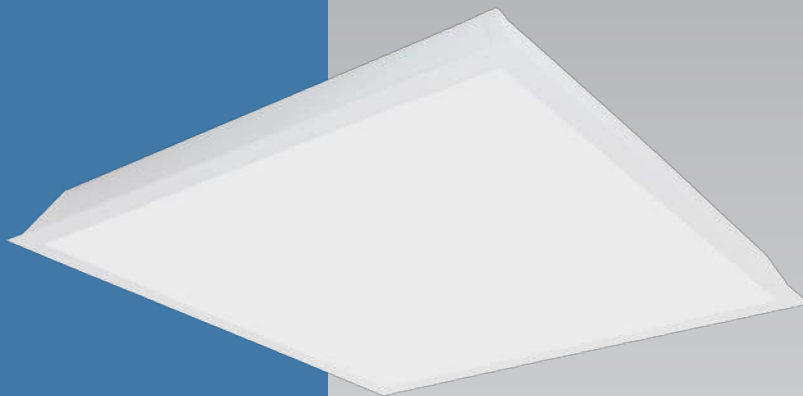

## RECESSED BACK LIGHT T BAR CEILING

### LED

Lighting Fixtures With Frosted Diffuser

Luminaire Avec Diffuseur Givré

#### APPLICATION AREAS

Offices  
Meeting rooms  
Stores  
Hospitals  
Schools  
Corridors

#### DOMAINES D'UTILISATION

Bureaux  
Salles de Réunion  
Magasins  
Hopitaux  
Ecoles  
Couloirs

#### BODY

Electrostatic powder coated sheetmetal.

#### DIFFUSER

UV stabilized frosted diffuser.

#### CONVERTER

Long life, low power loss converter with constant current.  
Compatible with ENEC standards.

#### LED

LED modules with 60.000 hours lifetime LUMILEDS /  
SAMSUNG / NICHIA / SEOUL brand LEDs.

#### CORPS

Feuille de métal peinte électrostatiquement.

#### DIFFUSEUR

Diffuseur givré. Anti UV.

#### CONVERTEUR

Convertisseur, conforme aux normes ENEC. Longue vie. Perte de puissance faible avec courant constant .

#### LED

Modules LED – Durée de vie 60.000 heures avec LED de marque LUMILEDS / SAMSUNG / NICHIA / SEOUL.

Ceiling Mounting System  
Système de Montage au Plafond



LED Type / Type LED

Color Rendering Index / Indice de Rendu des Couleurs: (CRI): Ra>80

Code	Power Puissance (W)	LED Type Type De LED	LED Module Module LED	Lum. Flux Flux Lum. (lm)	Color Temperature Température De Couleur (K)	Dimensions (mm)					Weight Poids (kg)	Packing Quantity Colisage	Pcs./20" Container Pcs./20" Conteneur
						a1	a2	b1	b2	h			
PL11A11E05C	15	2835 SMD	PCB	1445	2700 - 6500	293	268	293	268	60	1.5	2	2596
PL11A12E04C	20	2835 SMD	PCB	2125	2700 - 6500	293	268	593	568	60	2.5	2	1318
PL11A12E05C	28	2835 SMD	PCB	2865	2700 - 6500	293	268	593	568	60	2.5	2	1318
PL11A14E04C	36	2835 SMD	PCB	3825	2700 - 6500	293	268	1193	1168	60	4.1	2	680
PL11A14E05C	42	2835 SMD	PCB	4330	2700 - 6500	293	268	1193	1168	60	4.1	2	680
PL11A14E06C	56	2835 SMD	PCB	5460	2700 - 6500	293	268	1193	1168	60	4.1	2	680
PL11A22E04C	36	2835 SMD	PCB	3825	2700 - 6500	593	568	593	568	60	3.0	2	700
PL11A22E05C	42	2835 SMD	PCB	4330	2700 - 6500	593	568	593	568	60	3.0	2	700
PL11A22E06C	56	2835 SMD	PCB	5460	2700 - 6500	593	568	593	568	60	3.0	2	700
PL11A24E04C	72	2835 SMD	PCB	6665	2700 - 6500	593	568	1193	1168	60	6.0	2	360
PL11A24E05C	84	2835 SMD	PCB	7550	2700 - 6500	593	568	1193	1168	60	6.0	2	360
PL11A24E06C	112	2835 SMD	PCB	9520	2700 - 6500	593	568	1193	1168	60	6.0	2	360

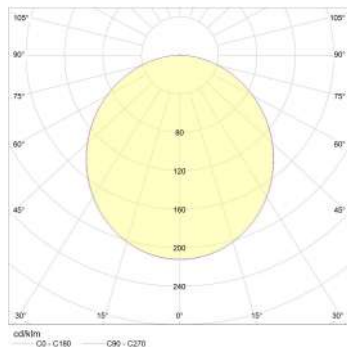
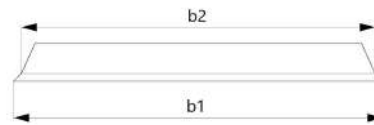
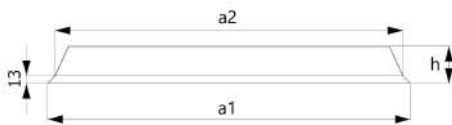

V / Hz | 220 - 240 / 50 - 60

Options	Options
Dimmable electronic ballast or convertor. Emergency kit	Ballast électronique dimmable ou converteur. Kit d'urgence.
NOTE	NOTE
Given lumen values are net delivered luminaire output lumens.	Les valeurs de lumens données sont les lumens de sortie nets du luminaire.
Given power values are total consumed AC power of the luminaire.	Les valeurs de puissance données sont la puissance AC totale consommée du luminaire.



## RECESSED BACK LIGHT GYPSUM CEILING

### LED

Lighting Fixtures With Frosted Diffuser

Luminaire Avec Diffuseur Givré

#### APPLICATION AREAS

Offices  
Meeting rooms  
Stores  
Hospitals  
Schools  
Corridors

#### DOMAINES D'UTILISATION

Bureaux  
Salles de Réunion  
Magasins  
Hopitaux  
Ecoles  
Couloirs

#### BODY

Electrostatic powder coated sheetmetal.

#### DIFFUSER

UV stabilized frosted diffuser.

#### CONVERTER

Long life, low power loss converter with constant current.  
Compatible with ENEC standards.

#### LED

LED modules with 60.000 hours lifetime LUMILEDS /  
SAMSUNG / NICHIA / SEOUL brand LEDs.

#### CORPS

Feuille de métal peinte électrostatiquement.

#### DIFFUSEUR

Diffuseur givré. Anti UV.

#### CONVERTEUR

Convertisseur, conforme aux normes ENEC. Longue vie. Perte de puissance faible avec courant constant .

#### LED

Modules LED – Durée de vie 60.000 heures avec LED de marque LUMILEDS / SAMSUNG / NICHIA / SEOUL.

Ceiling Mounting System  
Système de Montage au Plafond

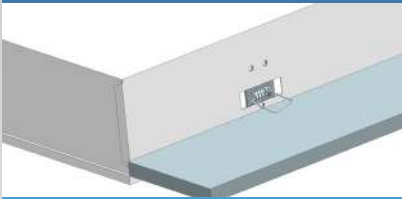

LED Type / Type LED

Color Rendering Index / Indice de Rendu des Couleurs: (CRI): Ra>80

Code	Power Puissance (W)	LED Type Type De LED	LED Module Module LED	Lum. Flux Flux Lum. (lm)	Color Temperature Température De Couleur (K)	Dimensions (mm)					Weight Poids (kg)	Packing Quantity Colisage	Pcs./20" Container Pcs./20" Conteneur
						a1	a2	b1	b2	h			
PL11AY11E05C	15	2835 SMD	PCB	1445	2700 - 6500	295	275	295	275	65	1.5	2	2596
PL11AY12E04C	20	2835 SMD	PCB	2125	2700 - 6500	295	275	595	575	65	2.5	2	1318
PL11AY12E05C	28	2835 SMD	PCB	2865	2700 - 6500	295	275	595	575	65	2.5	2	1318
PL11AY14E04C	36	2835 SMD	PCB	3825	2700 - 6500	295	275	1195	1175	65	4.1	2	680
PL11AY14E05C	42	2835 SMD	PCB	4330	2700 - 6500	295	275	1195	1175	65	4.1	2	680
PL11AY14E06C	56	2835 SMD	PCB	5460	2700 - 6500	295	275	1195	1175	65	4.1	2	680
PL11AY22E04C	36	2835 SMD	PCB	3825	2700 - 6500	595	575	595	575	65	3.0	2	700
PL11AY22E05C	42	2835 SMD	PCB	4330	2700 - 6500	595	575	595	575	65	3.0	2	700
PL11AY22E06C	56	2835 SMD	PCB	5460	2700 - 6500	595	575	595	575	65	3.0	2	700
PL11AY24E04C	72	2835 SMD	PCB	6665	2700 - 6500	595	575	1195	1175	65	6.0	2	360
PL11AY24E05C	84	2835 SMD	PCB	7550	2700 - 6500	595	575	1195	1175	65	6.0	2	360
PL11AY24E06C	112	2835 SMD	PCB	9520	2700 - 6500	595	575	1195	1175	65	6.0	2	360

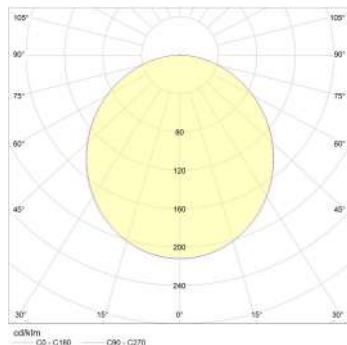
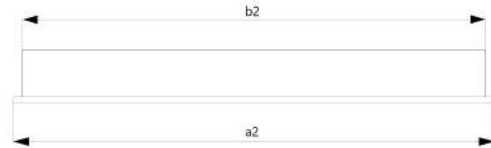
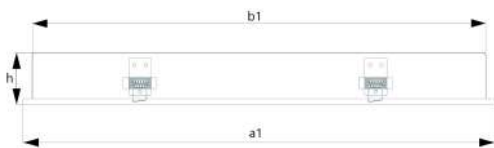

V / Hz 220 - 240 / 50 - 60

Options	Options
Dimmable electronic ballast or convertor.	Ballast électronique dimmable ou converteur.
Emergency kit	Kit d'urgence.
NOTE	NOTE
Given lumen values are net delivered luminaire output lumens.	Les valeurs de lumens données sont les lumens de sortie nets du luminaire.
Given power values are total consumed AC power of the luminaire.	Les valeurs de puissance données sont la puissance AC totale consommée du luminaire.



## RECESSED INDIRECT

### LED

#### Indirect Lighting Fixtures With Frosted Diffuser

#### Indirect Luminaires Avec Diffuseur Givré

#### APPLICATION AREAS

Offices  
Meeting rooms  
Stores  
Hospitals  
Schools  
Corridors

#### DOMAINES D'UTILISATION

Bureaux  
Salles de Réunion  
Magasins  
Hopitaux  
Ecoles  
Couloirs

#### BODY

Electrostatic powder coated sheetmetal.

#### DIFFUSER

UV stabilized frosted diffuser.

#### CONVERTER

Long life, low power loss converter with constant current.  
Compatible with ENEC standards.

#### LED

LED modules with 60.000 hours lifetime LUMILEDS / SAMSUNG / NICHIA brand LEDs.

#### CORPS

Feuille de métal peinte électrostatiquement.

#### DIFFUSEUR

Diffuseur givré. Anti UV.

#### CONVERTEUR

Convertisseur, conforme aux normes ENEC. Longue vie. Perte de puissance faible avec courant constant .

#### LED

Modules LED – Durée de vie 60.000 heures avec LED de marque LUMILEDS / SAMSUNG / NICHIA.



LED Type / Type LED

Color Rendering Index / Indice de Rendu des Couleurs: (CRI): Ra>80

Code	Power Puissance (W)	LED Type Type De LED	LED Module Module LED	Lum. Flux Flux Lum. (lm)	Color Temperature Température De Couleur (K)	Dimensions (mm)			Weight Poids (kg)	Packing Quantity Colisage	Pcs./20" Container Pcs./20" Conteneur
						a	b	h			
PL11EA22L15C	26	2835 SMD	PCB	2900	2700 - 6500	595	575	78	3.5	2	700

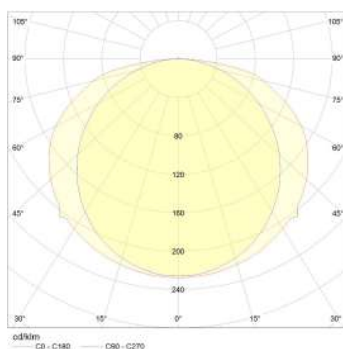
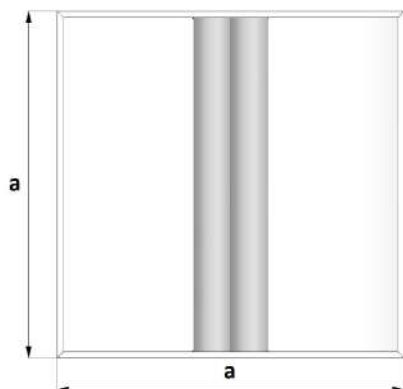
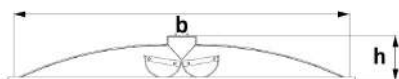

V / Hz | 220 - 240 / 50 - 60

Options	Options
Dimmable electronic ballast or convertor.	Ballast électronique dimmable ou converteur.
Emergency kit	Kit d'urgence.

NOTE	NOTE
Given lumen values are net delivered luminaire output lumens.	Les valeurs de lumens données sont les lumens de sortie nets du luminaire.
Given power values are total consumed AC power of the luminaire.	Les valeurs de puissance données sont la puissance AC totale consommée du luminaire.





 **pamir**<sup>®</sup>  
aydınlatma



**CLIP - IN**



## CLIP-IN BACK LIGHT

### LED

Lighting Fixtures With Frosted Diffuser

Luminaire Avec Diffuseur Givré

#### APPLICATION AREAS

Offices  
Meeting rooms  
Stores  
Hospitals  
Schools  
Corridors

#### DOMAINES D'UTILISATION

Bureaux  
Salles de Réunion  
Magasins  
Hopitaux  
Ecoles  
Couloirs

#### BODY

Electrostatic powder coated sheetmetal.

#### DIFFUSER

UV stabilized frosted diffuser.

#### CONVERTER

Long life, low power loss converter with constant current.  
Compatible with ENEC standards.

#### LED

LED modules with 60.000 hours lifetime LUMILEDS / SAMSUNG / NICHIA / SEOUL brand LEDs.

#### CORPS

Feuille de métal peinte électrostatiquement.

#### DIFFUSEUR

Diffuseur givré. Anti UV.

#### CONVERTEUR

Convertisseur, conforme aux normes ENEC. Longue vie. Perte de puissance faible avec courant constant .

#### LED

Modules LED – Durée de vie 60.000 heures avec LED de marque LUMILEDS / SAMSUNG / NICHIA / SEOUL.



## LED Type / Type LED

Color Rendering Index / Indice de Rendu des Couleurs: (CRI): Ra>80

Code	Power Puissance (W)	LED Type Type De LED	LED Module Module LED	Lum. Flux Flux Lum. (lm)	Color Temperature Température De Couleur (K)	Dimensions (mm)					Weight Poids (kg)	Packing Quantity Colisage	Pcs./20" Container Pcs./20" Conteneur
						a1	a2	b1	b2	h			
PL11C11E05C	15	2835 SMD	PCB	1445	2700 - 6500	300	272	300	272	65	1.5	2	1318
PL11C12E04C	20	2835 SMD	PCB	2125	2700 - 6500	300	272	600	572	65	2.5	2	1318
PL11C12E05C	28	2835 SMD	PCB	2865	2700 - 6500	300	272	600	572	65	2.5	2	1318
PL11C14E04C	36	2835 SMD	PCB	3825	2700 - 6500	300	272	1200	1172	65	4.1	2	680
PL11C14E05C	42	2835 SMD	PCB	4330	2700 - 6500	300	272	1200	1172	65	4.1	2	680
PL11C14E06C	56	2835 SMD	PCB	5460	2700 - 6500	300	272	1200	1172	65	4.1	2	680
PL11C22E04C	36	2835 SMD	PCB	3825	2700 - 6500	600	572	600	572	65	3.0	2	700
PL11C22E05C	42	2835 SMD	PCB	4330	2700 - 6500	600	572	600	572	65	3.0	2	700
PL11C22E06C	56	2835 SMD	PCB	7000	2700 - 6500	600	572	600	572	65	3.0	2	700
PL11C24E04C	72	2835 SMD	PCB	6665	2700 - 6500	600	572	1200	1172	65	6.0	2	360
PL11C24E05C	84	2835 SMD	PCB	7550	2700 - 6500	600	572	1200	1172	65	6.0	2	360
PL11C24E06C	112	2835 SMD	PCB	9520	2700 - 6500	600	572	1200	1172	65	6.0	2	360

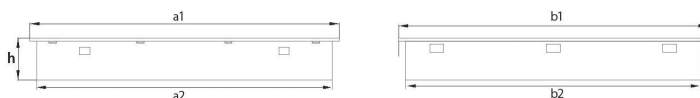

V / Hz 220 - 240 / 50 - 60

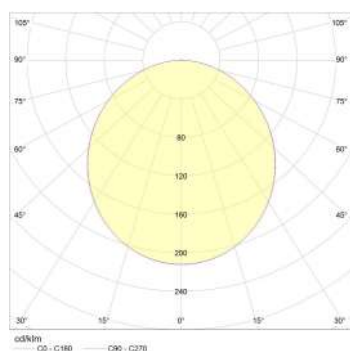

Options	Options
Dimmable electronic ballast or convertor. Emergency kit	Ballast électronique dimmable ou converteur. Kit d'urgence.
<b>NOTE</b> Given lumen values are net delivered luminaire output lumens.  Given power values are total consumed AC power of the luminaire.	<b>NOTE</b> Les valeurs de lumens données sont les lumens de sortie nets du luminaire.  Les valeurs de puissance données sont la puissance AC totale consommée du luminaire.





**TRIM LINE**

# TRIM LINE

## LED

### Recessed Lighting Fixtures With Diffuser

### Luminaire Encastrés Avec Diffuseur

#### APPLICATION AREAS

Shopping Malls  
Supermarkets  
Offices  
Meeting rooms  
Stores  
Hospitals  
Schools

#### DOMAINES D'UTILISATION

Centres Commerciaux  
Supermarchés  
Bureaux  
Salles de Réunions  
Magasins  
Hopitaux  
Ecoles

#### BODY

White colored aluminium.

#### DIFFUSER

UV stabilized extruded PC diffuser.

#### CONVERTER

Long life, low power loss converter with constant current.  
Compatible with ENEC standards.

#### LED

LED modules with 60.000 hours lifetime LUMILEDS / SAMSUNG / NICHIA brand LEDs.

#### CORPS

Corps en aluminium de couleur blanc. Design Elegant.

#### DIFFUSEUR

Diffuseur en PC extrudé stabilisé aux UV.

#### CONVERTEUR

Convertisseur, conforme aux normes ENEC. Longue vie. Perte de puissance faible avec courant constant.

#### LED

Modules LED – Durée de vie 60.000 heures avec LED de marque LUMILEDS / SAMSUNG / NICHIA.

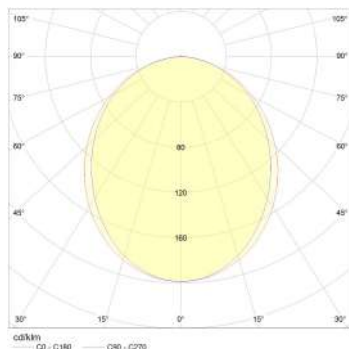

V / Hz 220 - 240 / 50 - 60

Options	Options
Dimmable electronic ballast or convertor.	Ballast électronique dimmable ou converteur.
Emergency kit	Kit d'urgence.
NOTE	NOTE
Given lumen values are net delivered luminaire output lumens.	Les valeurs de lumens données sont les lumens de sortie nets du luminaire.
Given power values are total consumed AC power of the luminaire.	Les valeurs de puissance données sont la puissance AC totale consommée du luminaire.

Ceiling Mounting System  
Système de Montage au Plafond

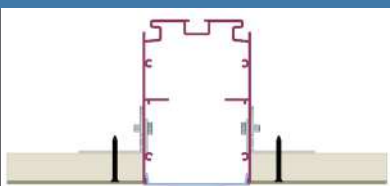

LED Type / Type LED

Color Rendering Index / Indice de Rendu des Couleurs: (CRI): Ra>80

Code	Power Puissance (W)	LED Type Type De LED	LED Module Module LED	Lum. Flux Flux Lum. (lm)	Color Temperature Température De Couleur (K)	Dimensions (mm)			Weight Poids (kg)	Packing Quantity Colisage	Pcs./20" Container Pcs./20" Conteneur
						a	l	h			
PL13A12L15C	14	2835 SMD	PCB	990	2700 - 6500	63	570	95	1.2	2	2908
PL13A12L25C	21	2835 SMD	PCB	1490	2700 - 6500	63	570	95	1.2	2	2908
PL13A13L15C	21	2835 SMD	PCB	1485	2700 - 6500	63	850	95	1.7	2	2908
PL13A13L25C	30	2835 SMD	PCB	2230	2700 - 6500	63	850	95	1.8	2	2908
PL13A14L15C	26	2835 SMD	PCB	1980	2700 - 6500	63	1130	95	2.1	2	2268
PL13A14L25C	41	2835 SMD	PCB	2975	2700 - 6500	63	1130	95	2.2	2	2268
PL13A15L15C	33	2835 SMD	PCB	2470	2700 - 6500	63	1412	95	2.5	2	1836
PL13A15L15CSB	33	2835 SMD	PCB	2470	2700 - 6500	63	1408	95	2.5	2	1836
PL13A15L15CSO	33	2835 SMD	PCB	2470	2700 - 6500	63	1404	95	2.5	2	1836
PL13A15L25C	51	2835 SMD	PCB	3720	2700 - 6500	63	1412	95	2.6	2	1836
PL13A15L25CSB	51	2835 SMD	PCB	3720	2700 - 6500	63	1408	95	2.6	2	1836
PL13A15L25CSO	51	2835 SMD	PCB	3720	2700 - 6500	63	1404	95	2.6	2	1836
PL13A16L15C	39	2835 SMD	PCB	2965	2700 - 6500	63	1693	95	2.9	2	1576
PL13A16L15CSB	39	2835 SMD	PCB	2965	2700 - 6500	63	1689	95	2.9	2	1576
PL13A16L15CSO	39	2835 SMD	PCB	2965	2700 - 6500	63	1685	95	2.9	2	1576
PL13A16L25C	61	2835 SMD	PCB	4465	2700 - 6500	63	1693	95	3.0	2	1576
PL13A16L25CSB	61	2835 SMD	PCB	4465	2700 - 6500	63	1689	95	3.0	2	1576
PL13A16L25CSO	61	2835 SMD	PCB	4465	2700 - 6500	63	1685	95	3.0	2	1576
PL13A17L15C	47	2835 SMD	PCB	3460	2700 - 6500	63	1973	95	3.3	2	1248
PL13A17L15CSB	47	2835 SMD	PCB	3460	2700 - 6500	63	1969	95	3.3	2	1248
PL13A17L15CSO	47	2835 SMD	PCB	3460	2700 - 6500	63	1965	95	3.3	2	1248
PL13A17L25C	70	2835 SMD	PCB	5205	2700 - 6500	63	1973	95	3.3	2	1248
PL13A17L25CSB	70	2835 SMD	PCB	5205	2700 - 6500	63	1969	95	3.3	2	1248
PL13A17L25CSO	70	2835 SMD	PCB	5205	2700 - 6500	63	1965	95	3.3	2	1248
PL13A18L15C	53	2835 SMD	PCB	3955	2700 - 6500	63	2254	95	3.7	2	1248
PL13A18L15CSB	53	2835 SMD	PCB	3955	2700 - 6500	63	2250	95	3.7	2	1248
PL13A18L15CSO	53	2835 SMD	PCB	3955	2700 - 6500	63	2246	95	3.7	2	1248
PL13A19L15C	60	2835 SMD	PCB	4450	2700 - 6500	63	2534	95	4.1	2	1004
PL13A19L15CSB	60	2835 SMD	PCB	4450	2700 - 6500	63	2530	95	4.1	2	1004
PL13A19L15CSO	60	2835 SMD	PCB	4450	2700 - 6500	63	2526	95	4.1	2	1004
PL13A10L15C	66	2835 SMD	PCB	4940	2700 - 6500	63	2815	95	4.5	2	1004
PL13A10L15CSB	66	2835 SMD	PCB	4940	2700 - 6500	63	2811	95	4.5	2	1004
PL13A10L15CSO	66	2835 SMD	PCB	4940	2700 - 6500	63	2807	95	4.5	2	1004

Visible frame width / Largeur de cadre visible: 63mm

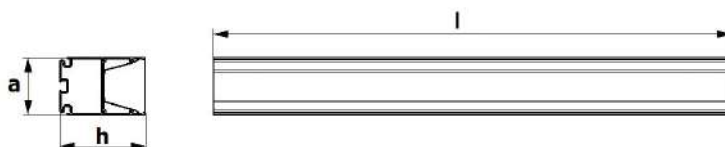





 **pamir**<sup>®</sup>  
aydinlatma





**ASYMMETRIC**





## ASYMMETRIC SURFACE

### LED

#### Surface Mounted Asymmetric Lighting Fixtures With Diffuser

#### Asymétrique Luminaires Apparents Avec Diffuseur Givré

##### BODY

White or silver color options aluminum.

##### DIFFUSER

UV stabilized frosted diffuser.

##### CONVERTER

Long life, low power loss converter with constant current.  
Compatible with ENEC standards.

##### LED

LED modules with 60.000 hours lifetime LUMILEDS /  
SAMSUNG / NICHIA brand LEDs.

##### APPLICATION AREAS

Shopping Malls  
Supermarkets  
Offices  
Meeting rooms  
Stores  
Hospitals  
Schools  
Corridors

##### DOMAINES D'UTILISATION

Centres Commerciaux  
Supermarchés  
Bureaux  
Salles de Réunions  
Magasins  
Hopitaux  
Ecoles  
Couloirs

##### CORPS

Corps en aluminium de couleurs argent et blanc disponibles. Design Elegant.

##### DIFFUSEUR

Diffuseur givré. Anti UV.

##### CONVERTEUR

Convertisseur, conforme aux normes ENEC. Longue vie. Perte de puissance faible avec courant constant .

##### LED

Modules LED – Durée de vie 60.000 heures avec LED de marque LUMILEDS / SAMSUNG / NICHIA.

Color Options  
Options de Couleur



LED Type / Type LED

Color Rendering Index / Indice de Rendu des Couleurs: (CRI): Ra>80

Code	Power Puissance (W)	LED Type Type De LED	LED Module Module LED	Lum. Flux Flux Lum. (lm)	Color Temperature Température De Couleur (K)	Dimensions (mm)			Weight Poids (kg)	Packing Quantity Colisage	Pcs./20" Container Pcs./20" Conteneur
						a	l	h			
PL15U12L15C	14	2835 SMD	PCB	950	2700 - 6500	63	573	93	1.7	3	2118
PL15U12L25C	21	2835 SMD	PCB	1430	2700 - 6500	63	573	93	1.8	3	2118
PL15U13L15C	21	2835 SMD	PCB	1425	2700 - 6500	63	854	93	2.1	3	2118
PL15U13L25C	30	2835 SMD	PCB	2145	2700 - 6500	63	854	93	2.2	3	2118
PL15U14L15C	26	2835 SMD	PCB	1900	2700 - 6500	63	1134	93	2.5	3	1701
PL15U14L25C	41	2835 SMD	PCB	2860	2700 - 6500	63	1134	93	2.6	3	1701
PL15U15L15C	33	2835 SMD	PCB	2375	2700 - 6500	63	1415	93	2.9	3	1377
PL15U15L25C	51	2835 SMD	PCB	3575	2700 - 6500	63	1415	93	3.0	3	1377
PL15U16L15C	39	2835 SMD	PCB	2850	2700 - 6500	63	1695	93	3.3	3	1182
PL15U16L25C	61	2835 SMD	PCB	4290	2700 - 6500	63	1695	93	3.5	3	1182
PL15U17L15C	47	2835 SMD	PCB	3325	2700 - 6500	63	1976	93	3.7	3	936
PL15U17L25C	70	2835 SMD	PCB	5005	2700 - 6500	63	1976	93	3.9	3	936
PL15U18L15C	53	2835 SMD	PCB	3800	2700 - 6500	63	2256	93	4.1	3	936
PL15U19L15C	60	2835 SMD	PCB	4275	2700 - 6500	63	2537	93	4.5	3	753
PL15U10L15C	66	2835 SMD	PCB	4750	2700 - 6500	63	2817	93	4.9	3	753

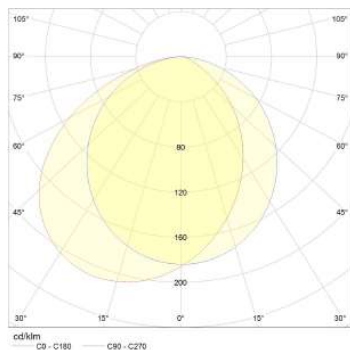
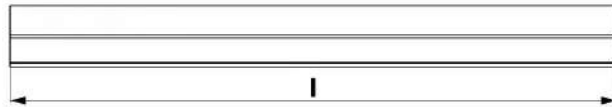
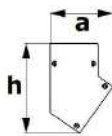

V / Hz 220 - 240 / 50 - 60

Options	Options
Dimmable electronic ballast or converter.	Ballast électronique dimmable ou converteur.
Emergency kit	Kit d'urgence.
NOTE	NOTE
Given lumen values are net delivered luminaire output lumens.	Les valeurs de lumens données sont les lumens de sortie nets du luminaire.
Given power values are total consumed AC power of the luminaire.	Les valeurs de puissance données sont la puissance AC totale consommée du luminaire.



# ASYMMETRIC RECESSED

## LED

### Recessed Asymmetric Lighting Fixtures With Diffuser

### Asymétrique Luminaires Encastrés Diffuseur Givré

#### APPLICATION AREAS

Shopping Malls  
Supermarkets  
Offices  
Meeting rooms  
Stores  
Hospitals  
Schools  
Corridors

#### DOMAINES D'UTILISATION

Centres Commerciaux  
Supermarchés  
Bureaux  
Salles de Réunions  
Magasins  
Hopitaux  
Ecoles  
Couloirs

#### BODY

White or silver color options aluminum.

#### DIFFUSER

UV stabilized extruded PC diffuser.

#### CONVERTER

Long life, low power loss converter with constant current.  
Compatible with ENEC standards.

#### LED

LED modules with 60.000 hours lifetime LUMILEDS /  
SAMSUNG / NICHIA brand LEDs.

#### CORPS

Corps en aluminium de couleurs argent et blanc disponibles. Design Elegant.

#### DIFFUSEUR

Diffuseur en PC extrudé stabilisé aux UV.

#### CONVERTEUR

Convertisseur, conforme aux normes ENEC. Longue vie. Perte de puissance faible avec courant constant .

#### LED

Modules LED – Durée de vie 60.000 heures avec LED de marque LUMILEDS / SAMSUNG / NICHIA.

Color Options  
Options de Couleur



LED Type / Type LED

Color Rendering Index / Indice de Rendu des Couleurs: (CRI): Ra>80

Code	Power Puissance (W)	LED Type Type De LED	LED Module Module LED	Lum. Flux Flux Lum. (lm)	Color Temperature Température De Couleur (K)	Dimensions (mm)			Weight Poids (kg)	Packing Quantity Colisage	Pcs./20" Container Pcs./20" Conteneur
						a	l	h			
PL15A13L15C	21	2835 SMD	PCB	2055	2700 - 6500	88	861	93	1.7	3	2181
PL15A13L25C	30	2835 SMD	PCB	3090	2700 - 6500	88	861	93	1.8	3	2181
PL15A14L15C	26	2835 SMD	PCB	2740	2700 - 6500	88	1141	93	2.1	3	1701
PL15A14L25C	41	2835 SMD	PCB	4120	2700 - 6500	88	1141	93	2.2	3	1701
PL15A15L15C	33	2835 SMD	PCB	3420	2700 - 6500	88	1422	93	2.5	3	1377
PL15A15L25C	51	2835 SMD	PCB	5150	2700 - 6500	88	1422	93	2.6	3	1377
PL15A16L15C	39	2835 SMD	PCB	4105	2700 - 6500	88	1710	93	2.9	3	1182
PL15A16L25C	61	2835 SMD	PCB	6180	2700 - 6500	88	1710	93	3.0	3	1182
PL15A17L15C	47	2835 SMD	PCB	4790	2700 - 6500	88	1999	93	3.3	3	936
PL15A17L25C	70	2835 SMD	PCB	7210	2700 - 6500	88	1999	93	3.5	3	936
PL15A18L15C	53	2835 SMD	PCB	5475	2700 - 6500	88	2280	93	3.7	3	936
PL15A19L15C	60	2835 SMD	PCB	6160	2700 - 6500	88	2560	93	4.1	3	753
PL15A10L15C	66	2835 SMD	PCB	6840	2700 - 6500	88	2837	93	4.5	3	753

Visible frame width / Largeur de cadre visible: 104mm

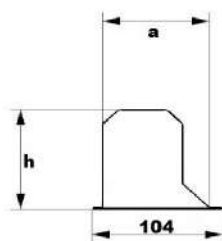
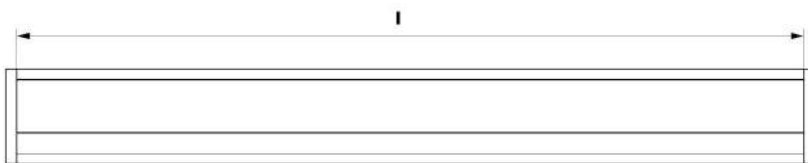

V / Hz 220 - 240 / 50 - 60

Options	Options
Dimmable electronic ballast or convertor. Emergency kit	Ballast électronique dimmable ou converteur. Kit d'urgence.
NOTE	NOTE
Given lumen values are net delivered luminaire output lumens.	Les valeurs de lumens données sont les lumens de sortie nets du luminaire.
Given power values are total consumed AC power of the luminaire.	Les valeurs de puissance données sont la puissance AC totale consommée du luminaire.

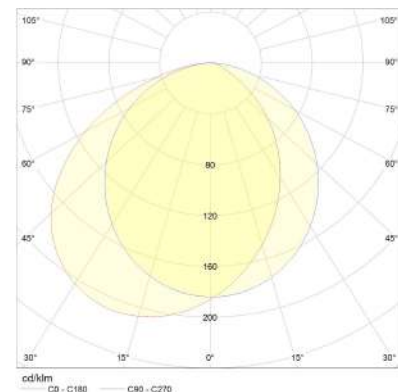



 **pamir**<sup>®</sup>  
aydinlatma





**V-LINE RECESSED**





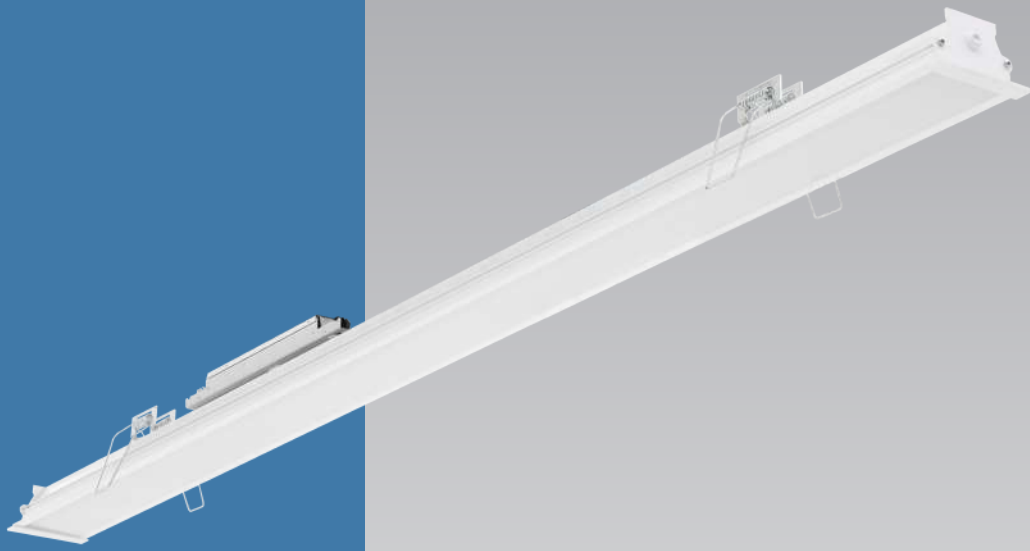

## V-LINE RECESSED

### LED

#### Recessed Lighting Fixtures With Diffuser

#### Luminaire Encastre Avec Diffuseur

#### APPLICATION AREAS

Shopping Malls  
Supermarkets  
Offices  
Meeting rooms  
Stores  
Hospitals  
Schools

#### DOMAINES D'UTILISATION

Centres Commerciaux  
Supermarchés  
Bureaux  
Salles de Réunions  
Magasins  
Hopitaux  
Ecoles

#### BODY

Anodized aluminum with satin finishing. Black and white color options with elegant design.

#### DIFFUSER

UV stabilized extruded PC diffuser.

#### CONVERTER

Long life, low power loss converter with constant current. Compatible with ENEC standards.

#### LED

LED modules with 60.000 hours lifetime LUMILEDS / SAMSUNG / NICHIA brand LEDs.

#### CORPS

Corps en aluminium anodisé, satiné. Design élégant. Couleurs blanc, noir disponibles.

#### DIFFUSEUR

Diffuseur en PC extrudé stabilisé aux UV.

#### CONVERTEUR

Convertisseur, conforme aux normes ENEC. Longue vie. Perte de puissance faible avec courant constant.

#### LED

Modules LED – Durée de vie 60.000 heures avec LED de marque LUMILEDS / SAMSUNG / NICHIA.

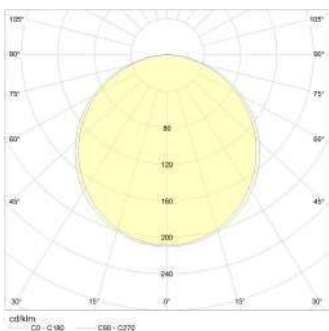

V / Hz 220 - 240 / 50 - 60

#### Options

Dimmable electronic ballast or converter.  
Emergency kit

#### Options

Ballast électronique dimmable ou convertisseur.  
Kit d'urgence.

#### NOTE

Given lumen values are net delivered luminaire output lumens.

Given power values are total consumed AC power of the luminaire.

#### NOTE

Les valeurs de lumens données sont les lumens de sortie nets du luminaire.

Les valeurs de puissance données sont la puissance AC totale consommée du luminaire.

Color Options  
Options de Couleur



LED Type / Type LED

Color Rendering Index / Indice de Rendu des Couleurs: (CRI): Ra>80

Code	Power Puissance (W)	LED Type Type De LED	LED Module Module LED	Lum. Flux Flux Lum. (lm)	Température De Couleur (K)	Dimensions (mm)			Weight Poids (kg)	Packing Quantity Colisage	Pcs./20" Container Pcs./20" Conteneur
						a	l	h			
PL24A13L15C	21	2835 SMD	PCB	1655	2700 - 6500	57	861	61	1.7	4	2908
PL24A13L25C	30	2835 SMD	PCB	2490	2700 - 6500	57	861	61	1.8	4	2908
PL24A14L15C	26	2835 SMD	PCB	2205	2700 - 6500	57	1141	61	2.1	4	2268
PL24A14L25C	41	2835 SMD	PCB	3320	2700 - 6500	57	1141	61	2.2	4	2268
PL24A15L15C	33	2835 SMD	PCB	2755	2700 - 6500	57	1422	61	2.5	4	1826
PL24A15L15CSB	33	2835 SMD	PCB	2755	2700 - 6500	57	1420	61	2.5	4	1826
PL24A15L15CSO	33	2835 SMD	PCB	2755	2700 - 6500	57	1418	61	2.5	4	1826
PL24A15L25C	51	2835 SMD	PCB	4150	2700 - 6500	57	1422	61	2.6	4	1826
PL24A15L25CSB	51	2835 SMD	PCB	4150	2700 - 6500	57	1420	61	2.6	4	1826
PL24A15L25CSO	51	2835 SMD	PCB	4150	2700 - 6500	57	1418	61	2.6	4	1826
PL24A16L15C	39	2835 SMD	PCB	3305	2700 - 6500	57	1711	61	2.9	4	1576
PL24A16L15CSB	39	2835 SMD	PCB	3305	2700 - 6500	57	1709	61	2.9	4	1576
PL24A16L15CSO	39	2835 SMD	PCB	3305	2700 - 6500	57	1707	61	2.9	4	1576
PL24A16L25C	61	2835 SMD	PCB	4975	2700 - 6500	57	1711	61	3.0	4	1576
PL24A16L25CSB	61	2835 SMD	PCB	4975	2700 - 6500	57	1709	61	3.0	4	1576
PL24A16L25CSO	61	2835 SMD	PCB	4975	2700 - 6500	57	1707	61	3.0	4	1576
PL24A17L15C	47	2835 SMD	PCB	3855	2700 - 6500	57	1999	61	3.3	4	1250
PL24A17L15CSB	47	2835 SMD	PCB	3855	2700 - 6500	57	1997	61	3.3	4	1250
PL24A17L15CSO	47	2835 SMD	PCB	3855	2700 - 6500	57	1995	61	3.3	4	1250
PL24A17L25C	70	2835 SMD	PCB	5805	2700 - 6500	57	1999	61	3.5	4	1250
PL24A17L25CSB	70	2835 SMD	PCB	5805	2700 - 6500	57	1997	61	3.5	4	1250
PL24A17L25CSO	70	2835 SMD	PCB	5805	2700 - 6500	57	1995	61	3.5	4	1250
PL24A18L15C	53	2835 SMD	PCB	4410	2700 - 6500	57	2280	61	3.7	4	1250
PL24A18L15CSB	53	2835 SMD	PCB	4410	2700 - 6500	57	2278	61	3.7	4	1250
PL24A18L15CSO	53	2835 SMD	PCB	4410	2700 - 6500	57	2276	61	3.7	4	1250
PL24A19L15C	60	2835 SMD	PCB	4960	2700 - 6500	57	2560	61	4.1	4	1005
PL24A19L15CSB	60	2835 SMD	PCB	4960	2700 - 6500	57	2558	61	4.1	4	1005
PL24A19L15CSO	60	2835 SMD	PCB	4960	2700 - 6500	57	2556	61	4.1	4	1005
PL24A10L15C	66	2835 SMD	PCB	5510	2700 - 6500	57	2840	61	4.5	4	1005
PL24A10L15CSB	66	2835 SMD	PCB	5510	2700 - 6500	57	2838	61	4.5	4	1005
PL24A10L15CSO	66	2835 SMD	PCB	5510	2700 - 6500	57	2836	61	4.5	4	1005

Visible frame width / Largeur de cadre visible: 73mm







**SLIM LINE**



# SLIM LINE

## LED

### Recessed Lighting Fixtures With Diffuser

### Luminaire Encastrés Avec Diffuseur

#### APPLICATION AREAS

Shopping Malls  
Supermarkets  
Offices  
Meeting rooms  
Stores  
Hospitals  
Schools

#### DOMAINES D'UTILISATION

Centres Commerciaux  
Supermarchés  
Bureaux  
Salles de Réunions  
Magasins  
Hopitaux  
Ecoles

#### BODY

White or silver color options aluminum.

#### DIFFUSER

UV stabilized extruded PC diffuser.

#### CONVERTER

Long life, low power loss converter with constant current.  
Compatible with ENEC standards.

#### LED

LED modules with 60.000 hours lifetime LUMILEDS / SAMSUNG / NICHIA brand LEDs.

#### CORPS

Corps en aluminium de couleurs argent et blanc disponibles. Design Elegant.

#### DIFFUSEUR

Diffuseur en PC extrudé stabilisé aux UV.

#### CONVERTEUR

Convertisseur, conforme aux normes ENEC. Longue vie. Perte de puissance faible avec courant constant .

#### LED

Modules LED – Durée de vie 60.000 heures avec LED de marque LUMILEDS / SAMSUNG / NICHIA.

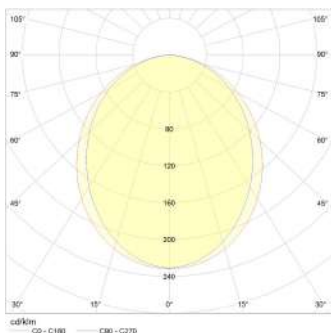

V / Hz      220 - 240 / 50 - 60

Options	Options
Dimmable electronic ballast or convertor.	Ballast électronique dimmable ou converteur.
Emergency kit	Kit d'urgence.

NOTE	NOTE
Given lumen values are net delivered luminaire output lumens.	Les valeurs de lumens données sont les lumens de sortie nets du luminaire.
Given power values are total consumed AC power of the luminaire.	Les valeurs de puissance données sont la puissance AC totale consommée du luminaire.

Color Options  
Options de Couleur



LED Type / Type LED

Color Rendering Index / Indice de Rendu des Couleurs: (CRI): Ra>80

Code	Power Puissance (W)	LED Type Type De LED	LED Module Module LED	Lum. Flux Flux Lum. (lm)	Température De Couleur (K)	Dimensions (mm)			Weight Poids (kg)	Packing Quantity Colisage	Pcs./20" Container Pcs./20" Conteneur
						a	l	h			
PL14A13L15C	21	2835 SMD	PCB	1655	2700 - 6500	62	861	85	1.7	4	2908
PL14A13L25C	30	2835 SMD	PCB	2490	2700 - 6500	62	861	85	1.8	4	2908
PL14A14L15C	26	2835 SMD	PCB	2205	2700 - 6500	62	1141	85	2.1	4	2268
PL14A14L25C	41	2835 SMD	PCB	3320	2700 - 6500	62	1141	85	2.2	4	2268
PL14A15L15C	33	2835 SMD	PCB	2755	2700 - 6500	62	1422	85	2.5	4	1826
PL14A15L15CSB	33	2835 SMD	PCB	2755	2700 - 6500	62	1420	85	2.5	4	1826
PL14A15L15CSO	33	2835 SMD	PCB	2755	2700 - 6500	62	1418	85	2.5	4	1826
PL14A15L25C	51	2835 SMD	PCB	4150	2700 - 6500	62	1422	85	2.6	4	1826
PL14A15L25CSB	51	2835 SMD	PCB	4150	2700 - 6500	62	1420	85	2.6	4	1826
PL14A15L25CSO	51	2835 SMD	PCB	4150	2700 - 6500	62	1418	85	2.6	4	1826
PL14A16L15C	39	2835 SMD	PCB	3305	2700 - 6500	62	1711	85	2.9	4	1576
PL14A16L15CSB	39	2835 SMD	PCB	3305	2700 - 6500	62	1709	85	2.9	4	1576
PL14A16L15CSO	39	2835 SMD	PCB	3305	2700 - 6500	62	1707	85	2.9	4	1576
PL14A16L25C	61	2835 SMD	PCB	4975	2700 - 6500	62	1711	85	3.0	4	1576
PL14A16L25CSB	61	2835 SMD	PCB	4975	2700 - 6500	62	1709	85	3.0	4	1576
PL14A16L25CSO	61	2835 SMD	PCB	4975	2700 - 6500	62	1707	85	3.0	4	1576
PL14A17L15C	47	2835 SMD	PCB	3855	2700 - 6500	62	1999	85	3.3	4	1250
PL14A17L15CSB	47	2835 SMD	PCB	3855	2700 - 6500	62	1997	85	3.3	4	1250
PL14A17L15CSO	47	2835 SMD	PCB	3855	2700 - 6500	62	1995	85	3.3	4	1250
PL14A17L25C	70	2835 SMD	PCB	5805	2700 - 6500	62	1999	85	3.5	4	1250
PL14A17L25CSB	70	2835 SMD	PCB	5805	2700 - 6500	62	1997	85	3.5	4	1250
PL14A17L25CSO	70	2835 SMD	PCB	5805	2700 - 6500	62	1995	85	3.5	4	1250
PL14A18L15C	53	2835 SMD	PCB	4410	2700 - 6500	62	2280	85	3.7	4	1250
PL14A18L15CSB	53	2835 SMD	PCB	4410	2700 - 6500	62	2278	85	3.7	4	1250
PL14A18L15CSO	53	2835 SMD	PCB	4410	2700 - 6500	62	2276	85	3.7	4	1250
PL14A19L15C	60	2835 SMD	PCB	4960	2700 - 6500	62	2560	85	4.1	4	1005
PL14A19L15CSB	60	2835 SMD	PCB	4960	2700 - 6500	62	2558	85	4.1	4	1005
PL14A19L15CSO	60	2835 SMD	PCB	4960	2700 - 6500	62	2556	85	4.1	4	1005
PL14A10L15C	66	2835 SMD	PCB	5510	2700 - 6500	62	2840	85	4.5	4	1005
PL14A10L15CSB	66	2835 SMD	PCB	5510	2700 - 6500	62	2838	85	4.5	4	1005
PL14A10L15CSO	66	2835 SMD	PCB	5510	2700 - 6500	62	2836	85	4.5	4	1005

Visible frame width / Largeur de cadre visible: 72mm

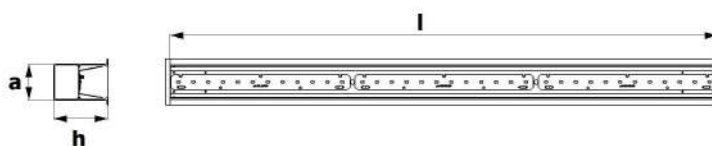



 **pamir**<sup>®</sup>  
aydınlatma



**PROLINE**



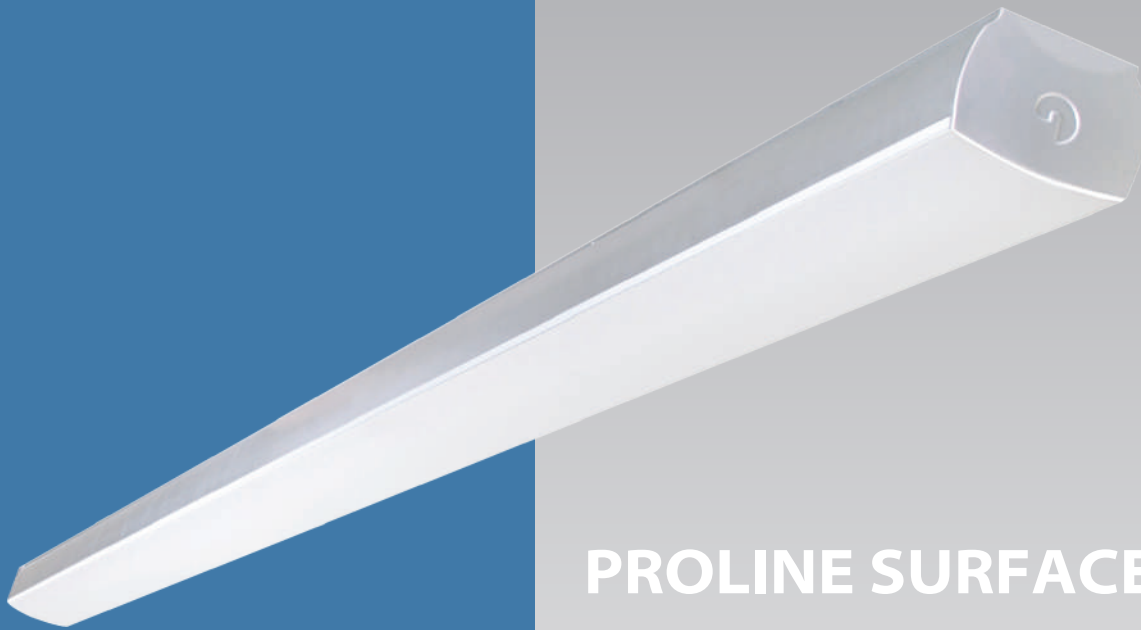

# PROLINE SURFACE

## LED

### Surface Mounted Lighting Fixtures With Diffuser Luminaires Apparents Avec Diffuseur

#### APPLICATION AREAS

Shopping Malls  
Supermarkets  
Offices  
Meeting rooms  
Stores  
Hospitals  
Schools  
Corridors

#### DOMAINES D'UTILISATION

Centres Commerciaux  
Supermarchés  
Bureaux  
Salles de Réunions  
Magasins  
Hopitaux  
Ecoles  
Couloirs

#### BODY

Anodized aluminum with satin finishing, elegant design with silver color.

#### DIFFUSER

UV stabilized extruded PC diffuser.

#### CONVERTER

Long life, low power loss converter with constant current. Compatible with ENEC standards.

#### LED

LED modules with 60.000 hours lifetime LUMILEDS / SAMSUNG / NICHIA brand LEDs.

#### CORPS

Corps en aluminium anodisé, satiné. Design Elegant Couleur Argent.

#### DIFFUSEUR

Diffuseur en PC extrudé stabilisé aux UV.

#### CONVERTEUR

Convertisseur, conforme aux normes ENEC. Longue vie. Perte de puissance faible avec courant constant.

#### LED

Modules LED – Durée de vie 60.000 heures avec LED de marque LUMILEDS / SAMSUNG / NICHIA.

V / Hz 220 - 240 / 50 - 60

Options	Options
 <p><b>Suspension:</b> Composed of 1mm steel wire rope and nickel-plated brass components. Suspension height is adjustable. Supplied with transparent electric cord and ceiling mounted electrical junction box with aesthetic design.</p>	<p><b>Fixation:</b> Comprend un cable en acier de 1 mm et des composants en laiton nickelé. Livré avec un cordon électrique transparent, une boîte de jonction électrique au design esthétique, à fixer au plafond.</p>

Options	Options
Dimmable electronic ballast or convertor. Emergency kit	Ballast électronique dimmable ou convertor. Kit d'urgence.
NOTE	NOTE
Given lumen values are net delivered luminaire output lumens.	Les valeurs de lumens données sont les lumens de sortie nets du luminaire.
Given power values are total consumed AC power of the luminaire.	Les valeurs de puissance données sont la puissance AC totale consommée du luminaire.



## LED Type / Type LED

Color Rendering Index / Indice de Rendu des Couleurs: (CRI): Ra>80

Code	Power Puissance (W)	LED Type Type De LED	LED Module Module LED	Lum. Flux Flux Lum. (lm)	Color Temperature Température De Couleur (K)	Dimensions (mm)			Weight Poids (kg)	Packing Quantity Colisage	Pcs./20" Container Pcs./20" Conteneur
						a	b	h			
PL2U13L15C	21	2835 SMD	PCB	2140	2700 - 6500	98	853	76	1.6	5	3635
PL2U13L25C	30	2835 SMD	PCB	3220	2700 - 6500	98	853	76	1.6	5	3635
PL2U14L15C	26	2835 SMD	PCB	2850	2700 - 6500	98	1133	76	2.2	5	2835
PL2U14L25C	41	2835 SMD	PCB	4290	2700 - 6500	98	1133	76	2.2	5	2835
PL2U15L15C	33	2835 SMD	PCB	3565	2700 - 6500	98	1414	76	2.7	5	2295
PL2U15L15CSB	33	2835 SMD	PCB	3565	2700 - 6500	98	1409	76	2.6	5	2295
PL2U15L25CSO	33	2835 SMD	PCB	3565	2700 - 6500	98	1404	76	2.5	5	2295
PL2U15L25C	51	2835 SMD	PCB	5365	2700 - 6500	98	1414	76	2.7	5	2295
PL2U15L25CSB	51	2835 SMD	PCB	5365	2700 - 6500	98	1409	76	2.6	5	2295
PL2U15L25CSO	51	2835 SMD	PCB	5365	2700 - 6500	98	1404	76	2.5	5	2295
PL2U16L15C	39	2835 SMD	PCB	4275	2700 - 6500	98	1695	76	3.3	5	1970
PL2U16L15CSB	39	2835 SMD	PCB	4275	2700 - 6500	98	1690	76	3.2	5	1970
PL2U16L15CSO	39	2835 SMD	PCB	4275	2700 - 6500	98	1685	76	3.1	5	1970
PL2U16L25C	61	2835 SMD	PCB	6435	2700 - 6500	98	1695	76	3.3	5	1970
PL2U16L25CSB	61	2835 SMD	PCB	6435	2700 - 6500	98	1690	76	3.2	5	1970
PL2U16L25CSO	61	2835 SMD	PCB	6435	2700 - 6500	98	1685	76	3.1	5	1970
PL2U17L15C	47	2835 SMD	PCB	4990	2700 - 6500	98	1976	76	3.8	5	1560
PL2U17L15CSB	47	2835 SMD	PCB	4990	2700 - 6500	98	1971	76	3.7	5	1560
PL2U17L15CSO	47	2835 SMD	PCB	4990	2700 - 6500	98	1966	76	3.6	5	1560
PL2U17L25C	70	2835 SMD	PCB	7510	2700 - 6500	98	1976	76	3.8	5	1560
PL2U17L25CSB	70	2835 SMD	PCB	7510	2700 - 6500	98	1971	76	3.7	5	1560
PL2U17L25CSO	70	2835 SMD	PCB	7510	2700 - 6500	98	1966	76	3.6	5	1560
PL2U18L15C	53	2835 SMD	PCB	5700	2700 - 6500	98	2256	76	4.3	5	1560
PL2U18L15CSB	53	2835 SMD	PCB	5700	2700 - 6500	98	2251	76	4.2	5	1560
PL2U18L15CSO	53	2835 SMD	PCB	5700	2700 - 6500	98	2246	76	4.1	5	1560
PL2U19L15C	60	2835 SMD	PCB	6415	2700 - 6500	98	2536	76	4.8	5	1255
PL2U19L15CSB	60	2835 SMD	PCB	6415	2700 - 6500	98	2531	76	4.7	5	1255
PL2U19L15CSO	60	2835 SMD	PCB	6415	2700 - 6500	98	2526	76	4.6	5	1255
PL2U10L15C	66	2835 SMD	PCB	7125	2700 - 6500	98	2816	76	5.3	5	1255
PL2U10L15CSB	66	2835 SMD	PCB	7125	2700 - 6500	98	2811	76	5.2	5	1255
PL2U10L15CSO	66	2835 SMD	PCB	7125	2700 - 6500	98	2806	76	5.1	5	1255

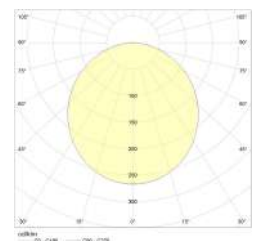



# PROLINE RECESSED

## LED

### Recessed Lighting Fixtures With Diffuser

### Luminaire Encastrés Avec Diffuseur

#### APPLICATION AREAS

Shopping Malls  
Supermarkets  
Offices  
Meeting rooms  
Stores  
Hospitals  
Schools  
Corridors

#### DOMAINES D'UTILISATION

Centres Commerciaux  
Supermarchés  
Bureaux  
Salles de Réunions  
Magasins  
Hopitaux  
Ecoles  
Couloirs

#### BODY

Anodized aluminum with satin finishing, elegant design with silver and white color.

#### DIFFUSER

UV stabilized extruded PC diffuser.

#### CONVERTER

Long life, low power loss converter with constant current. Compatible with ENEC standards.

#### LED

LED modules with 60.000 hours lifetime LUMILEDS / SAMSUNG / NICHIA brand LEDs.

#### CORPS

Corps couleur argent et blanc en aluminium anodisé et satiné . Design élégant.~

#### DIFFUSEUR

Diffuseur en PC extrudé stabilisé aux UV..

#### CONVERTEUR

Convertisseur, conforme aux normes ENEC. Longue vie. Perte de puissance faible avec courant constant .

#### LED

Modules LED – Durée de vie 60.000 heures avec LED de marque LUMILEDS / SAMSUNG / NICHIA.

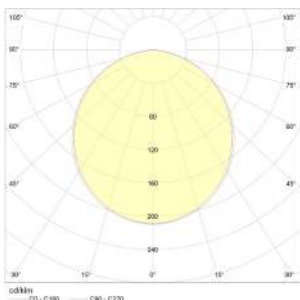

V / Hz 220 - 240 / 50 - 60

Options	Options
Dimmable electronic ballast or convertor.	Ballast électronique dimmable ou converteur.
Emergency kit	Kit d'urgence.

NOTE	NOTE
Given lumen values are net delivered luminaire output lumens.	Les valeurs de lumens données sont les lumens de sortie nets du luminaire.
Given power values are total consumed AC power of the luminaire.	Les valeurs de puissance données sont la puissance AC totale consommée du luminaire.

Color Options  
Options de Couleur



LED Type / Type LED

Color Rendering Index / Indice de Rendu des Couleurs: (CRI): Ra>80

Code	Power Puissance (W)	LED Type Type De LED	LED Module Module LED	Lum. Flux Flux Lum. (lm)	Color Temperature Température De Couleur (K)	Dimensions (mm)			Weight Poids (kg)	Packing Quantity Colisage	Pcs./20" Container Pcs./20" Conteneur
						a	b	h			
PL2A13L15C	21	2835 SMD	PCB	1710	2700 - 6500	92	861	85	1.7	5	3635
PL2A13L25C	30	2835 SMD	PCB	2575	2700 - 6500	92	861	85	1.7	5	3635
PL2A14L15C	26	2835 SMD	PCB	2280	2700 - 6500	92	1141	85	2.3	5	2835
PL2A14L25C	41	2835 SMD	PCB	3435	2700 - 6500	92	1141	85	2.3	5	2835
PL2A15L15C	33	2835 SMD	PCB	2850	2700 - 6500	92	1422	85	2.8	5	2295
PL2A15L15CSB	33	2835 SMD	PCB	2850	2700 - 6500	92	1422	85	2.7	5	2295
PL2A15L15CSO	33	2835 SMD	PCB	2850	2700 - 6500	92	1418	85	2.6	5	2295
PL2A15L25C	51	2835 SMD	PCB	4290	2700 - 6500	92	1422	85	2.8	5	2295
PL2A15L25CSB	51	2835 SMD	PCB	4290	2700 - 6500	92	1420	85	2.7	5	2295
PL2A15L25CSO	51	2835 SMD	PCB	4290	2700 - 6500	92	1418	85	2.6	5	2295
PL2A16L15C	39	2835 SMD	PCB	3420	2700 - 6500	92	1711	85	3.4	5	1970
PL2A16L15CSB	39	2835 SMD	PCB	3420	2700 - 6500	92	1709	85	3.3	5	1970
PL2A16L15CSO	39	2835 SMD	PCB	3420	2700 - 6500	92	1707	85	3.2	5	1970
PL2A16L25C	61	2835 SMD	PCB	5150	2700 - 6500	92	1711	85	3.4	5	1970
PL2A16L25CSB	61	2835 SMD	PCB	5150	2700 - 6500	92	1709	85	3.3	5	1970
PL2A16L25CSO	61	2835 SMD	PCB	5150	2700 - 6500	92	1707	85	3.2	5	1970
PL2A17L15C	47	2835 SMD	PCB	3990	2700 - 6500	92	1999	85	3.9	5	1560
PL2A17L15CSB	47	2835 SMD	PCB	3990	2700 - 6500	92	1997	85	3.8	5	1560
PL2A17L15CSO	47	2835 SMD	PCB	3990	2700 - 6500	92	1995	85	3.7	5	1560
PL2A17L25C	70	2835 SMD	PCB	6010	2700 - 6500	92	1999	85	3.9	5	1560
PL2A17L25CSB	70	2835 SMD	PCB	6010	2700 - 6500	92	1997	85	3.8	5	1560
PL2A17L25CSO	70	2835 SMD	PCB	6010	2700 - 6500	92	1995	85	3.7	5	1560
PL2A18L15C	53	2835 SMD	PCB	4560	2700 - 6500	92	2280	85	4.4	5	1560
PL2A18L15CSB	53	2835 SMD	PCB	4560	2700 - 6500	92	2278	85	4.3	5	1560
PL2A18L15CSO	53	2835 SMD	PCB	4560	2700 - 6500	92	2276	85	4.2	5	1560
PL2A19L15C	60	2835 SMD	PCB	5130	2700 - 6500	92	2560	85	4.9	5	1255
PL2A19L15CSB	60	2835 SMD	PCB	5130	2700 - 6500	92	2558	85	4.8	5	1255
PL2A19L15CSO	60	2835 SMD	PCB	5130	2700 - 6500	92	2556	85	4.7	5	1255
PL2A10L15C	66	2835 SMD	PCB	5700	2700 - 6500	92	2840	85	5.4	5	1255
PL2A10L15CSB	66	2835 SMD	PCB	5700	2700 - 6500	92	2838	85	5.3	5	1255
PL2A10L15CSO	66	2835 SMD	PCB	5700	2700 - 6500	92	2836	85	5.2	5	1255

Visible frame width / Largeur de cadre visible: 108mm

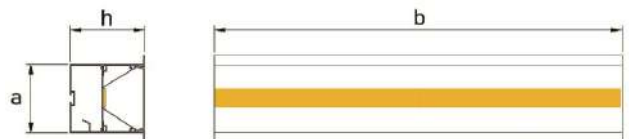



 **pamir**<sup>®</sup>  
aydınlatma





**WALLWASHER**



## WALLWASHER

### LED

#### Wall Washer With Lens

#### Lèche-Mur Avec Lentille

#### APPLICATION AREAS

Tunnels  
Warehouses  
Factories  
Sport Areas  
Outdoor Lighting  
Open-air Car Park

#### DOMAINES D'UTILISATION

Tunnels  
Hangars de Stockage  
Usines  
Complexes Sportifs  
Espaces Extérieurs  
Parking en Plein Air

#### BODY

High-resistance body against harsh natural conditions with 20 micron electrical coating.

#### LENS

Lenses with wide variety of light distribution angle options and high light transparency. (15° / 30° / 60°)

#### CONVERTER

Converter compatible with ENEC standards.

#### LED

LED modules with 60.000 hours lifetime CREE / SAMSUNG / NICHIA brand LEDs.

#### CORPS

Corps à haute résistance contre les conditions naturelles difficiles avec revêtement électrique de 20 microns..

#### LENS

Lentilles avec une grande variété d'options d'angle de distribution de lumière, et transparence de grande. (15° / 30° / 60°)

#### CONVERTEUR

Convertisseur, conforme aux normes ENEC.

#### LED

Modules LED – Durée de vie 60.000 heures avec LED de marque CREE / SAMSUNG / NICHIA.



3000K / 4000K / 6500K

Color Rendering Index / Indice de Rendu des Couleurs: (CRI): Ra>70

Code	Power Puissance (W)	Led Type Type De Led	Lum. Flux Flux Lum. (lm)	Color Temperature Température de couleur(K)	Dimensions (mm) l h	Weight Poids (kg)	Packing Quantity Colisage	Pcs./20" Container Pcs./20" Conteneur
EALW11U	11	Power Led	900	3000 - 4000 - 6500	173 180	0,7	1	741
EALW20U	20	Power Led	1900	3000 - 4000 - 6500	329 180	1,1	1	417
EALW38U	38	Power Led	3600	3000 - 4000 - 6500	614 180	1,8	1	231
EALW54U	54	Power Led	4800	3000 - 4000 - 6500	914 180	2,8	1	157
EALW64U	64	Power Led	6250	3000 - 4000 - 6500	1064 180	3,0	1	136
EALW76U	76	Power Led	7000	3000 - 4000 - 6500	1214 180	3,5	1	119

Red-Blue-Green-Amber / Rouge-Bleu-Vert-Ambre

Color Rendering Index / Indice de Rendu des Couleurs: (CRI): Ra>70

Code	Power Puissance (W)	Led Type Type De Led	Color Temperature Température de couleur(K)	Dimensions (mm) l h	Weight Poids (kg)	Packing Quantity Colisage	Pcs./20" Container Pcs./20" Conteneur
EALWA9U	9	Power Led	Red-Blue-Green-Amber	173 180	0,7	1	741
EALWA16U	16	Power Led	Red-Blue-Green-Amber	329 180	1,1	1	417
EALWA30U	30	Power Led	Red-Blue-Green-Amber	614 180	1,8	1	231
EALWA46U	46	Power Led	Red-Blue-Green-Amber	914 180	2,8	1	157
EALWA52U	52	Power Led	Red-Blue-Green-Amber	1064 180	3,0	1	136
EALWA60U	60	Power Led	Red-Blue-Green-Amber	1214 180	3,5	1	119

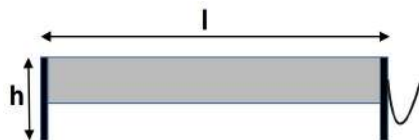

15° Lens

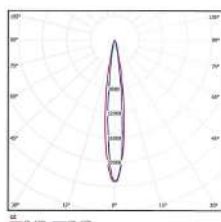

30° Lens

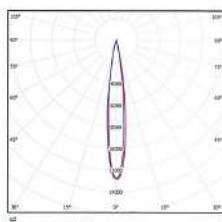

60° Lens

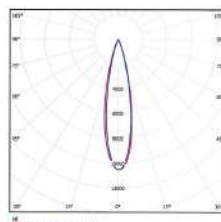

V / Hz 220 - 240 / 50 - 60

Options	Options
Dimmable electronic ballast or convertor.	Ballast électronique dimmable ou converteur.
Emergency kit	Kit d'urgence.

NOTE	NOTE
Given lumen values are net delivered luminaire output lumens.	Les valeurs de lumens données sont les lumens de sortie nets du luminaire.
Given power values are total consumed AC power of the luminaire.	Les valeurs de puissance données sont la puissance AC totale consommée du luminaire.





 **pamir**<sup>®</sup>  
aydinlatma



**RADIANT**





## RADIANT ROUND

### LED

#### Flood Light With Lens

#### Projecteur Avec Lentille

#### APPLICATION AREAS

Tunnels  
Warehouses  
Factories  
Sport Areas  
Outdoor Lighting  
Open-air Car Park

#### DOMAINES D'UTILISATION

Tunnels  
Hangars de Stockage  
Usines  
Complexes Sportifs  
Espaces Exterieurs  
Parking en Plein Air

#### BODY

Black colored aluminum body with effective cooling performance.

#### LENS

Lenses with wide variety of light distribution angle options and high light transparency. Innovative highbay solution for UGR<19.

#### CONVERTER

IP67 converter compatible with ENEC standards.

#### LED

LED modules with 60.000 hours lifetime LUMILEDS / SAMSUNG / NICHIA brand LEDs.

#### CORPS

Corps en aluminium de couleur noire avec des performances de refroidissement efficaces.

#### DIFFUSEUR

Lentilles avec une grande variété d'options d'angle de distribution de lumière, et transparence de grande. Solution innovante de grande hauteur pour UGR<19.

#### CONVERTEUR

IP67 converteur, conforme aux normes ENEC.

#### LED

Modules LED – Durée de vie 60.000 heures avec LED de marque LUMILEDS / SAMSUNG / NICHIA.



Fixed Type / Type Fixes

Color Rendering Index / Indice de Rendu des Couleurs: (CRI): Ra>70

Code	Power Puissance (W)	Led Type Type De Led	Lum. Flux Flux Lum. (lm)	Color Temperature Température de couleur(K)	Dimensions (mm) b h	Weight Poids (kg)	Packing Quantity Colisage	Pcs./20" Container Pcs./20" Conteneur
EALP0110C	110	POWERLED	14845	2700 - 6500	330 87	6.8	1	2020
EALP0150C	150	POWERLED	19250	2700 - 6500	330 87	6.8	1	2020

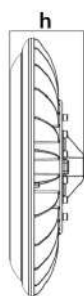
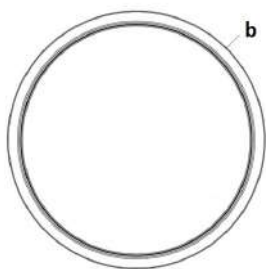

60° Lens

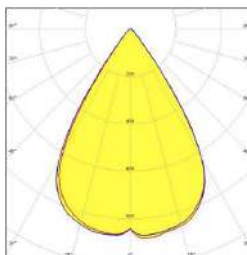

90° Lens

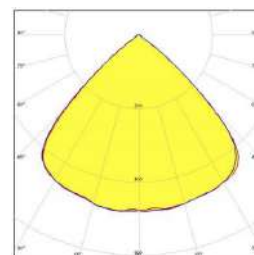

V / Hz 220 - 240 / 50 - 60

Options	Options
Dimmable electronic ballast or convertor. Emergency kit	Ballast électronique dimmable ou converteur. Kit d'urgence.

NOTE	NOTE
Given lumen values are net delivered luminaire output lumens.	Les valeurs de lumens données sont les lumens de sortie nets du luminaire.
Given power values are total consumed AC power of the luminaire.	Les valeurs de puissance données sont la puissance AC totale consommée du luminaire.



## RADIANT AIR

### LED

#### Street Light With Lens

#### Réverbère Avec Lentille

#### APPLICATION AREAS

Tunnels  
Warehouses  
Factories  
Sport Areas  
Outdoor Lighting  
Open-air Car Park  
Street  
Park Area  
Gardens

#### DOMAINES D'UTILISATION

Tunnels  
Hangars de Stockage  
Usines  
Complexes Sportifs  
Espaces Extérieurs  
Parking en Plein Air  
De Rue  
Zone Du Parc  
Les Jardins

#### BODY

Silver colored aluminum body with effective cooling performance.

#### LENS

Lenses with wide variety of light distribution angle options and high light transparency.

#### CONVERTER

IP67 converter compatible with ENEC standards.

#### LED

LED modules with 60.000 hours lifetime LUMILEDS / OSRAM / NICHIA brand LEDs.

#### CORPS

Corps en aluminium de couleur argent avec des performances de refroidissement efficaces.

#### DIFFUSEUR

Lentilles avec une grande variété d'options d'angle de distribution de lumière, et transparence de grande.

#### CONVERTEUR

IP67 converteur, conforme aux normes ENEC.

#### LED

Modules LED – Durée de vie 60.000 heures avec LED de marque LUMILEDS / OSRAM / NICHIA.



Fixed Type / Type Fixes

Color Rendering Index / Indice de Rendu des Couleurs: (CRI): Ra>70

Code	Power Puissance (W)	Led Type Type De Led	Lum. Flux Flux Lum. (lm)	Color Temperature Température de couleur(K)	Dimensions (mm) l h	Weight Poids (kg)	Packing Quantity Colisage	Pcs./20" Container Pcs./20" Conteneur
EALS11U	42	POWERLED	5490	2700 - 6500	346 64	6.8	1	2020
EALS12U	84	POWERLED	10970	2700 - 6500	580 64	6.8	1	2020

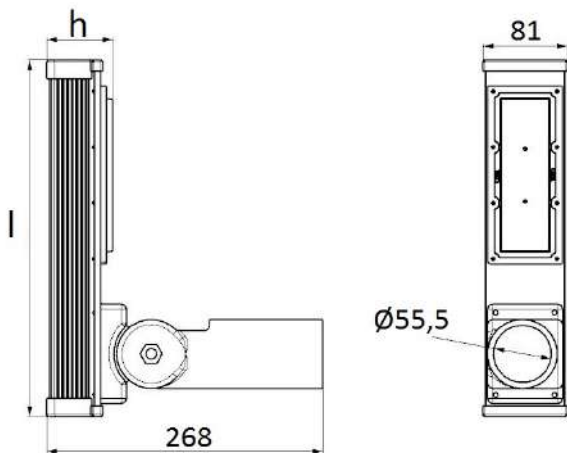

V / Hz 220 - 240 / 50 - 60

Options	Options
Dimmable electronic ballast or convertor. Emergency kit	Ballast électronique dimmable ou converteur. Kit d'urgence.

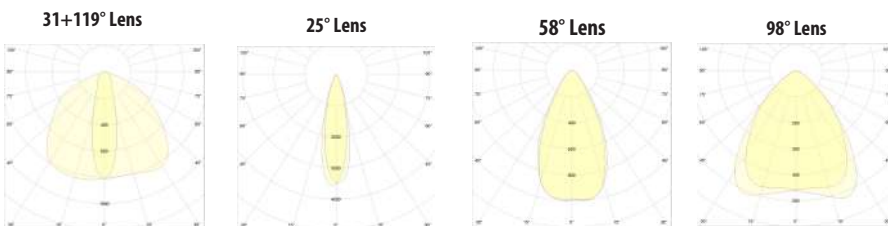

NOTE	NOTE
Given lumen values are net delivered luminaire output lumens.	Les valeurs de lumens données sont les lumens de sortie nets du luminaire.
Given power values are total consumed AC power of the luminaire.	Les valeurs de puissance données sont la puissance AC totale consommée du luminaire.



## RADIANT

# LED

## Flood Light With Lens

## Projecteur Avec Lentille

### APPLICATION AREAS

Tunnels  
Warehouses  
Factories  
Sport Areas  
Outdoor Lighting  
Open-air Car Park

### DOMAINES D'UTILISATION

Tunnels  
Hangars de Stockage  
Usines  
Complexes Sportifs  
Espaces Exterieurs  
Parking en Plein Air

### BODY

Silver colored aluminum body with 15° - 30° rotating modules and effective cooling performance. (Rotating modules are valid for only rotating type)

### LENS

Lenses with wide variety of light distribution angle options and high light transparency.

### CONVERTER

IP67 converter compatible with ENEC standards.

### LED

LED modules with 60.000 hours lifetime LUMILEDS / OSRAM / NICHIA brand LEDs.

### CORPS

Corps en aluminum tournant module de 15° - 30° en couleur argent avec performance de refroidissement efficaces. (Les modules rotatifs ne sont valables que pour le type rotatif)

### DIFFUSEUR

Lentilles avec une grande variété d'options d'angle de distribution de lumière, et transparence de grande.

### CONVERTEUR

IP67 converteur, conforme aux normes ENEC.

### LED

Modules LED – Durée de vie 60.000 heures avec LED de marque LUMILEDS / OSRAM / NICHIA.

V / Hz		220 - 240 / 50 - 60	
Options	Options	NOTE	NOTE
Dimmable electronic ballast or convertor. Emergency kit	Ballast électronique dimmable ou converteur. Kit d'urgence.	Given lumen values are net delivered luminaire output lumens.  Given power values are total consumed AC power of the luminaire.	Les valeurs de lumens données sont les lumens de sortie nets du luminaire.  Les valeurs de puissance données sont la puissance AC totale consommée du luminaire.



### Fixed Type / Type Fixes

Color Rendering Index / Indice de Rendu des Couleurs: (CRI): Ra>70

Code	Power Puissance (W)	Led Type Type De Led	Lum. Flux Flux Lum. (lm)	Color Temperature Température de couleur(K)	Dimensions (mm)			Weight Poids (kg)	Packing Quantity Colisage	Pcs./20" Container Pcs./20" Conteneur
					a	b	h			
EALPS11U	42	POWERLED	5490	2700 - 6500	85	220	117	2,3	1	4618
EALPS21U	84	POWERLED	10970	2700 - 6500	188	240	144	4,8	1	2131
EALPS31U	126	POWERLED	16460	2700 - 6500	287	240	142	5,7	1	1504
EALPS41U	168	POWERLED	21960	2700 - 6500	385	240	146	7,4	1	1162
EALPS51U	210	POWERLED	27450	2700 - 6500	485	240	152	9,2	1	900

### Rotating Type / Type Tournant

Code	Power Puissance (W)	Led Type Type De Led	Lum. Flux Flux Lum. (lm)	Color Temperature Température de couleur(K)	Dimensions (mm)			Weight Poids (kg)	Packing Quantity Colisage	Pcs./20" Container Pcs./20" Conteneur
					a	b	h			
EALPH21U	84	POWERLED	10970	2700 - 6500	188	240	144	4,8	1	2131
EALPH31U	126	POWERLED	16460	2700 - 6500	287	240	142	5,7	1	1504
EALPH41U	168	POWERLED	21960	2700 - 6500	385	240	146	7,4	1	1162
EALPH51U	210	POWERLED	27450	2700 - 6500	485	240	152	9,2	1	900



Rotating Module / Module Tournant

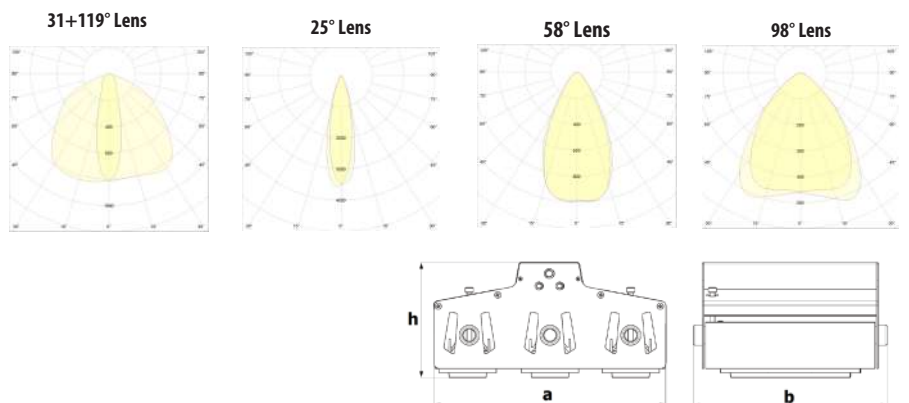





## RADIANT

### LED

#### High Bay Lighting Fixtures With Lens

#### Luminaire Grande Hauteur Avec Lentille

#### APPLICATION AREAS

Tunnels  
Warehouses  
Factories  
Sport Areas  
Outdoor Lighting  
Open-air Car Park

#### DOMAINES D'UTILISATION

Tunnels  
Hangars de Stockage  
Usines  
Complexes Sportifs  
Espaces Exterieurs  
Parking en Plein Air

#### BODY

Silver colored aluminum body with 15° - 30° rotating modules and effective cooling performance. (Rotating modules are valid for only rotating type)

#### LENS

Lenses with wide variety of light distribution angle options and high light transparency.

#### CONVERTER

IP67 converter compatible with ENEC standards.

#### LED

LED modules with 60.000 hours lifetime LUMILEDS / OSRAM / NICHIA brand LEDs.

#### CORPS

Corps en aluminum tournant module de 15° - 30° en couleur argent avec performance de refroidissement efficaces. (Les modules rotatifs ne sont valables que pour le type rotatif)

#### DIFFUSEUR

Lentilles avec une grande variété d'options d'angle de distribution de lumière, et transparence de grande.

#### CONVERTEUR

IP67 converteur, conforme aux normes ENEC.

#### LED

Modules LED – Durée de vie 60.000 heures avec LED de marque LUMILEDS / OSRAM / NICHIA.

V / Hz		220 - 240 / 50 - 60	
Options	Options	NOTE	NOTE
Dimmable electronic ballast or convertor. Emergency kit	Ballast électronique dimmable ou converteur. Kit d'urgence.	Given lumen values are net delivered luminaire output lumens.  Given power values are total consumed AC power of the luminaire.	Les valeurs de lumens données sont les lumens de sortie nets du luminaire.  Les valeurs de puissance données sont la puissance AC totale consommée du luminaire.



### Fixed Type / Type Fixes

Color Rendering Index / Indice de Rendu des Couleurs: (CRI): Ra>70

Code	Power Puissance (W)	Led Type Type De Led	Lum. Flux Flux Lum. (lm)	Color Temperature Température de couleur(K)	Dimensions (mm)			Weight Poids (kg)	Packing Quantity Colisage	Pcs./20" Container Pcs./20" Conteneur
					a	b	h			
EALYS13U	126	POWERLED	16460	2700 - 6500	85	730	142	5,6	1	1358
EALYS14U	168	POWERLED	21960	2700 - 6500	85	958	142	6,2	1	1049
EALYS15U	210	POWERLED	27450	2700 - 6500	85	1192	142	10,0	1	847
EALYS23U	252	POWERLED	32940	2700 - 6500	188	823	142	11,2	1	782
EALYS24U	336	POWERLED	38430	2700 - 6500	188	958	142	12,4	1	612

### Rotating Type / Type Tournant

Code	Power Puissance (W)	Led Type Type De Led	Lum. Flux Flux Lum. (lm)	Color Temperature Température de couleur(K)	Dimensions (mm)			Weight Poids (kg)	Packing Quantity Colisage	Pcs./20" Container Pcs./20" Conteneur
					a	b	h			
EALYH13U	126	POWERLED	16460	2700 - 6500	85	690	142	6,2	1	1432
EALYH14U	168	POWERLED	21960	2700 - 6500	85	914	142	6,9	1	1092
EALYH15U	210	POWERLED	27450	2700 - 6500	85	1236	142	7,5	1	821



Rotating Module / Module Tournant

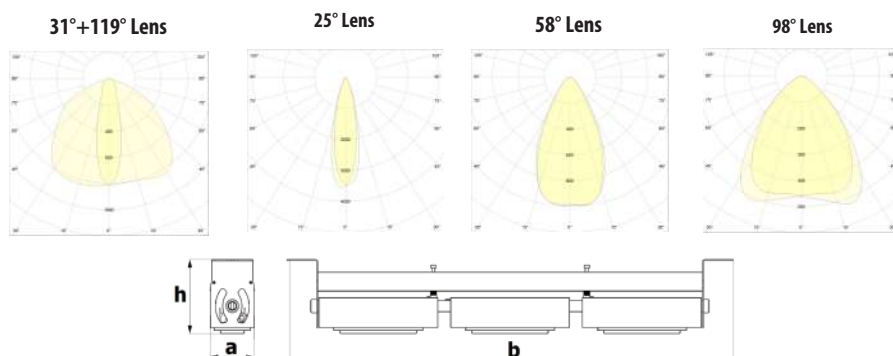



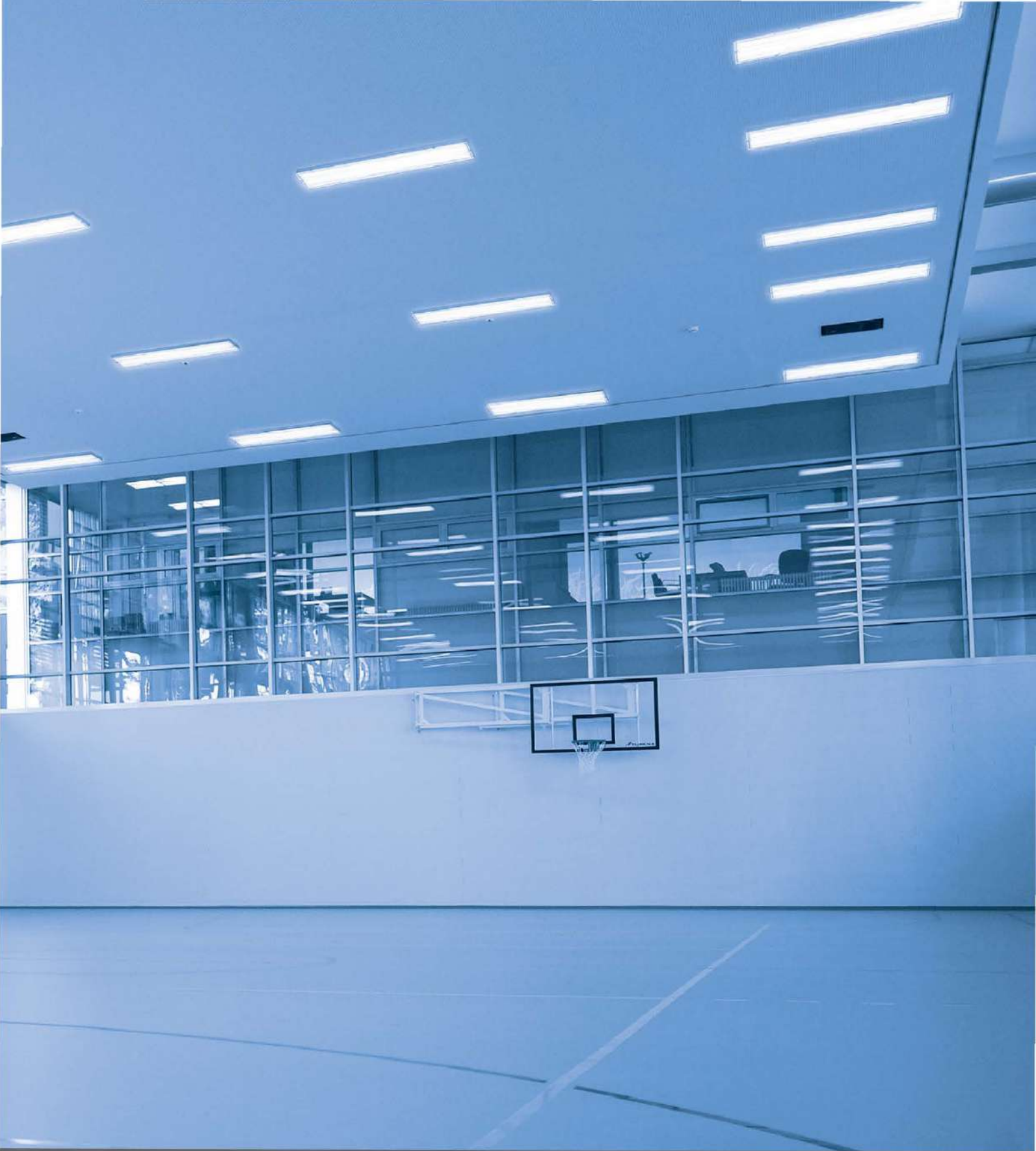

**INDUSTRIAL / INDUSTRIEL**



# INDUSTRIAL HIGH BAY

## LED / T16 (T5)

2X High Bay Lighting Fixtures

Luminaire Grande Hauteur 2X

### APPLICATION AREAS

Factories  
Supermarkets  
Warehouses  
Stations  
Subways and Tunnels  
Sport Halls  
Indoor Swimming  
Pools

### DOMAINES D'UTILISATION

Usines  
Supermarchés  
Hangars de stockage  
Gares  
Tunnels - Métros  
Complexes sportifs  
Piscines couvertes

#### BODY

RAL 9016 electrostatic powder coated sheet-metal.

#### GLASS

4mm tempered glass (with certificate).

#### REFLECTOR

Anodized aluminum with %99,9 purity and with mirror like glossy surface having high reflection performance and design enabling the efficient distribution of the light to the targeted area.

#### BALLAST (For T5 Models)

Electronic ballast with long life, low power loss EEI = A2 and constant flux. Compatible with ENEC standards.

#### CONVERTER (For LED Models)

Long life, low power loss converter with constant current. Compatible with ENEC standards.

#### LED (For LED Models)

LED modules with 60.000 hours lifetime LUMILEDS / SAMSUNG / NICHIA brand LEDs.

#### SEAL

Thermoplastic elastomer.

#### GLASS HOLDER LATCHES

Aluminum.

#### CORPS

RAL 9016 Feuille de métal peinte électrostatiquement .

#### VERRE

4 mm verre trempé (avec certificat).

#### REFLECTEUR

En aluminium anodisé à 99,99% de pureté et avec une surface brillante comme un miroir , assurant un niveau élevé de réflexion. Design élégant. Permet une répartition efficace de la lumière vers l'endroit ciblé.

#### BALLAST (Pour T5 Modèles)

Ballast électronique , conforme aux normes ENEC. Longue vie. Perte de puissance faible (EEI=A2). Flux de lumière régulier.

#### CONVERTEUR (Pour Modèles LED)

Convertisseur, conforme aux normes ENEC. Longue vie. Perte de puissance faible avec cou-rant constant .

#### LED (Pour Modèles LED)

Modules LED – Durée de vie 60.000 heures avec LED de marque LUMILEDS / SAMSUNG / NICHIA.

#### JOINT

Elastomère thermoplastique.

#### CLAPETS DE MAINTIEN DU VERRE

Aluminium.



### LED Type / Type LED

Color Rendering Index / Indice de Rendu des Couleurs: (CRI): Ra>80

Code	Power Puissance (W)	LED Type Type De LED	LED Module Module LED	Lum. Flux Flux Lum. (lm)	Color Temperature Température De Couleur (K)	Dimensions (mm)			Weight Poids (kg)	Packing Quantity Colisage	Pcs./20" Container Pcs./20" Conteneur
						a	b	h			
EAL1U24L25C	80	2835 SMD	PCB	10180	2700 - 6500	225	1200	70	7.5	1	440
EAL1U25L25C	100	2835 SMD	PCB	12720	2700 - 6500	225	1500	70	9.0	1	357

### T5 Fluorescent Type / Type T5 Fluorescent

Code	Power Puissance (W)	Lamp Type Type De Lampe	Socket Type Type De Douille	Lum. Flux Flux Lum. (lm)	Current Courant (A)	Dimensions (mm)			Weight Poids (kg)	Packing Quantity Colisage	Pcs./20" Container Pcs./20" Conteneur
						a	b	h			
EA51U254C	2x54	T16(T5)	G5	8900	0.50	225	1200	70	7.5	1	440
EA51U280C	2x80	T16(T5)	G5	12300	0.76	225	1500	70	9.0	1	357

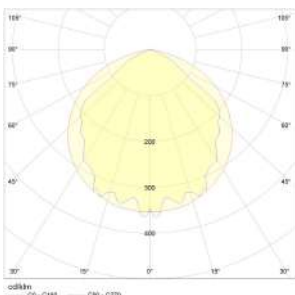
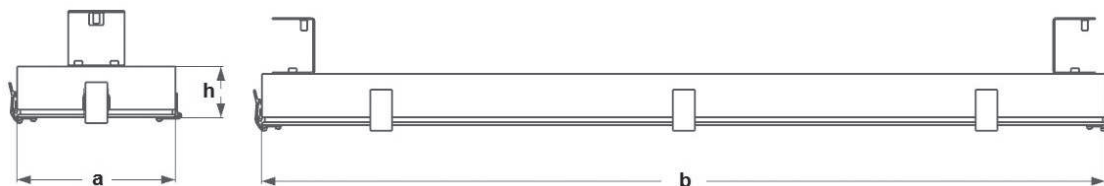

LED

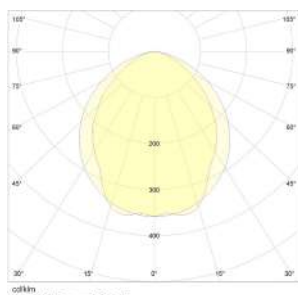

T5

V / Hz 220 - 240 / 50 - 60

Options	Options
Dimmable electronic ballast or convertor. Emergency kit	Ballast électronique dimmable ou converteur. Kit d'urgence.
NOTE	NOTE
Given lumen values are net delivered luminaire output lumens.	Les valeurs de lumens données sont les lumens de sortie nets du luminaire.
Given power values are total consumed AC power of the luminaire.	Les valeurs de puissance données sont la puissance AC totale consommée du luminaire.



# INDUSTRIAL HIGH BAY

## LED / T16 (T5)

4X High Bay Lighting Fixtures

Luminaire Grande Hauteur 4X

### APPLICATION AREAS

Factories  
Supermarkets  
Warehouses  
Stations  
Subways and Tunnels  
Sport Halls  
Indoor Swimming  
Pools

### DOMAINES D'UTILISATION

Usines  
Supermarchés  
Hangars de stockage  
Gares  
Tunnels - Métros  
Complexes sportifs  
Piscines couvertes

#### BODY

RAL 9016 electrostatic powder coated sheet-metal.

#### GLASS

4mm tempered glass (with certificate).

#### REFLECTOR

Anodized aluminum with %99,9 purity and with mirror like glossy surface having high reflection performance and design enabling the efficient distribution of the light to the targeted area.

#### BALLAST (For T5 Models)

Electronic ballast with long life, low power loss EEI = A2 and constant flux. Compatible with ENEC standards.

#### CONVERTER (For LED Models)

Long life, low power loss converter with constant current. Compatible with ENEC standards.

#### LED (For LED Models)

LED modules with 60.000 hours lifetime LUMILEDS / SAMSUNG / NICHIA brand LEDs.

#### SEAL

Thermoplastic elastomer.

#### GLASS HOLDER LATCHES

Aluminum.

#### CORPS

RAL 9016 Feuille de métal peinte électrostatiquement .

#### VERRE

4 mm verre trempé (avec certificat).

#### REFLECTEUR

En aluminium anodisé à 99,99% de pureté et avec une surface brillante comme un miroir , assurant un niveau élevé de réflexion. Design élégant. Permet une répartition efficace de la lumière vers l'endroit ciblé.

#### BALLAST (Pour T5 Modèles)

Ballast électronique , conforme aux normes ENEC. Longue vie. Perte de puissance faible (EEI=A2). Flux de lumière régulier.

#### CONVERTEUR (Pour Modèles LED)

Convertisseur, conforme aux normes ENEC. Longue vie. Perte de puissance faible avec courant constant .

#### LED (Pour Modèles LED)

Modules LED – Durée de vie 60.000 heures avec LED de marque LUMILEDS / SAMSUNG / NICHIA.

#### JOINT

Elastomère thermoplastique.

#### CLAPETS DE MAINTIEN DU VERRE

Aluminium.



### LED Type / Type LED

Color Rendering Index / Indice de Rendu des Couleurs: (CRI): Ra>80

Code	Power Puissance (W)	LED Type Type De LED	LED Module Module LED	Lum. Flux Flux Lum. (lm)	Color Temperature Température De Couleur (K)	Dimensions (mm)			Weight Poids (kg)	Packing Quantity Colisage	Pcs./20" Container Pcs./20" Conteneur
						a	b	h			
EAL1U44L25C	160	2835 SMD	PCB	20360	2700 - 6500	415	1200	70	12.1	1	450
EAL1U45L25C	200	2835 SMD	PCB	25450	2700 - 6500	415	1500	70	15.1	1	360

### T5 Fluorescent Type / Type T5 Fluorescent

Code	Power Puissance (W)	Lamp Type Type De Lampe	Socket Type Type De Douille	Lum. Flux Flux Lum. (lm)	Current Courant (A)	Dimensions (mm)			Weight Poids (kg)	Packing Quantity Colisage	Pcs./20" Container Pcs./20" Conteneur
						a	b	h			
EA51U454C	4x54	T16(T5)	G5	17800	1.00	415	1200	70	12.1	1	450
EA51U480C	4x80	T16(T5)	G5	24600	1.52	415	1500	70	15.1	1	360

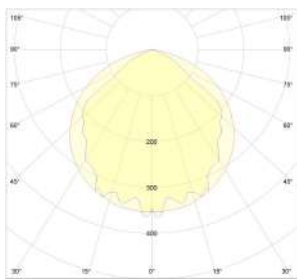
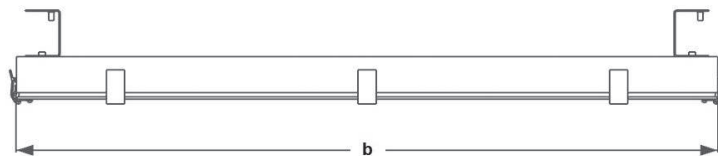
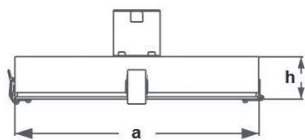

LED

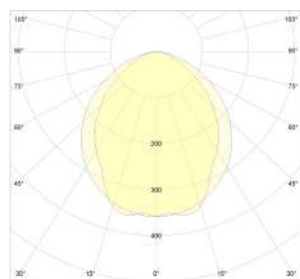

T5

V / Hz 220 - 240 / 50 - 60

Options	Options
Dimmable electronic ballast or convertor. Emergency kit	Ballast électronique dimmable ou convertor. Kit d'urgence.
<b>NOTE</b> Given lumen values are net delivered luminaire output lumens.	<b>NOTE</b> Les valeurs de lumens données sont les lumens de sortie nets du luminaire.
Given power values are total consumed AC power of the luminaire.	Les valeurs de puissance données sont la puissance AC totale consommée du luminaire.







**WATERPROOF / ETANCHE**

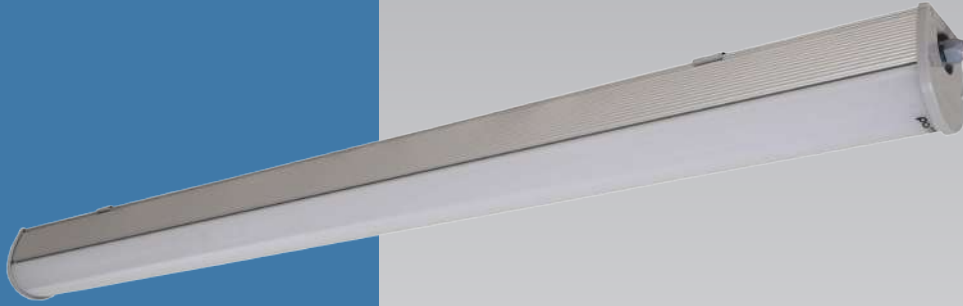

# ALUMINUM WATERPROOF D'ALUMINUM ETANCHE

## LED

### Aluminum Waterproof Lighting Fixtures

### Luminaire Etanches D'aluminium

#### APPLICATION AREAS

Factories  
Industrial Kitchens  
Laundries  
Parking Areas  
Outdoor Areas  
Tunnels

#### DOMAINES D'UTILISATION

Usines  
Cuisines Industrielles  
Blanchisseries  
Parkings  
Espaces Exterieurs  
Tunnels

#### BODY

Aluminum extrusion and corrosion resistant body.

#### DIFFUSER

UV stabilized extruded PC diffuser.

#### CEILING FIXING BRACE

Stainless steel sheet metal with 0.5 mm thickness.

#### CONVERTER

Long life, low power loss converter with constant current. Compatible with ENEC standards.

#### LED

LED modules with 60.000 hours lifetime SEOUL / LUMILEDS / NICHIA brand LEDs.

#### CORPS

Extrusion en aluminium et corps résistant à la corrosion.

#### DIFFUSEUR

Diffuseur en PC extrudé stabilisé aux UV.

#### ACCOLADE DE FIXATION AU PLAFOND

Feuille d'acier inoxydable de 0.5 mm d'épaisseur.

#### CONVERTEUR

Convertisseur, conforme aux normes ENEC. Longue vie. Perte de puissance faible avec courant constant.

#### LED

Modules LED – Durée de vie 60.000 heures avec LED de marque SEOUL / LUMILEDS / NICHIA.



## LED Type / Type LED

Color Rendering Index / Indice de Rendu des Couleurs: (CRI): Ra>80

Code	Power Puissance (W)	LED Type Type De LED	LED Module Module LED	Lum. Flux Flux Lum. (lm)	Color Temperature Température De Couleur (K)	Dimensions (mm)			Weight Poids (kg)	Packing Quantity Colisage	Pcs./20" Container Pcs./20" Conteneur
						a	b	h			
EALAE11T03	15	2835 SMD	PCB	1300	2700 - 6500	77	560	82	1.2	9	3480
EALAE21T03	29	2835 SMD	PCB	2600	2700 - 6500	77	560	82	1.3	9	3480
EALAE21T04	36	2835 SMD	PCB	3155	2700 - 6500	77	560	82	1.6	9	3480
EALAE31T03	42	2835 SMD	PCB	3900	2700 - 6500	77	560	82	1.7	9	3480
EALAE12T03	29	2835 SMD	PCB	2600	2700 - 6500	77	1110	82	2.2	9	1830
EALAE12T04	36	2835 SMD	PCB	3155	2700 - 6500	77	1110	82	2.2	9	1830
EALAE12T05	45	2835 SMD	PCB	3565	2700 - 6500	77	1110	82	2.2	9	1830
EALAE22T04	74	2835 SMD	PCB	6305	2700 - 6500	77	1110	82	2.9	9	1830
EALAE13T03	42	2835 SMD	PCB	3900	2700 - 6500	77	1660	82	3.2	9	1160
EALAE13T04	54	2835 SMD	PCB	4735	2700 - 6500	77	1660	82	3.2	9	1160
EALAE13T05	66	2835 SMD	PCB	5345	2700 - 6500	77	1660	82	3.2	9	1160
EALAE23T03	88	2835 SMD	PCB	7800	2700 - 6500	77	1660	82	3.6	9	1160
EALAE23T04	112	2835 SMD	PCB	9460	2700 - 6500	77	1660	82	3.6	9	1160

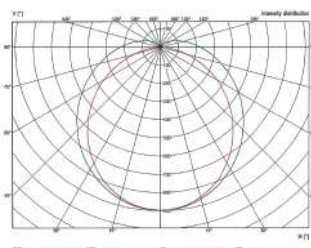
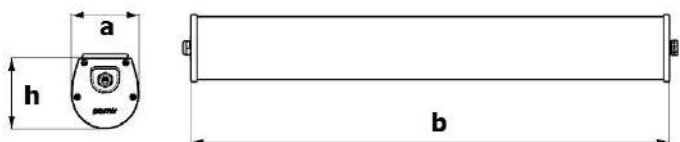

V / Hz 220 - 240 / 50 - 60

Options	Options
Dimmable electronic ballast or convertor.	Ballast électronique dimmable ou converteur.
Emergency kit for models with LED	Kit d'urgence pour les modèles LED.
NOTE	NOTE
Given lumen values are net delivered luminaire output lumens.	Les valeurs de lumens données sont les lumens de sortie nets du luminaire.
Given power values are total consumed AC power of the luminaire.	Les valeurs de puissance données sont la puissance AC totale consommée du luminaire.



# FLUENT

## LED

### Surface Mounted Lighting Fixtures With Diffuser

### Luminaires Apparents Avec Diffuseur

#### APPLICATION AREAS

Factories  
Industrial Kitchens  
Laundries  
Parking Areas  
Outdoor Areas  
Tunnels

#### DOMAINES D'UTILISATION

Usines  
Cuisines Industrielles  
Blanchisseries  
Parkings  
Espaces Exterieurs  
Tunnels

#### BODY

PC extrusion and corrosion resistant body.

#### DIFFUSER

UV stabilized extruded PC diffuser.

#### CEILING FIXING BRACE

Galvanised steel sheet metal with 0.5 mm thickness.

#### CONVERTER

Long life, low power loss converter with constant current. Compatible with ENEC standards.

#### LED

LED modules with 60.000 hours lifetime LUMILEDS / SAMSUNG / NICHIA / SEOUL.

#### CORPS

Extrusion en PC et corps résistant à la corrosion.

#### DIFFUSEUR

Diffuseur en PC extrudé stabilisé aux UV.

#### ACCOLADE DE FIXATION AU PLAFOND

Tôle d'acier galvanisé de 0,5 mm d'épaisseur.

#### CONVERTEUR

Convertisseur, conforme aux normes ENEC. Longue vie. Perte de puissance faible avec courant constant.

#### LED

Modules LED – Durée de vie 60.000 heures avec LED de marque LUMILEDS / SAMSUNG / NICHIA / SEOUL.



## LED Type / Type LED

Color Rendering Index / Indice de Rendu des Couleurs: (CRI): Ra>80

Code	Power Puissance (W)	LED Type Type De LED	LED Module Module LED	Lum. Flux Flux Lum. (lm)	Color Temperature Température De Couleur (K)	Dimensions (mm)			Weight Poids (kg)	Packing Quantity Colisage	Pcs./20" Container Pcs./20" Conteneur
						a	l	h			
EALPE12L15C	14	2835 SMD	PCB	1540	2700 - 6500	58	575	53	0.7	9	10330
EALPE12L25C	21	2835 SMD	PCB	2315	2700 - 6500	58	575	53	0.8	9	10330
EALPE13L15C	21	2835 SMD	PCB	2310	2700 - 6500	58	853	53	1.1	9	6615
EALPE13L25C	30	2835 SMD	PCB	3475	2700 - 6500	58	853	53	1.2	9	6615
EALPE14L15C	26	2835 SMD	PCB	3080	2700 - 6500	58	1133	53	1.5	9	5165
EALPE14L25C	41	2835 SMD	PCB	4630	2700 - 6500	58	1133	53	1.6	9	5165
EALPE15L15C	33	2835 SMD	PCB	3850	2700 - 6500	58	1414	53	1.9	9	4140
EALPE15L25C	51	2835 SMD	PCB	5790	2700 - 6500	58	1414	53	2.0	9	4140
EALPE16L15C	39	2835 SMD	PCB	4620	2700 - 6500	58	1695	53	2.3	9	3420
EALPE16L25C	61	2835 SMD	PCB	6950	2700 - 6500	58	1695	53	2.4	9	3420
EALPE17L15C	47	2835 SMD	PCB	5385	2700 - 6500	58	1976	53	2.7	9	3420
EALPE17L25C	70	2835 SMD	PCB	8110	2700 - 6500	58	1976	53	2.8	9	3420
EALPE18L15C	53	2835 SMD	PCB	6155	2700 - 6500	58	2256	53	3.1	9	2790
EALPE19L15C	60	2835 SMD	PCB	6925	2700 - 6500	58	2536	53	3.5	9	2610
EALPE10L15C	66	2835 SMD	PCB	7695	2700 - 6500	58	2816	53	3.9	9	2250



V / Hz 220 - 240 / 50 - 60

Options	Options
 <p><b>Suspension:</b> Composed of 1mm steel wire rope and nickel-plated brass components. Suspension height is adjustable. Supplied with transparent electric cord and ceiling mounted electrical junction box with aesthetic design.</p>	<p><b>Fixation:</b> Comprend un cable en acier de 1 mm et des composants en laiton nickelé. Livré avec un cordon électrique transparent, une boîte de jonction électrique au design esthétique, à fixer au plafond.</p>

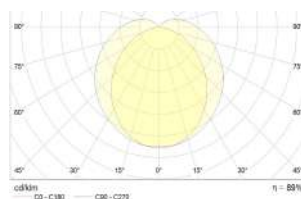

Options	Options
<p>Dimmable electronic ballast or convertor.</p> <p>Emergency kit for models with LED</p>	<p>Ballast électronique dimmable ou converteur.</p> <p>Kit d'urgence pour les modèles LED.</p>
NOTE	NOTE
<p>Given lumen values are net delivered luminaire output lumens.</p> <p>Given power values are total consumed AC power of the luminaire.</p>	<p>Les valeurs de lumens données sont les lumens de sortie nets du luminaire.</p> <p>Les valeurs de puissance données sont la puissance AC totale consommée du luminaire.</p>



## WATERPROOF ETANCHE

### LED

#### 1X Waterproof Lighting Fixtures

#### Luminaire Etanches 1X

#### APPLICATION AREAS

Factories  
Industrial Kitchens  
Laundries  
Parking Areas  
Outdoor Areas  
Tunnels

#### DOMAINES D'UTILISATION

Usines  
Cuisines Industrielles  
Blanchisseries  
Parkings  
Espaces Extérieurs  
Tunnels

#### BODY

Polycarbonate or ABS body of gray color with polycarbonate diffuser holder.

#### DIFFUSER

Polycarbonate diffuser with high light transparency.

#### CEILING FIXING BRACE

Stainless steel sheet metal with 0.5 mm thickness.

#### REFLECTOR

White electrostatic powder coated, sheet metal with 0.5 mm thickness.

#### CONVERTER

Long life, low power loss converter with constant current. Compatible with ENEC standards.

#### LED

LED modules with 60.000 hours lifetime LUMILEDS / SAMSUNG / NICHIA / SEOUL brand LEDs.

#### CORPS

Corps gris en Polycarbonate ou ABS avec por-teur du diffuseur en polycarbonate.

#### DIFFUSEUR

En polycarbonate. Permet une tres grande diffusion de la lumière.

#### ACCOLADE DE FIXATION AU PLAFOND

Feuille d'acier inoxydable de 0.5 mm d'épaisseur.

#### REFLECTEUR

Feuille métallique de 0.5 mm d'épaisseur et peinte en blanc électrostatiquement.

#### CONVERTEUR

Convertisseur, conforme aux normes ENEC. Longue vie. Perte de puissance faible avec cou-rant constant .

#### LED

Modules LED – Durée de vie 60.000 heures avec LED de marque LUMILEDS / SAMSUNG / NICHIA / SEOUL.



LED Type / Type LED

Color Rendering Index / Indice de Rendu des Couleurs: (CRI): Ra>80

Code	Power Puissance (W)	LED Type Type De LED	LED Module Module LED	Lum. Flux Flux Lum. (lm)	Color Temperature Température De Couleur (K)	Dimensions (mm)			Weight Poids (kg)	Packing Quantity Colisage	Pcs./20" Container Pcs./20" Conteneur
						a	b	h			
EAL12L15C	14	2835 SMD	PCB	1635	2700 - 6500	670	95	102	1.2	9	4230
EAL14L15C	26	2835 SMD	PCB	3270	2700 - 6500	1280	95	102	2.2	6	2250
EAL15C02C	25	2835 SMD	PCB	2905	2700 - 6500	1280	95	102	2.2	6	2250
EAL15C03C	35	2835 SMD	PCB	3870	2700 - 6500	1280	95	102	2.2	6	2250
EAL15C04C	47	2835 SMD	PCB	4840	2700 - 6500	1280	95	102	2.2	6	2250

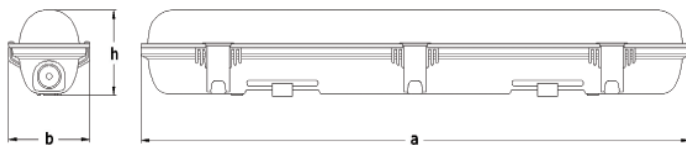

V / Hz 220 - 240 / 50 - 60

Options	Options
Dimmable electronic ballast or convertor. Emergency kit for models with LED	Ballast électronique dimmable ou converteur. Kit d'urgence pour les modèles LED.
NOTE	NOTE
Given lumen values are net delivered luminaire output lumens.	Les valeurs de lumens données sont les lumens de sortie nets du luminaire.
Given power values are total consumed AC power of the luminaire.	Les valeurs de puissance données sont la puissance AC totale consommée du luminaire.

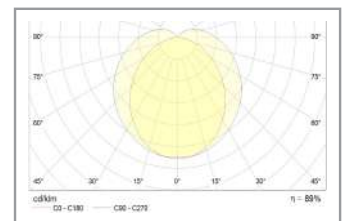
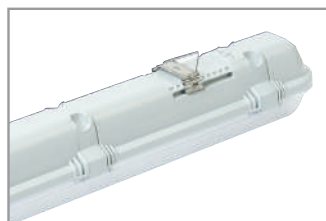
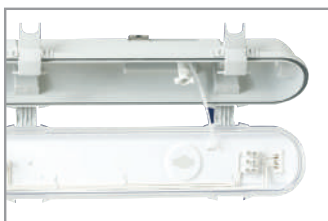





# WATERPROOF ETANCHE

## LED

### 2X Waterproof Lighting Fixtures

### Luminaire Etanches 2X

#### APPLICATION AREAS

Factories  
Industrial Kitchens  
Laundries  
Parking Areas  
Outdoor Areas  
Tunnels

#### DOMAINES D'UTILISATION

Usines  
Cuisines Industrielles  
Blanchisseries  
Parkings  
Espaces Exterieurs  
Tunnels

#### BODY

Polycarbonate or ABS body of gray color with polycarbonate diffuser holder.

#### DIFFUSER

Polycarbonate diffuser with high light transparency.

#### CEILING FIXING BRACE

Stainless steel sheet metal with 0.5 mm thickness.

#### REFLECTOR

White electrostatic powder coated, sheet metal with 0.5 mm thickness.

#### CONVERTER

Long life, low power loss converter with constant current. Compatible with ENEC standards.

#### LED

LED modules with 60.000 hours lifetime LUMILEDS / SAMSUNG / NICHIA / SEOUL brand LEDs.

#### CORPS

Corps gris en Polycarbonate ou ABS avec por-teur du diffuseur en polycarbonate.

#### DIFFUSEUR

En polycarbonate. Permet une tres grande diffusion de la lumière.

#### ACCOLADE DE FIXATION AU PLAFOND

Feuille d'acier inoxydable de 0.5 mm d'epaisseur.

#### REFLECTEUR

Feuille métallique de 0.5 mm d'épaisseur et peinte en blanc électrostatiquement.

#### CONVERTEUR

Convertisseur, conforme aux normes ENEC. Longue vie. Perte de puissance faible avec cou-rant constant .

#### LED

Modules LED – Durée de vie 60.000 heures avec LED de marque LUMILEDS / SAMSUNG / NICHIA / SEOUL.



## LED Type / Type LED

Color Rendering Index / Indice de Rendu des Couleurs: (CRI): Ra>80

Code	Power Puissance (W)	LED Type Type De LED	LED Module Module LED	Lum. Flux Flux Lum. (lm)	Color Temperature Température De Couleur (K)	Dimensions (mm)			Weight Poids (kg)	Packing Quantity Colisage	Pcs./20" Container Pcs./20" Conteneur
						a	b	h			
EAL22L15C	26	2835 SMD	PCB	3270	2700 - 6500	670	140	102	1.2	9	3015
EAL24L15C	53	2835 SMD	PCB	6540	2700 - 6500	1280	140	102	2.2	6	1560
EAL215C02C	50	2835 SMD	PCB	5810	2700 - 6500	1280	140	102	2.2	6	1560
EAL215C03C	70	2835 SMD	PCB	7740	2700 - 6500	1280	140	102	2.2	6	1560

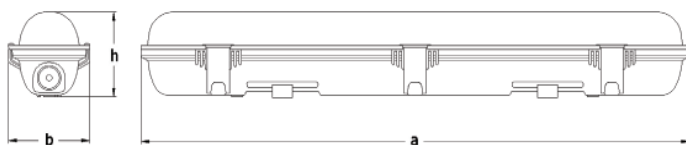

V / Hz 220 - 240 / 50 - 60

Options	Options
Dimmable electronic ballast or convertor.	Ballast électronique dimmable ou converteur.
Emergency kit for models with LED	Kit d'urgence pour les modèles LED.

NOTE	NOTE
Given lumen values are net delivered luminaire output lumens.	Les valeurs de lumens données sont les lumens de sortie nets du luminaire.
Given power values are total consumed AC power of the luminaire.	Les valeurs de puissance données sont la puissance AC totale consommée du luminaire.

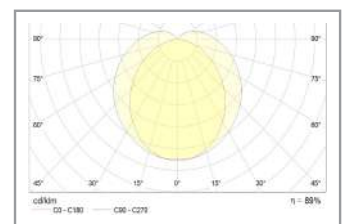
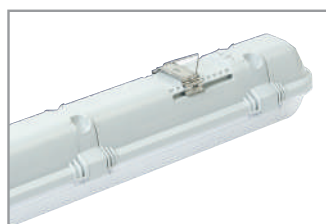
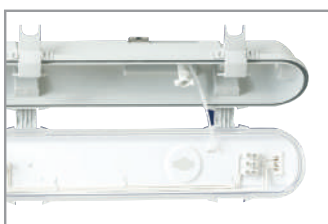



# EXPROOF

## WATERPROOF ETANCHE

### Ex-Proof LED

Ex-Proof Waterproof  
Lighting Fixtures

Luminaire Etanches Ex-Proof

#### APPLICATION AREAS

Factories  
Refinery  
Boiler Room  
Fuel Stations  
Fuel Filling Plants  
Chemical Production

#### DOMAINES D'UTILISATION

Des usines  
Raffinerie  
Chaufferie  
Stations d'essence  
Usines de remplissage de carburant  
Production chimique

#### BODY

Polycarbonate or ABS body of gray color with stainless steel diffuser holder.

#### DIFFUSER

Polycarbonate diffuser with high light transparency.

#### CEILING FIXING BRACE

Stainless steel sheet metal with 0.5 mm thickness.

#### REFLECTOR

White electrostatic powder coated, sheet metal with 0.5 mm thickness.

#### CONVERTER

Long life, low power loss converter with constant current. Compatible with ENEC standards.

#### CABLE GLAND

Polyamide cable gland with ATEX certification.

#### LED

LED modules with 60.000 hours lifetime LUMILEDS / SAMSUNG / NICHIA / SEOUL brand LEDs.

#### CORPS

Corps en polycarbonate ou ABS de couleur grise avec support de diffuseur en acier inoxydable.

#### DIFFUSEUR

En polycarbonate. Permet une tres grande diffusion de la lumière.

#### ACCOLADE DE FIXATION AU PLAFOND

Feuille d'acier inoxydable de 0.5 mm d'épaisseur.

#### REFLECTEUR

Feuille métallique de 0.5 mm d'épaisseur et peinte en blanc électrostatiquement.

#### CONVERTEUR

Convertisseur, conforme aux normes ENEC. Longue vie. Perte de puissance faible avec courant constant .

#### CABLE GLAND

Presse-étoupe en polyamide avec certification ATEX.

#### LED

Modules LED – Durée de vie 60.000 heures avec LED de marque LUMILEDS / SAMSUNG / NICHIA / SEOUL.



LED Type / Type LED

Color Rendering Index / Indice de Rendu des Couleurs: (CRI): Ra>80

Code	Power Puissance (W)	LED Type Type De LED	LED Module Module LED	Lum. Flux Flux Lum. (lm)	Color Temperature Température De Couleur (K)	Dimensions (mm)			Weight Poids (kg)	Packing Quantity Colisage	Pcs./20" Container Pcs./20" Conteneur
						a	b	h			
EAXL22L15C	26	2835 SMD	PCB	3000	2700 - 6500	670	140	102	1.2	9	4230
EAXL22L25C	41	2835 SMD	PCB	4500	2700 - 6500	670	140	102	1.3	9	4230
EAXL14L15C	26	2835 SMD	PCB	3000	2700 - 6500	1280	95	102	1.4	6	2250
EAXL14L25C	41	2835 SMD	PCB	4500	2700 - 6500	1280	95	102	1.5	6	2250
EAXL24L15C	53	2835 SMD	PCB	6000	2700 - 6500	1280	140	102	2.2	6	1560
EAXL24L25C	80	2835 SMD	PCB	9000	2700 - 6500	1280	140	102	2.2	6	1560

V / Hz 220 - 240 / 50 - 60

Options	Options
Dimmable electronic ballast or convertor. Emergency kit for models with LED	Ballast électronique dimmable ou converteur. Kit d'urgence pour les modèles LED.
NOTE	NOTE
Given lumen values are net delivered luminaire output lumens. Given power values are total consumed AC power of the luminaire.	Les valeurs de lumens données sont les lumens de sortie nets du luminaire. Les valeurs de puissance données sont la puissance AC totale consommée du luminaire.

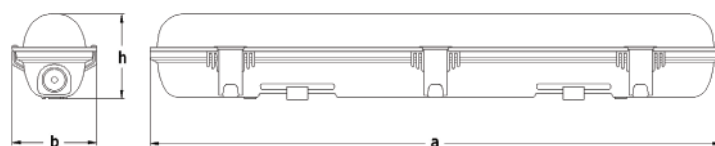



# EXPROOF

## WATERPROOF ETANCHE

### Ex-Proof T8

2x Ex-Proof Waterproof Lighting  
Fixtures

Luminaires Etanches Ex-Proof 2x

#### APPLICATION AREAS

Factories  
Refinery  
Boiler Room  
Fuel Stations  
Fuel Filling Plants  
Chemical Production

#### DOMAINES D'UTILISATION

Des usines  
Raffinerie  
Chaufferie  
Stations d'essence  
Usines de remplissage de carburant  
Production chimique

#### BODY

Polycarbonate or ABS body of gray color with polycarbonate diffuser holder.

#### DIFFUSER

Polycarbonate diffuser with high light transparency.

#### CEILING FIXING BRACE

Stainless steel sheet metal with 0.5 mm thickness.

#### REFLECTOR

White electrostatic powder coated, sheet metal with 0.5 mm thickness.

#### BALLAST

Electronic ballast with EN norms.

#### SECURITY

Energy cut-off system when the cover(diffuser) is opened.

#### CABLE GLAND

Polyamide cable gland with ATEX certification.

#### CORPS

Corps gris en Polycarbonate ou ABS avec porteur du diffuseur en polycarbonate.

#### DIFFUSEUR

En polycarbonate. Permet une tres grande diffusion de la lumière.

#### ACCOLADE DE FIXATION AU PLAFOND

Feuille d'acier inoxydable de 0.5 mm d'epaisseur.

#### REFLECTEUR

Feuille métallique de 0.5 mm d'épaisseur et peinte en blanc électrostatiquement.

#### BALLAST

Ballast électronique compatible avec les standards ENEC.

#### SÉCURITÉ

Système de coupure d'énergie lorsque le couvercle (diffuseur) est ouvert.

#### CABLE GLAND

Presse-étoupe en polyamide avec certification ATEX.



### T5 & T8 Fluorescent Type / Type T5 & T8 Fluorescent

Code	Power Puissance (W)	Lamp Type Type De Lampe	Socket Type Type De Douille	Lum. Flux Flux Lum. (lm)	Current Courant (A)	Dimensions (mm)			Weight Poids (kg)	Packing Quantity Colisage	Pcs./20" Pcs./20" Conteneur	Container Conteneur	ZONE
						a	b	h					
EAX218	2x18	T26 (T8)	G13	2700	0.37	670	140	102	1.59	9	3015	ZONE 2	
EAX236	2x36	T26 (T8)	G13	6500	0.43	1280	140	102	2.18	9	1560		
EAX254	2x54	T16(T5)	G5	8900	0.50	1280	140	102	2.18	9	1560		



V / Hz | 220 - 240 / 50 - 60

Options	Options
Dimmable electronic ballast or convertor.	Ballast électronique dimmable ou converteur.
Emergency kit for models with LED	Kit d'urgence pour les modèles LED.

NOTE	NOTE
Given lumen values are net delivered luminaire output lumens.	Les valeurs de lumens données sont les lumens de sortie nets du luminaire.
Given power values are total consumed AC power of the luminaire.	Les valeurs de puissance données sont la puissance AC totale consommée du luminaire.

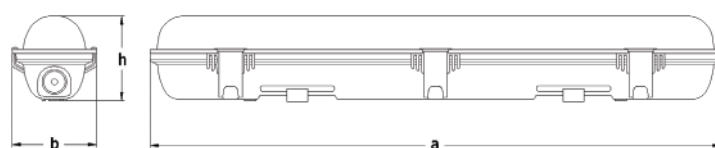



# WATERPROOF ETANCHE

## T16 (T5)

1X Waterproof Lighting Fixtures

Luminaire Etanches 1X

### APPLICATION AREAS

Factories  
Industrial Kitchens  
Laundries  
Parking Areas  
Outdoor Areas  
Tunnels

### DOMAINES D'UTILISATION

Usines  
Cuisines Industrielles  
Blanchisseries  
Parkings  
Espaces Exterieurs  
Tunnels

#### BODY

Polycarbonate or ABS body of gray color with polycarbonate diffuser holder.

#### DIFFUSER

Polycarbonate diffuser with high light transparency.

#### CEILING FIXING BRACE

Stainless steel sheet metal with 0.5 mm thickness.

#### REFLECTOR

White electrostatic powder coated, sheet metal with 0.5 mm thickness.

#### BALLAST

Electronic ballast with long life, low power loss EEI = A2 and constant flux. Compatible with ENEC standards.

#### CORPS

Corps gris en Polycarbonate ou ABS avec por-teur du diffuseur en polycarbonate.

#### DIFFUSEUR

En polycarbonate. Permet une tres grande diffusion de la lumiere.

#### ACCOLADE DE FIXATION AU PLAFOND

Feuille d'acier inoxydable de 0.5 mm d'epaisseur.

#### REFLECTEUR

Feuille metallique de 0.5 mm d'epaisseur et peinte en blanc electrostatiquement.

#### BALLAST

Ballast electronique , conforme aux normes ENEC. Longue vie. Perte de puissance faible (EEI = A2). Flux de lumiere regulier.



## T5 Fluorescent Type / Type T5 Fluorescent

Code	Power Puissance (W)	Lamp Type Type De Lampe	Socket Type Type De Douille	Lum. Flux Flux Lum. (lm)	Current Courant (A)	Dimensions (mm)			Weight Poids (kg)	Packing Quantity Colisage	Pcs./20" Container Pcs./20" Conteneur
						a	b	h			
EAEB128	1x28	T16(T5)	G5	2600	0.14	1280	95	102	1.70	9	2250
EAEB154	1x54	T16(T5)	G5	4450	0.26	1280	95	102	1.70	9	2250
EAEB135	1x35	T16(T5)	G5	3300	0.17	1570	95	102	2.05	6	1710
EAEB149	1x49	T16(T5)	G5	4300	0.24	1570	95	102	2.05	6	1710
EAEB180	1x80	T16(T5)	G5	6150	0.38	1570	95	102	2.05	6	1710

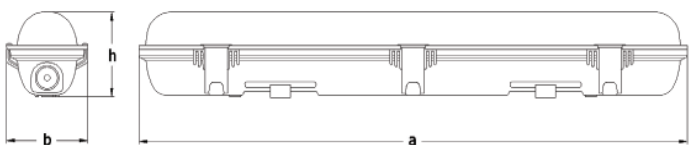

V / Hz 220 - 240 / 50 - 60

Options	Options
Dimmable electronic ballast or convertor. Emergency kit for models with LED	Ballast électronique dimmable ou converteur. Kit d'urgence pour les modèles LED.
NOTE	NOTE
Given lumen values are net delivered luminaire output lumens.	Les valeurs de lumens données sont les lumens de sortie nets du luminaire.
Given power values are total consumed AC power of the luminaire.	Les valeurs de puissance données sont la puissance AC totale consommée du luminaire.

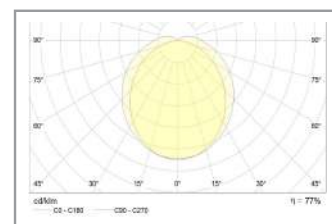
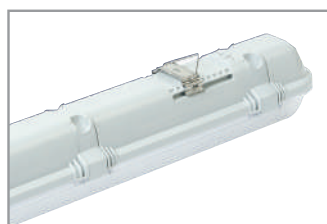
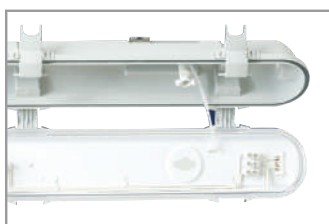





## WATERPROOF ETANCHE

### T16 (T5)

#### 2X Waterproof Lighting Fixtures

#### Luminaire Etanches 2X

##### APPLICATION AREAS

Factories  
Industrial Kitchens  
Laundries  
Parking Areas  
Outdoor Areas  
Tunnels

##### DOMAINES D'UTILISATION

Usines  
Cuisines Industrielles  
Blanchisseries  
Parkings  
Espaces Exterieurs  
Tunnels

##### BODY

Polycarbonate or ABS body of gray color with polycarbonate diffuser holder.

##### DIFFUSER

Polycarbonate diffuser with high light transparency.

##### CEILING FIXING BRACE

Stainless steel sheet metal with 0.5 mm thickness.

##### REFLECTOR

White electrostatic powder coated, sheet metal with 0.5 mm thickness.

##### BALLAST

Electronic ballast with long life, low power loss EEI = A2 and constant flux. Compatible with ENEC standards.

##### CORPS

Corps gris en Polycarbonate ou ABS avec por-teur du diffuseur en polycarbonate.

##### DIFFUSEUR

En polycarbonate. Permet une tres grande diffusion de la lumière.

##### ACCOLADE DE FIXATION AU PLAFOND

Feuille d'acier inoxydable de 0.5 mm d'épaisseur.

##### REFLECTEUR

Feuille métallique de 0.5 mm d'épaisseur et peinte en blanc électrostatiquement.

##### BALLAST

Ballast électronique, conforme aux normes ENEC. Longue vie. Perte de puissance faible (EEI = A2). Flux de lumière régulier.



## T5 Fluorescent Type / Type T5 Fluorescent

Code	Power Puissance (W)	Lamp Type Type De Lampe	Socket Type Type De Douille	Lum. Flux Flux Lum. (lm)	Current Courant (A)	Dimensions (mm)			Weight Poids (kg)	Packing Quantity Colisage	Pcs./20" Container Pcs./20" Conteneur
						a	b	h			
EAEB228	2x28	T16(T5)	G5	5200	0.26	1280	140	102	2.18	6	1560
EAEB254	2x54	T16(T5)	G5	8900	0.50	1280	140	102	2.18	6	1560
EAEB235	2x35	T16(T5)	G5	6600	0.33	1570	140	102	2.65	6	1350
EAEB249	2x49	T16(T5)	G5	8600	0.49	1570	140	102	2.65	6	1350
EAEB280	2x80	T16(T5)	G5	12300	0.76	1570	140	102	2.65	6	1350

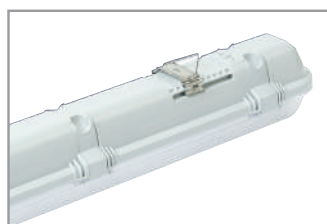
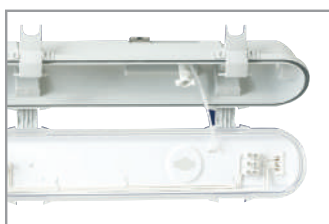
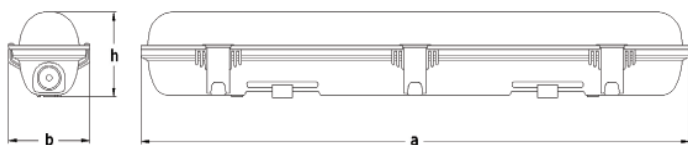

V / Hz 220 - 240 / 50 - 60

Options	Options
Dimmable electronic ballast or convertor. Emergency kit for models with LED	Ballast électronique dimmable ou convertor. Kit d'urgence pour les modèles LED.

NOTE	NOTE
Given lumen values are net delivered luminaire output lumens.	Les valeurs de lumens données sont les lumens de sortie nets du luminaire.
Given power values are total consumed AC power of the luminaire.	Les valeurs de puissance données sont la puissance AC totale consommée du luminaire.

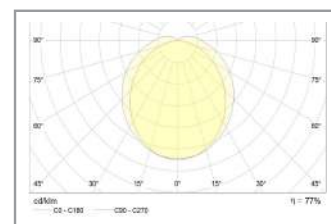



## WATERPROOF ETANCHE

### T26 (T8)

1X Waterproof Lighting Fixtures

Luminaire Etanches 1X

#### APPLICATION AREAS

Factories  
Industrial Kitchens  
Laundries  
Parking Areas  
Outdoor Areas  
Tunnels

#### DOMAINES D'UTILISATION

Usines  
Cuisines Industrielles  
Blanchisseries  
Parkings  
Espaces Exterieurs  
Tunnels

#### BODY

Polycarbonate or ABS body of gray color with polycarbonate diffuser holder.

#### DIFFUSER

Polycarbonate diffuser with high light transparency.

#### CEILING FIXING BRACE

Stainless steel sheet metal with 0.5 mm thickness.

#### REFLECTOR

White electrostatic powder coated, sheet metal with 0.5 mm thickness.

#### BALLAST

Electronic ballast with long life, low power loss EEI = A2 and constant flux. Compatible with ENEC standards.

#### CORPS

Corps gris en Polycarbonate ou ABS avec por-teur du diffuseur en polycarbonate.

#### DIFFUSEUR

En polycarbonate. Permet une tres grande diffusion de la lumiere.

#### ACCOLADE DE FIXATION AU PLAFOND

Feuille d'acier inoxydable de 0.5 mm d'epaisseur.

#### REFLECTEUR

Feuille metallique de 0.5 mm d'epaisseur et peinte en blanc electrostatiquement.

#### BALLAST

Ballast electronique , conforme aux normes ENEC. Longue vie. Perte de puissance faible (EEI = A2). Flux de lumiere regulier.



## T8 Fluorescent Type / Type T8 Fluorescent

Code	Power Puissance (W)	Lamp Type Type De Lampe	Socket Type Type De Douille	Lum. Flux Flux Lum. (lm)	Current Courant (A)	Dimensions (mm) a b h	Weight Poids (kg)	Packing Quantity Colisage	Pcs./20" Container Pcs./20" Conteneur	Ballast Type Type de Balast
EAMB118	1x18	T26 (T8)	G13	1350	0.37	670 95 102	1.30	9	4230	Magnetic Magnétique
EAMB136	1x36	T26 (T8)	G13	3250	0.43	1280 95 102	1.99	9	2250	
EAEB118	1x18	T26 (T8)	G13	1350	0.08	670 95 102	0.99	9	4230	Electronic Electronique
EAEB136	1x36	T26 (T8)	G13	3250	0.17	1280 95 102	1.70	9	2250	
EAEB158	1x58	T26 (T8)	G13	5200	0.24	1570 95 102	2.05	6	1710	

## With Led Tube Wiring / Avec Cablage Led Tube

Code	Lamp Type Type De Lampe	Socket Type Type De Douille	Dimensions (mm) a b h	Weight Poids (kg)	Packing Quantity Colisage	Pcs./20" Container Pcs./20" Conteneur
EA118LT	T26(T8)	G13	670 95 102	0,85	9	4230
EA136LT	T26(T8)	G13	1280 95 102	1,55	9	2250
EA158LT	T26(T8)	G13	1570 95 102	1,95	6	1710

V / Hz 220 - 240 / 50 - 60

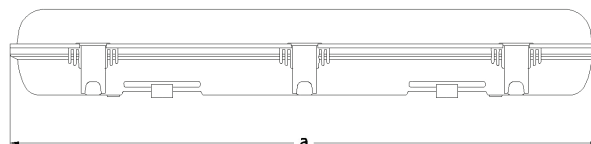
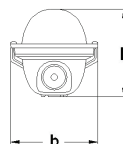
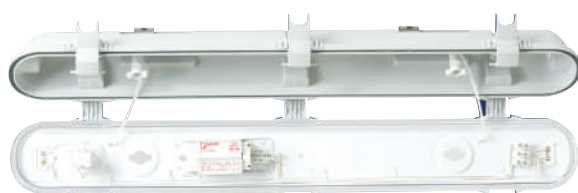

Options	Options
Dimmable electronic ballast or convertor.	Ballast électronique dimmable ou converteur.
Emergency kit for models with LED	Kit d'urgence pour les modèles LED.
NOTE	NOTE
Given lumen values are net delivered luminaire output lumens.	Les valeurs de lumens données sont les lumens de sortie nets du luminaire.
Given power values are total consumed AC power of the luminaire.	Les valeurs de puissance données sont la puissance AC totale consommée du luminaire.



# ETANJ WATERPROOF ETANCHE

## T26 (T8)

### 2X Waterproof Lighting Fixtures

### Luminaire Etanches 2X

#### APPLICATION AREAS

Factories  
Industrial Kitchens  
Laundries  
Parking Areas  
Outdoor Areas  
Tunnels

#### DOMAINES D'UTILISATION

Usines  
Cuisines Industrielles  
Blanchisseries  
Parkings  
Espaces Exterieurs  
Tunnels

#### BODY

Polycarbonate or ABS body of gray color with polycarbonate diffuser holder.

#### DIFFUSER

Polycarbonate diffuser with high light transparency.

#### CEILING FIXING BRACE

Stainless steel sheet metal with 0.5 mm thickness.

#### REFLECTOR

White electrostatic powder coated, sheet metal with 0.5 mm thickness.

#### BALLAST

Electronic ballast with long life, low power loss EEI = A2 and constant flux. Compatible with ENEC standards.

#### CORPS

Corps gris en Polycarbonate ou ABS avec por-teur du diffuseur en polycarbonate.

#### DIFFUSEUR

En polycarbonate. Permet une tres grande diffusion de la lumiere.

#### ACCOLADE DE FIXATION AU PLAFOND

Feuille d'acier inoxydable de 0.5 mm d'epaisseur.

#### REFLECTEUR

Feuille metallique de 0.5 mm d'epaisseur et peinte en blanc electrostatiquement.

#### BALLAST

Ballast electronique , conforme aux normes ENEC. Longue vie. Perte de puissance faible (EEI = A2). Flux de lumiere regulier.



## T8 Fluorescent Type / Type T8 Fluorescent

Code	Power Puissance (W)	Lamp Type Type De Lampe	Socket Type Type De Douille	Lum. Flux Flux Lum. (lm)	Current Courant (A)	Dimensions (mm) a b h	Weight Poids (kg)	Packing Quantity Colisage	Pcs./20" Container Pcs./20" Conteneur	Ballast Type Type de Balast
EAMB218	2x18	T26 (T8)	G13	2700	0.37	670 140 102	1.59	6	1962	Magnetic Magnétique
EAMB236	2x36	T26 (T8)	G13	6500	0.86	1280 140 102	2.96	6	1560	
EAEB218	2x18	T26 (T8)	G13	2700	0.18	670 140 102	1.30	6	1962	Electronic Electronique
EAEB236	2x36	T26 (T8)	G13	6500	0.32	1280 140 102	2.18	6	1560	
EAEB258	2x58	T26 (T8)	G13	10400	0.48	1570 140 102	2.64	6	1290	

## With Led Tube Wiring / Avec Cablage Led Tube

Code	Lamp Type Type De Lampe	Socket Type Type De Douille	Dimensions (mm) a b h	Weight Poids (kg)	Packing Quantity Colisage	Pcs./20" Container Pcs./20" Conteneur
EA218LT	T26(T8)	G13	670 140 102	1,15	9	3015
EA236LT	T26(T8)	G13	1280 140 102	2,10	6	1560
EA258LT	T26(T8)	G13	1570 140 102	2,50	6	1000

V / Hz 220 - 240 / 50 - 60

Options	Options
Dimmable electronic ballast or convertor. Emergency kit for models with LED	Ballast électronique dimmable ou converteur. Kit d'urgence pour les modèles LED.
NOTE	NOTE
Given lumen values are net delivered luminaire output lumens.	Les valeurs de lumens données sont les lumens de sortie nets du luminaire.
Given power values are total consumed AC power of the luminaire.	Les valeurs de puissance données sont la puissance AC totale consommée du luminaire.

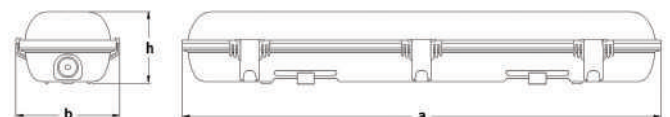
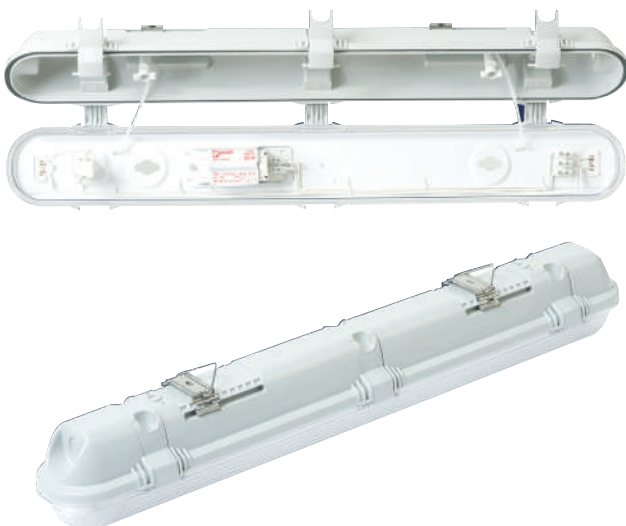





**TRACK LIGHT / ÉCLAIRAGE SUR RAIL**





## RAY SPOT

# LED

## Track Light

## Éclairage Sur Rail

### APPLICATION AREAS

Shopping Malls  
Supermarkets  
Offices  
Meeting rooms  
Stores  
Hospitals  
Schools  
Corridors

### DOMAINES D'UTILISATION

Centres Commerciaux  
Supermarchés  
Bureaux  
Salles de Réunion  
Magasins  
Hopitaux  
Ecoles  
Coulors

#### BODY

Aluminum profile frame and injection head.

#### REFLECTOR

High-purity aluminum reflector; narrow, medium and wide angle options.

#### CONVERTER

Long life, low power loss converter with constant current. Compatible with ENEC standards.

#### LED

LED modules with 60.000 hours lifetime SAMSUNG / OSRAM / PHILIPS brand LEDs.

#### CORPS

Profilé en aluminium et tête d'injection.

#### REFLECTEUR

Réflecteur en aluminium de haute pureté; options d'angle étroit, moyen et large.

#### CONVERTEUR

Convertisseur, conforme aux normes ENEC. Longue vie. Perte de puissance faible avec courant constant.

#### LED

Modules LED – Durée de vie 60.000 heures avec LED de marque SAMSUNG / OSRAM / PHILIPS.



LED Type / Type LED

Color Rendering Index / Indice de Rendu des Couleurs: (CRI): Ra>80

Code	Power Puissance (W)	Led Type Type De Led	Lum. Flux Flux Lum. (lm)	Color Temperature Température De Couleur (K)	Dimensions (mm)			Weight Poids (kg)	Packing Quantity Colisage	Pcs./20" Container Pcs./20" Conteneur
					a	b	h			
PLR1U21C	21	COB	1910	2700 - 6500	118	245	302	1,50	24	12960
PLR1U28C	28	COB	2870	2700 - 6500	118	245	302	1,50	24	12960

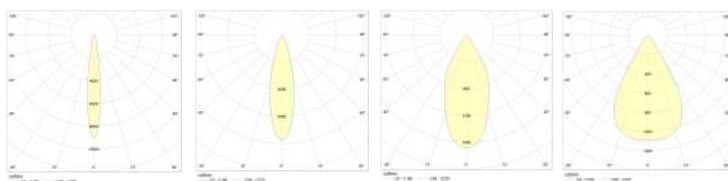
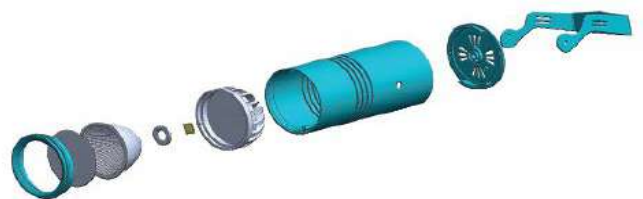
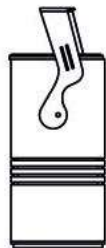
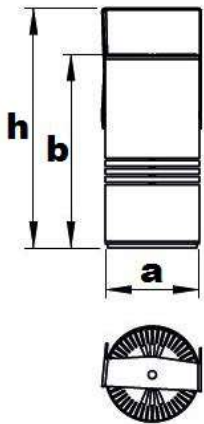

15° Reflector

30° Reflector

45° Reflector

60° Reflector

V / Hz 220 - 240 / 50 - 60

Options	Options
Dimmable electronic ballast or convertor.	Ballast électronique dimmable ou converteur.
Emergency kit for models with LED	Kit d'urgence pour les modèles LED.
NOTE	NOTE
Given lumen values are net delivered luminaire output lumens.	Les valeurs de lumens données sont les lumens de sortie nets du luminaire.
Given power values are total consumed AC power of the luminaire.	Les valeurs de puissance données sont la puissance AC totale consommée du luminaire.



## RAY SPOT

# LED

## Track Light

## Éclairage Sur Rail

### APPLICATION AREAS

Shopping Malls  
Supermarkets  
Offices  
Meeting rooms  
Stores  
Hospitals  
Schools  
Corridors

### DOMAINES D'UTILISATION

Centres Commerciaux  
Supermarchés  
Bureaux  
Salles de Réunion  
Magasins  
Hopitaux  
Ecoles  
Couloirs

#### BODY

Aluminum profile frame and injection head.

#### REFLECTOR

High-purity aluminum reflector; narrow, medium and wide angle options.

#### CONVERTER

Long life, low power loss converter with constant current. Compatible with ENEC standards.

#### LED

LED modules with 60.000 hours lifetime SAMSUNG / OSRAM / PHILIPS brand LEDs.

#### CORPS

Profilé en aluminium et tête d'injection.

#### REFLECTEUR

Réflecteur en aluminium de haute pureté; options d'angle étroit, moyen et large.

#### CONVERTEUR

Convertisseur, conforme aux normes ENEC. Longue vie. Perte de puissance faible avec courant constant.

#### LED

Modules LED – Durée de vie 60.000 heures avec LED de marque SAMSUNG / OSRAM / PHILIPS.



## LED Type / Type LED

Color Rendering Index / Indice de Rendu des Couleurs: (CRI): Ra>80

Code	Power Puissance (W)	Led Type Type De Led	Lum. Flux Flux Lum. (lm)	Color Temperature Température De Couleur (K)	Dimensions (mm)			Weight Poids (kg)	Packing Quantity Colisage	Pcs./20" Container Pcs./20" Conteneur
					a	b	h			
PLR2U21C	21	COB	1910	2700 - 6500	90	150	178	1,50	24	12960
PLR2U28C	28	COB	2870	2700 - 6500	90	150	178	1,50	24	12960
PLR2U36C	36	COB	3420	2700 - 6500	90	150	178	1,50	24	12960
PLR2U42C	42	COB	3660	2700 - 6500	90	150	178	1,50	24	12960

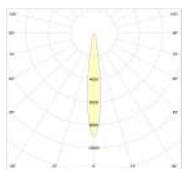
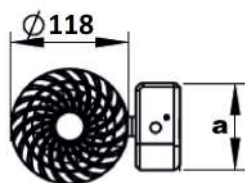
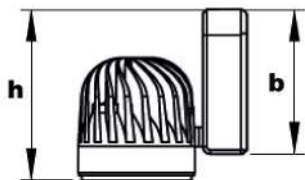

15° Reflector

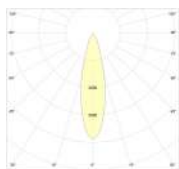

30° Reflector

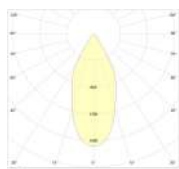

45° Reflector

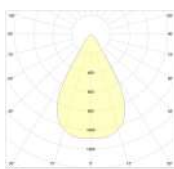

60° Reflector



V / Hz 220 - 240 / 50 - 60

Options	Options
Dimmable electronic ballast or convertor.	Ballast électronique dimmable ou converteur.
Emergency kit for models with LED	Kit d'urgence pour les modèles LED.

NOTE	NOTE
Given lumen values are net delivered luminaire output lumens.	Les valeurs de lumens données sont les lumens de sortie nets du luminaire.
Given power values are total consumed AC power of the luminaire.	Les valeurs de puissance données sont la puissance AC totale consommée du luminaire.



## RAY SPOT

# LED

## Track Light

## Éclairage Sur Rail

### APPLICATION AREAS

Shopping Malls  
Supermarkets  
Offices  
Meeting rooms  
Stores  
Hospitals  
Schools  
Corridors

### DOMAINES D'UTILISATION

Centres Commerciaux  
Supermarchés  
Bureaux  
Salles de Réunion  
Magasins  
Hopitaux  
Ecoles  
Couloirs

#### BODY

Aluminum profile frame and injection head.

#### REFLECTOR

High-purity aluminum reflector; narrow, medium and wide angle options.

#### CONVERTER

Long life, low power loss converter with constant current. Compatible with ENEC standards.

#### LED

LED modules with 60.000 hours lifetime SAMSUNG / OSRAM / PHILIPS brand LEDs.

#### CORPS

Profilé en aluminium et tête d'injection.

#### REFLECTEUR

Réflecteur en aluminium de haute pureté; options d'angle étroit, moyen et large.

#### CONVERTEUR

Convertisseur, conforme aux normes ENEC. Longue vie. Perte de puissance faible avec courant constant.

#### LED

Modules LED – Durée de vie 60.000 heures avec LED de marque SAMSUNG / OSRAM / PHILIPS.



## LED Type / Type LED

Color Rendering Index / Indice de Rendu des Couleurs: (CRI): Ra>80

Code	Power Puissance (W)	Led Type Type De Led	Lum. Flux Flux Lum. (lm)	Color Temperature Température De Couleur (K)	Dimensions (mm)			Weight Poids (kg)	Packing Quantity Colisage	Pcs./20" Container Pcs./20" Conteneur
					a	b	h			
PLR3U21C	21	COB	1910	2700 - 6500	100	220	260	1,25	24	10000
PLR3U28C	28	COB	2870	2700 - 6500	100	220	260	1,25	24	10000

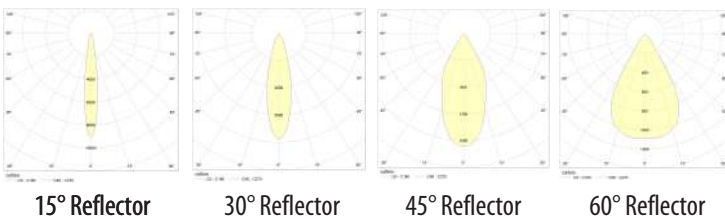
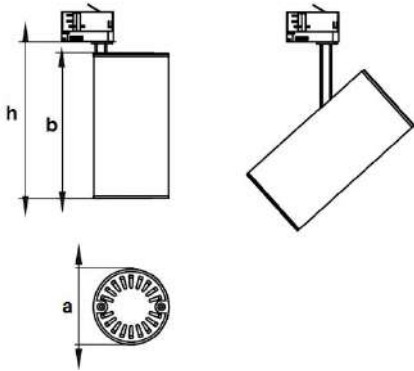

V / Hz      220 - 240 / 50 - 60

Options	Options
Dimmable electronic ballast or convertor.	Ballast électronique dimmable ou converteur.
Emergency kit for models with LED	Kit d'urgence pour les modèles LED.
NOTE	NOTE
Given lumen values are net delivered luminaire output lumens.	Les valeurs de lumens données sont les lumens de sortie nets du luminaire.
Given power values are total consumed AC power of the luminaire.	Les valeurs de puissance données sont la puissance AC totale consommée du luminaire.



## RAY SPOT

# LED

## Track Light

## Éclairage Sur Rail

### APPLICATION AREAS

Shopping Malls  
Supermarkets  
Offices  
Meeting rooms  
Stores  
Hospitals  
Schools  
Corridors

### DOMAINES D'UTILISATION

Centres Commerciaux  
Supermarchés  
Bureaux  
Salles de Réunion  
Magasins  
Hopitaux  
Ecoles  
Couloirs

#### BODY

Aluminum profile frame and injection head.

#### REFLECTOR

High-purity aluminum reflector; narrow, medium and wide angle options.

#### CONVERTER

Long life, low power loss converter with constant current. Compatible with ENEC standards.

#### LED

LED modules with 60.000 hours lifetime SAMSUNG / OSRAM / PHILIPS brand LEDs.

#### CORPS

Profilé en aluminium et tête d'injection.

#### REFLECTEUR

Réflecteur en aluminium de haute pureté; options d'angle étroit, moyen et large.

#### CONVERTEUR

Convertisseur, conforme aux normes ENEC. Longue vie. Perte de puissance faible avec courant constant.

#### LED

Modules LED – Durée de vie 60.000 heures avec LED de marque SAMSUNG / OSRAM / PHILIPS.



LED Type / Type LED

Color Rendering Index / Indice de Rendu des Couleurs: (CRI): Ra>80

Code	Power Puissance (W)	Led Type Type De Led	Lum. Flux Flux Lum. (lm)	Color Temperature Température De Couleur (K)	Dimensions (mm)			Weight Poids (kg)	Packing Quantity Colisage	Pcs./20" Container Pcs./20" Conteneur
					a	b	h			
PLR4U15C	15W	COB	1370	2700 - 6500	85	108	124	1,00	12	12000
PLR4U21C	21W	COB	1774	2700 - 6500	85	108	124	1,00	12	12000

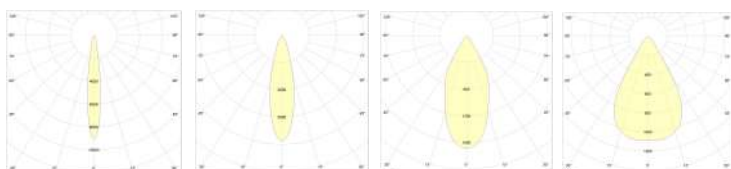
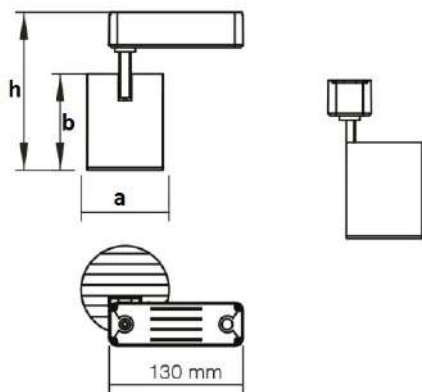

15° Reflector

30° Reflector

45° Reflector

60° Reflector

V / Hz 220 - 240 / 50 - 60

Options	Options
Dimmable electronic ballast or convertor.	Ballast électronique dimmable ou converteur.
Emergency kit for models with LED	Kit d'urgence pour les modèles LED.

NOTE	NOTE
Given lumen values are net delivered luminaire output lumens.	Les valeurs de lumens données sont les lumens de sortie nets du luminaire.
Given power values are total consumed AC power of the luminaire.	Les valeurs de puissance données sont la puissance AC totale consommée du luminaire.







**DOWNLIGHTS**

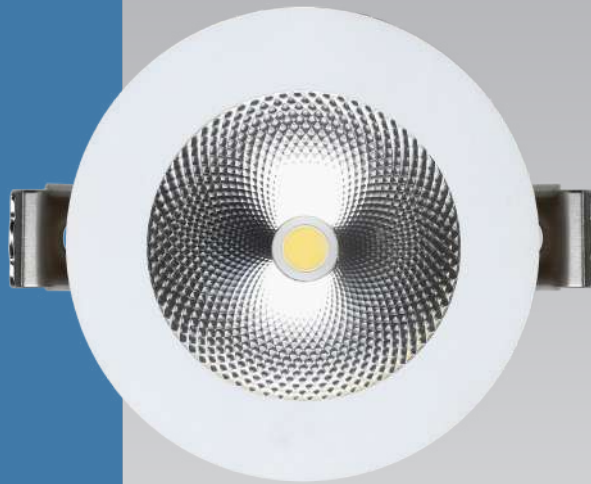

## DOWNLIGHT

### LED

Recessed COB Downlight

COB Encastré Downlight

#### APPLICATION AREAS

Shopping Malls  
Supermarkets  
Offices  
Meeting rooms  
Stores  
Hospitals  
Schools  
Corridors

#### DOMAINES D'UTILISATION

Centres Commerciaux  
Supermarchés  
Bureaux  
Salles de Réunion  
Magasins  
Hopitaux  
Ecoles  
Couloirs

#### BODY

White or optional any type of finishing color aluminum body and effective cooling performance.

#### DIFFUSER

UV stabilized transparent diffuser.

#### CONVERTER

Long life, low power loss converter with constant current. Compatible with ENEC standards.

#### LED

LED modules with 60.000 hours lifetime SAMSUNG / OSRAM / PHILIPS brand LEDs.

#### CORPS

Blanc ou facultatif n'importe quel type de corps en aluminium de couleur de finition et exécution efficace de refroidissement.

#### DIFFUSEUR

Transparent diffuseur en anti UV.

#### CONVERTEUR

Convertisseur, conforme aux normes ENEC. Longue vie. Perte de puissance faible avec courant constant .

#### LED

Modules LED – Durée de vie 60.000 heures avec LED de marque SAMSUNG / OSRAM /PHILIPS.



## LED Type / Type LED

Color Rendering Index / Indice de Rendu des Couleurs: (CRI): Ra>80

Code	Power Puissance (W)	Led Type Type De Led	Lum. Flux Flux Lum. (lm)	Frame Flange Type Type de Bride de Cadre	Ceiling Cut (mm) Coupe de Plafond	Dimensions (mm) d h		Weight Poids (kg)	Packing Quantity Colisage	Pcs./20" Container Pcs./20" Conteneur
PLC1AY10C225	10	COB	1000	2"	85	97	55	0,21	48	28560
PLC1AY10C325	10	COB	1170	3"	105	117	50	0,27	36	21420
PLC1AY15C335	15	COB	1520	3"	105	117	50	0,27	36	21420
PLC1AY10C425	10	COB	1170	4"	130	147	55	0,39	36	14040
PLC1AY14C435	14	COB	1920	4"	130	147	55	0,44	36	14040
PLC1AY21C45	21	COB	2620	4"	130	147	55	0,55	16	14040
PLC1AY14C635	14	COB	2000	6"	175	192	55	0,64	16	7640
PLC1AY21C65	21	COB	2700	6"	175	192	55	0,64	16	7640
PLC1AY29C67	29	COB	3400	6"	175	192	55	0,64	16	7640
PLC1AY14C835	14	COB	2100	8"	210	227	55	0,75	16	6100
PLC1AY21C85	21	COB	2800	8"	210	227	55	0,75	16	6100
PLC1AY29C87	29	COB	3500	8"	210	227	55	0,75	16	6100

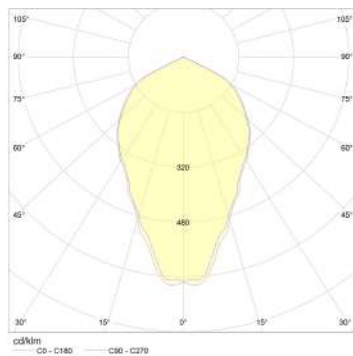
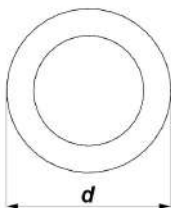
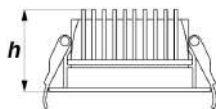

V / Hz 220 - 240 / 50 - 60

Options	Options
Dimmable electronic ballast or convertor.	Ballast électronique dimmable ou converteur.
Emergency kit for models with LED	Kit d'urgence pour les modèles LED.
NOTE	NOTE
Given lumen values are net delivered luminaire output lumens.	Les valeurs de lumens données sont les lumens de sortie nets du luminaire.
Given power values are total consumed AC power of the luminaire.	Les valeurs de puissance données sont la puissance AC totale consommée du luminaire.



## DOWNLIGHT

### LED

Recessed COB Downlight

COB Encastré Downlight

#### APPLICATION AREAS

Shopping Malls  
Supermarkets  
Offices  
Meeting rooms  
Stores  
Hospitals  
Schools  
Corridors

#### DOMAINES D'UTILISATION

Centres Commerciaux  
Supermarchés  
Bureaux  
Salles de Réunion  
Magasins  
Hopitaux  
Ecoles  
Couloirs

#### BODY

White or optional any type of finishing color aluminum body and effective cooling performance.

#### DIFFUSER

UV stabilized transparent diffuser.

#### CONVERTER

Long life, low power loss converter with constant current. Compatible with ENEC standards.

#### LED

LED modules with 60.000 hours lifetime SAMSUNG / OSRAM / PHILIPS brand LEDs.

#### CORPS

Blanc ou facultatif n'importe quel type de corps en aluminium de couleur de finition et exécution efficace de refroidissement.

#### DIFFUSEUR

Transparent diffuseur en anti UV.

#### CONVERTEUR

Convertisseur, conforme aux normes ENEC. Longue vie. Perte de puissance faible avec courant constant .

#### LED

Modules LED – Durée de vie 60.000 heures avec LED de marque SAMSUNG / OSRAM / PHILIPS.



LED Type / Type LED

Color Rendering Index / Indice de Rendu des Couleurs: (CRI): Ra>80

Code	Power Puissance (W)	Led Type Type De Led	Lum. Flux Flux Lum. (lm)	Frame Flange Type Type de Bride de Cadre	Ceiling Cut (mm) Coupe de Plafond	Dimensions (mm) d h	Weight Poids (kg)	Packing Quantity Colisage	Pcs./20" Container Pcs./20" Conteneur
PLC2AY10C125	10	COB	855	1"	70	80 70	0,24	48	25920
PLC2AY10C225	10	COB	950	2"	90	108 70	0,26	36	19440
PLC2AY10C325	10	COB	1110	3"	105	128 55	0,26	36	19440
PLC2AY15C335	15	COB	1400	3"	105	128 55	0,33	36	12780
PLC2AY10C425	10	COB	1075	4"	130	150 55	0,50	16	7840
PLC2AY15C435	15	COB	1445	4"	130	150 55	0,50	16	7840
PLC2AY21C45	21	COB	2410	4"	130	150 55	0,50	16	7840
PLC2AY14C635	14	COB	1825	6"	180	200 55	0,58	16	6840
PLC2AY21C65	21	COB	2490	6"	180	200 55	0,58	16	6840
PLC2AY29C67	29	COB	3130	6"	180	200 55	0,58	16	6840
PLC2AY14C835	14	COB	1825	8"	210	240 55	0,75	16	5500
PLC2AY21C85	21	COB	2490	8"	210	240 55	0,75	16	5500
PLC2AY29C87	29	COB	3130	8"	210	240 55	0,75	16	5500

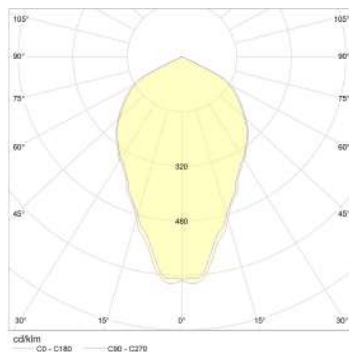
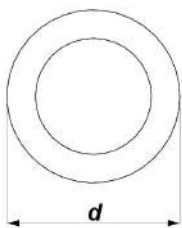
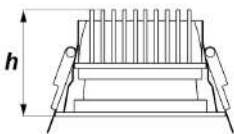

V / Hz 220 - 240 / 50 - 60

Options	Options
Dimmable electronic ballast or convertor.	Ballast électronique dimmable ou converteur.
Emergency kit for models with LED	Kit d'urgence pour les modèles LED.
NOTE	NOTE
Given lumen values are net delivered luminaire output lumens.	Les valeurs de lumens données sont les lumens de sortie nets du luminaire.
Given power values are total consumed AC power of the luminaire.	Les valeurs de puissance données sont la puissance AC totale consommée du luminaire.



## SLIM DOWNLIGHT

### LED

Recessed Slim Downlight

Encastré Slim Downlight

#### APPLICATION AREAS

Shopping Malls  
Supermarkets  
Offices  
Meeting rooms  
Stores  
Hospitals  
Schools  
Corridors

#### DOMAINES D'UTILISATION

Centres Commerciaux  
Supermarchés  
Bureaux  
Salles de Réunion  
Magasins  
Hopitaux  
Ecoles  
Couloirs

#### BODY

White or optional any type of finishing color aluminum body and effective cooling performance.

#### DIFFUSER

UV stabilized frosted diffuser.

#### CONVERTER

Long life, low power loss converter with constant current. Compatible with ENEC standards.

#### LED

LED modules with 60.000 hours lifetime LUMILEDS / SAMSUNG / CREE brand LEDs.

#### CORPS

Blanc ou facultatif n'importe quel type de corps en aluminium de couleur de finition et exécution efficace de refroidissement.

#### DIFFUSEUR

Diffuseur en anti UV.

#### CONVERTEUR

Convertisseur, conforme aux normes ENEC. Longue vie. Perte de puissance faible avec courant constant .

#### LED

Modules LED – Durée de vie 60.000 heures avec LED de marque LUMILEDS / SAMSUNG / CREE.



LED Type / Type LED

Color Rendering Index / Indice de Rendu des Couleurs: (CRI): Ra>80

Code	Power Puissance (W)	Led Type Type De Led	Lum. Flux Flux Lum. (lm)	Frame Flange Type Type de Bride de Cadre	Ceiling Cut (mm) Coupe de Plafond	Dimensions (mm) d h		Weight Poids (kg)	Packing Quantity Colisage	Pcs./20" Container Pcs./20" Conteneur
PLDS1AY10C325	10	2835 SMD	505	3"	105	128	25	0,17	36	21420
PLDS1AY11C425	11	2835 SMD	580	4"	130	150	25	0,39	36	14040
PLDS1AY15C435	15	2835 SMD	765	4"	130	150	25	0,39	36	14040
PLDS1AY19C65	19	2835 SMD	1035	6"	180	200	25	0,50	16	7640
PLDS1AY27C67	27	2835 SMD	1380	6"	180	200	25	0,50	16	7640

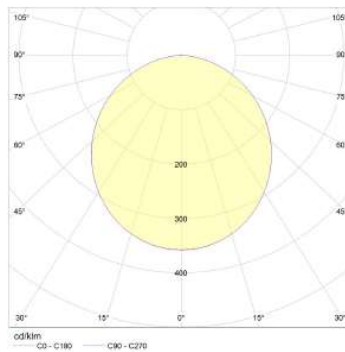
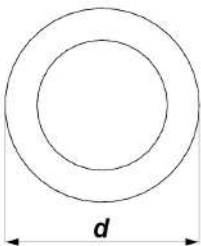
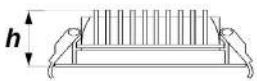

V / Hz 220 - 240 / 50 - 60

Options	Options
Dimmable electronic ballast or convertor. Emergency kit for models with LED	Ballast électronique dimmable ou convertor. Kit d'urgence pour les modèles LED.
<b>NOTE</b> Given lumen values are net delivered luminaire output lumens.  Given power values are total consumed AC power of the luminaire.	<b>NOTE</b> Les valeurs de lumens données sont les lumens de sortie nets du luminaire.  Les valeurs de puissance données sont la puissance AC totale consommée du luminaire.





## DOWNLIGHT

# LED

## Recessed Slim Downlight

## Encastré Slim Downlight

### APPLICATION AREAS

Shopping Malls  
Supermarkets  
Offices  
Meeting rooms  
Stores  
Hospitals  
Schools  
Corridors

### DOMAINES D'UTILISATION

Centres Commerciaux  
Supermarchés  
Bureaux  
Salles de Réunion  
Magasins  
Hopitaux  
Ecoles  
Couloirs

#### BODY

White or optional any type of finishing color aluminum body and effective cooling performance.

#### DIFFUSER

UV stabilized frosted diffuser.

#### CONVERTER

Long life, low power loss converter with constant current. Compatible with ENEC standards.

#### LED

LED modules with 60.000 hours lifetime LUMILEDS / SAMSUNG / CREE brand LEDs.

#### CORPS

Blanc ou facultatif n'importe quel type de corps en aluminium de couleur de finition et exécution efficace de refroidissement.

#### DIFFUSEUR

Diffuseur en anti UV.

#### CONVERTEUR

Convertisseur, conforme aux normes ENEC. Longue vie. Perte de puissance faible avec courant constant .

#### LED

Modules LED – Durée de vie 60.000 heures avec LED de marque LUMILEDS / SAMSUNG / CREE.



LED Type / Type LED

Color Rendering Index / Indice de Rendu des Couleurs: (CRI): Ra>80

Code	Power Puissance (W)	Led Type Type De Led	Lum. Flux Flux Lum. (lm)	Frame Flange Type Type de Bride de Cadre	Ceiling Cut (mm) Coupe de Plafond	Dimensions (mm) d h		Weight Poids (kg)	Packing Quantity Colisage	Pcs./20" Container Pcs./20" Conteneur
PLD1AY09C25	9	2835 SMD	590	2"	85	97	55	0,21	48	28560
PLD1AY10C325	10	2835 SMD	670	3"	105	117	50	0,27	36	21420
PLD1AY14C335	14	2835 SMD	860	3"	105	117	50	0,27	36	21420
PLD1AY11C425	11	2835 SMD	785	4"	130	147	55	0,39	36	14040
PLD1AY15C435	15	2835 SMD	1045	4"	130	147	55	0,44	36	14040
PLD1AY11C525	11	2835 SMD	900	5"	160	175	58	0,55	16	8640
PLD1AY15C535	15	2835 SMD	1200	5"	160	175	58	0,55	16	8640
PLD1AY19C65	19	2835 SMD	1555	6"	175	192	55	0,64	16	7640
PLD1AY27C67	27	2835 SMD	2040	6"	175	192	55	0,64	16	7640
PLD1AY19C85	19	2835 SMD	1635	8"	210	227	58	0,95	16	6240
PLD1AY27C87	27	2835 SMD	2150	8"	210	227	58	0,95	16	6240
PLD1AY30C89	30	2835 SMD	2590	8"	210	227	58	0,95	16	6240

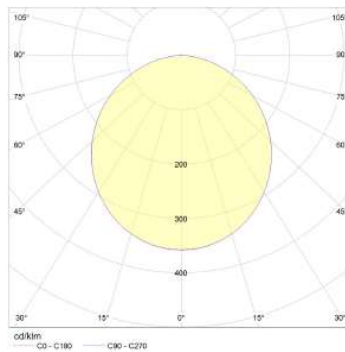
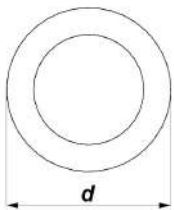
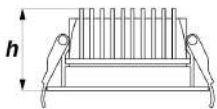

V / Hz 220 - 240 / 50 - 60

Options	Options
Dimmable electronic ballast or convertor.	Ballast électronique dimmable ou converteur.
Emergency kit for models with LED	Kit d'urgence pour les modèles LED.
NOTE	NOTE
Given lumen values are net delivered luminaire output lumens.	Les valeurs de lumens données sont les lumens de sortie nets du luminaire.
Given power values are total consumed AC power of the luminaire.	Les valeurs de puissance données sont la puissance AC totale consommée du luminaire.



**DOWNLIGHT**

# LED

Recessed Downlight

Encastré Downlight

## APPLICATION AREAS

Shopping Malls  
Supermarkets  
Offices  
Meeting rooms  
Stores  
Hospitals  
Schools  
Corridors

## DOMAINES D'UTILISATION

Centres Commerciaux  
Supermarchés  
Bureaux  
Salles de Réunion  
Magasins  
Hopitaux  
Ecoles  
Couloirs

### BODY

White or optional any type of finishing color aluminum body and effective cooling performance.

### DIFFUSER

UV stabilized frosted diffuser.

### CONVERTER

Long life, low power loss converter with constant current. Compatible with ENEC standards.

### LED

LED modules with 60.000 hours lifetime LUMILEDS / SAMSUNG / CREE brand LEDs.

### CORPS

Blanc ou facultatif n'importe quel type de corps en aluminium de couleur de finition et exécution efficace de refroidissement.

### DIFFUSEUR

Diffuseur en anti UV.

### CONVERTEUR

Convertisseur, conforme aux normes ENEC. Longue vie. Perte de puissance faible avec courant constant .

### LED

Modules LED – Durée de vie 60.000 heures avec LED de marque LUMILEDS / SAMSUNG / CREE.



## LED Type / Type LED

Color Rendering Index / Indice de Rendu des Couleurs: (CRI): Ra>80

Code	Power Puissance (W)	Led Type Type De Led	Lum. Flux Flux Lum. (lm)	Frame Flange Type Type de Bride de Cadre	Ceiling Cut (mm) Coupe de Plafond	Dimensions (mm) d h		Weight Poids (kg)	Packing Quantity Colisage	Pcs./20" Container Pcs./20" Conteneur
PLD2AY09C225	9	2835 SMD	580	2"	85	108	55	0,21	48	28560
PLD2AY10C325	10	2835 SMD	670	3"	105	130	50	0,27	36	21420
PLD2AY14C335	14	2835 SMD	845	3"	105	130	50	0,27	36	21420
PLD2AY11C425	11	2835 SMD	770	4"	130	150	55	0,39	36	14040
PLD2AY15C435	15	2835 SMD	1020	4"	130	150	55	0,44	36	14040
PLD2AY11C525	11	2835 SMD	880	5"	165	180	58	0,55	16	8640
PLD2AY15C535	15	2835 SMD	1195	5"	165	180	58	0,55	16	8640
PLD2AY19C65	19	2835 SMD	1545	6"	180	200	55	0,64	16	7640
PLD2AY27C67	27	2835 SMD	2010	6"	180	200	55	0,64	16	7640
PLD2AY19C85	19	2835 SMD	1640	8"	210	240	58	0,95	16	6240
PLD2AY27C87	27	2835 SMD	2135	8"	210	240	58	0,95	16	6240
PLD2AY30C89	30	2835 SMD	2600	8"	210	240	58	0,95	16	6240

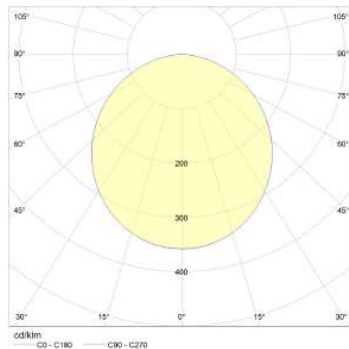
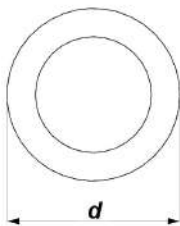
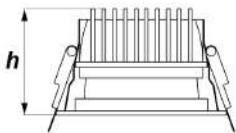

V / Hz 220 - 240 / 50 - 60

Options	Options
Dimmable electronic ballast or convertor.	Ballast électronique dimmable ou converteur.
Emergency kit for models with LED	Kit d'urgence pour les modèles LED.
<b>NOTE</b>	<b>NOTE</b>
Given lumen values are net delivered luminaire output lumens.	Les valeurs de lumens données sont les lumens de sortie nets du luminaire.
Given power values are total consumed AC power of the luminaire.	Les valeurs de puissance données sont la puissance AC totale consommée du luminaire.



## DOWNLIGHT

### LED

Recessed Downlight

Encastré Downlight

#### APPLICATION AREAS

Shopping Malls  
Supermarkets  
Offices  
Meeting rooms  
Stores  
Hospitals  
Schools  
Corridors

#### DOMAINES D'UTILISATION

Centres Commerciaux  
Supermarchés  
Bureaux  
Salles de Réunion  
Magasins  
Hopitaux  
Ecoles  
Couloirs

#### BODY

White or optional any type of finishing color aluminum body and effective cooling performance.

#### DIFFUSER

UV stabilized frosted diffuser.

#### CONVERTER

Long life, low power loss converter with constant current. Compatible with ENEC standards.

#### LED

LED modules with 60.000 hours lifetime LUMILEDS / SAMSUNG / CREE brand LEDs.

#### CORPS

Blanc ou facultatif n'importe quel type de corps en aluminium de couleur de finition et exécution efficace de refroidissement.

#### DIFFUSEUR

Diffuseur en anti UV.

#### CONVERTEUR

Convertisseur, conforme aux normes ENEC. Longue vie. Perte de puissance faible avec courant constant .

#### LED

Modules LED – Durée de vie 60.000 heures avec LED de marque LUMILEDS / SAMSUNG / CREE.



LED Type / Type LED

Color Rendering Index / Indice de Rendu des Couleurs: (CRI): Ra>80

Code	Power Puissance (W)	Led Type Type De Led	Lum. Flux Flux Lum. (lm)	Frame Flange Type Type de Bride de Cadre	Ceiling Cut (mm) Coupe de Plafond	Dimensions (mm) a h	Weight Poids (kg)	Packing Quantity Colisage	Pcs./20" Container Pcs./20" Conteneur
PLD1AK09C225	9	2835 SMD	590	2"	85	97 55	0,21	48	28560
PLD1AK10C325	10	2835 SMD	670	3"	105	117 50	0,27	36	21420
PLD1AK14C335	14	2835 SMD	860	3"	105	117 50	0,27	36	21420
PLD1AK11C425	11	2835 SMD	785	4"	130	147 55	0,39	36	14040
PLD1AK15C435	15	2835 SMD	1045	4"	130	147 55	0,44	36	14040
PLD1AK11C525	11	2835 SMD	900	5"	160	175 58	0,55	16	8640
PLD1AK15C535	15	2835 SMD	1200	5"	160	175 58	0,55	16	8640
PLD1AK19C65	19	2835 SMD	1555	6"	175	192 55	0,64	16	7640
PLD1AK27C67	27	2835 SMD	2040	6"	175	192 55	0,64	16	7640
PLD1AK19C85	19	2835 SMD	1635	8"	210	227 58	0,95	16	6240
PLD1AK27C87	27	2835 SMD	2150	8"	210	227 58	0,95	16	6240
PLD1AK30C89	30	2835 SMD	2590	8"	210	227 58	0,95	16	6240

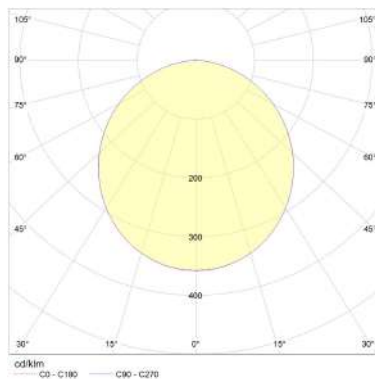
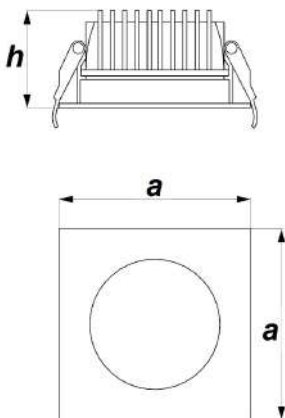

V / Hz 220 - 240 / 50 - 60

Options	Options
Dimmable electronic ballast or convertor.	Ballast électronique dimmable ou converteur.
Emergency kit for models with LED	Kit d'urgence pour les modèles LED.
NOTE	NOTE
Given lumen values are net delivered luminaire output lumens.	Les valeurs de lumens données sont les lumens de sortie nets du luminaire.
Given power values are total consumed AC power of the luminaire.	Les valeurs de puissance données sont la puissance AC totale consommée du luminaire.

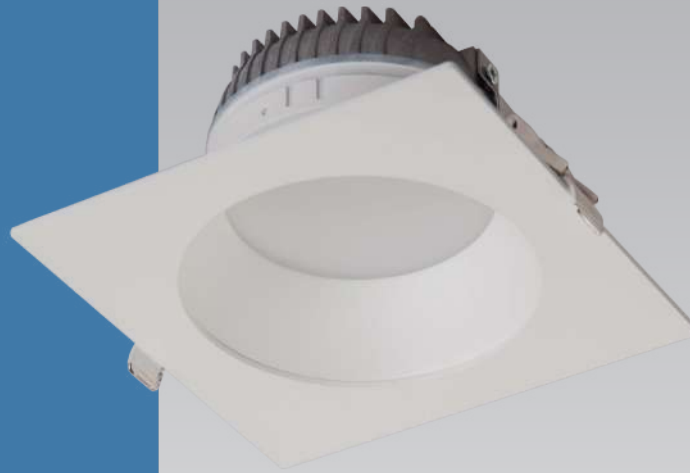

## DOWNLIGHT

# LED

Recessed Downlight

Encastré Downlight

### APPLICATION AREAS

Shopping Malls  
Supermarkets  
Offices  
Meeting rooms  
Stores  
Hospitals  
Schools  
Corridors

### DOMAINES D'UTILISATION

Centres Commerciaux  
Supermarchés  
Bureaux  
Salles de Réunion  
Magasins  
Hopitaux  
Ecoles  
Couloirs

#### BODY

White or optional any type of finishing color aluminum body and effective cooling performance.

#### DIFFUSER

UV stabilized frosted diffuser.

#### CONVERTER

Long life, low power loss converter with constant current. Compatible with ENEC standards.

#### LED

LED modules with 60.000 hours lifetime LUMILEDS / SAMSUNG / CREE brand LEDs.

#### CORPS

Blanc ou facultatif n'importe quel type de corps en aluminium de couleur de finition et exécution efficace de refroidissement.

#### DIFFUSEUR

Diffuseur en anti UV.

#### CONVERTEUR

Convertisseur, conforme aux normes ENEC. Longue vie. Perte de puissance faible avec courant constant .

#### LED

Modules LED – Durée de vie 60.000 heures avec LED de marque LUMILEDS / SAMSUNG / CREE.



LED Type / Type LED

Color Rendering Index / Indice de Rendu des Couleurs: (CRI): Ra>80

Code	Power Puissance (W)	Led Type Type De Led	Lum. Flux Flux Lum. (lm)	Frame Flange Type Type de Bride de Cadre	Ceiling Cut (mm) Coupe de Plafond	Dimensions (mm) b h		Weight Poids (kg)	Packing Quantity Colisage	Pcs./20" Container Pcs./20" Conteneur
PLD2AK09C225	9	2835 SMD	580	2"	85	97	70	0,30	48	28560
PLD2AK10C325	10	2835 SMD	660	3"	105	117	70	0,40	36	21420
PLD2AK11C425	11	2835 SMD	770	4"	130	147	75	0,40	36	14040
PLD2AK11C525	11	2835 SMD	1020	5"	160	175	85	0,60	16	8640
PLD2AK15C535	15	2835 SMD	1400	5"	160	175	85	0,60	16	8640
PLD2AK11C625	11	2835 SMD	1550	6"	175	192	85	0,70	16	7640
PLD2AK15C635	15	2835 SMD	1700	6"	175	192	85	0,70	16	7640
PLD2AK19C85	19	2835 SMD	1845	8"	210	227	85	1,10	16	6240
PLD2AK27C87	27	2835 SMD	2135	8"	210	227	85	1,10	16	6240

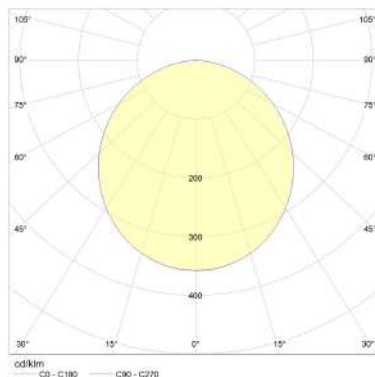
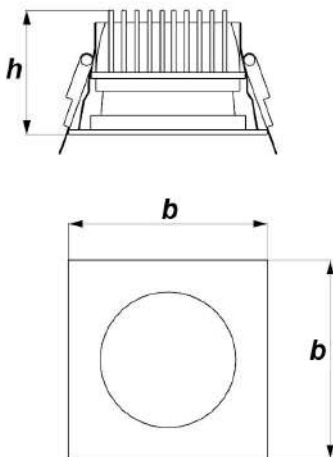

V / Hz 220 - 240 / 50 - 60

Options	Options
Dimmable electronic ballast or convertor.	Ballast électronique dimmable ou converteur.
Emergency kit for models with LED	Kit d'urgence pour les modèles LED.
NOTE	NOTE
Given lumen values are net delivered luminaire output lumens.	Les valeurs de lumens données sont les lumens de sortie nets du luminaire.
Given power values are total consumed AC power of the luminaire.	Les valeurs de puissance données sont la puissance AC totale consommée du luminaire.





## DOWNLIGHT

### LED

#### Surface Mounted Downlight

#### Downlight Apparents

#### APPLICATION AREAS

Shopping Malls  
Supermarkets  
Offices  
Meeting rooms  
Stores  
Hospitals  
Schools  
Corridors

#### DOMAINES D'UTILISATION

Centres Commerciaux  
Supermarchés  
Bureaux  
Salles de Réunion  
Magasins  
Hopitaux  
Ecoles  
Couloirs

#### BODY

Aluminum profile frame and injection head.

#### REFLECTOR

High-purity aluminum reflector; narrow, medium and wide angle options.

#### CONVERTER

Long life, low power loss converter with constant current. Compatible with ENEC standards.

#### LED

LED modules with 60.000 hours lifetime SAMSUNG / OSRAM / PHILIPS brand LEDs.

#### CORPS

Profilé en aluminium et tête d'injection.

#### REFLECTEUR

Réflecteur en aluminium de haute pureté; options d'angle étroit, moyen et large.

#### CONVERTEUR

Convertisseur, conforme aux normes ENEC. Longue vie. Perte de puissance faible avec courant constant.

#### LED

Modules LED – Durée de vie 60.000 heures avec LED de marque SAMSUNG / OSRAM / PHILIPS.



LED Type / Type LED

Color Rendering Index / Indice de Rendu des Couleurs: (CRI): Ra>80

Code	Power Puissance (W)	Led Type Type De Led	Lum. Flux Flux Lum. (lm)	Color Temperature Température De Couleur (K)	Dimensions (mm)		Weight Poids (kg)	Packing Quantity Colisage	Pcs./20" Container Pcs./20" Conteneur
					a	h			
PLD2U21C	21	COB	1910	2700 - 6500	118	245	1,75	24	6270
PLD2U28C	28	COB	2870	2700 - 6500	118	245	1,75	24	6270

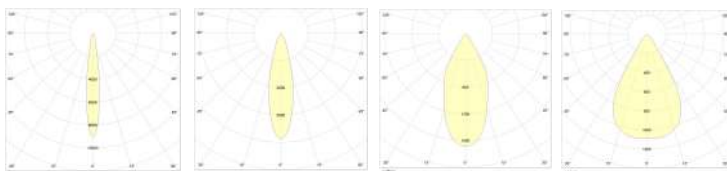
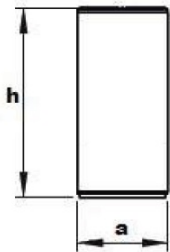

15° Reflector

30° Reflector

45° Reflector

60° Reflector

V / Hz 220 - 240 / 50 - 60

Options	Options
Dimmable electronic ballast or convertor.	Ballast électronique dimmable ou converteur.
Emergency kit for models with LED	Kit d'urgence pour les modèles LED.

NOTE	NOTE
Given lumen values are net delivered luminaire output lumens.	Les valeurs de lumens données sont les lumens de sortie nets du luminaire.
Given power values are total consumed AC power of the luminaire.	Les valeurs de puissance données sont la puissance AC totale consommée du luminaire.



## DOWNLIGHT

### LED

Recessed Downlight

Encastré Downlight

#### APPLICATION AREAS

Shopping Malls  
Supermarkets  
Offices  
Meeting rooms  
Stores  
Hospitals  
Schools  
Corridors

#### DOMAINES D'UTILISATION

Centres Commerciaux  
Supermarchés  
Bureaux  
Salles de Réunion  
Magasins  
Hopitaux  
Ecoles  
Couloirs

#### BODY

Aluminum profile frame and injection head.

#### REFLECTOR

High-purity aluminum reflector; narrow, medium and wide angle options.

#### CONVERTER

Long life, low power loss converter with constant current. Compatible with ENEC standards.

#### LED

LED modules with 60.000 hours lifetime SAMSUNG / OSRAM / PHILIPS brand LEDs.

#### CORPS

Profilé en aluminium et tête d'injection.

#### REFLECTEUR

Réflecteur en aluminium de haute pureté; options d'angle étroit, moyen et large.

#### CONVERTEUR

Convertisseur, conforme aux normes ENEC. Longue vie. Perte de puissance faible avec courant constant.

#### LED

Modules LED – Durée de vie 60.000 heures avec LED de marque SAMSUNG / OSRAM / PHILIPS.



## LED Type / Type LED

Color Rendering Index / Indice de Rendu des Couleurs: (CRI): Ra>80

Code	Power Puissance (W)	Led Type Type De Led	Lum. Flux Flux Lum. (lm)	Color Temperature Température De Couleur (K)	Ceiling Cut (mm) Coupe de Plafond	Dimensions (mm) a h		Weight Poids (kg)	Packing Quantity Colisage	Pcs./20" Container Pcs./20" Conteneur
PLC3A21C	21	COB	1910	2700 - 6500	170	185	146	0,75	24	4770
PLC3A28C	28	COB	2870	2700 - 6500	170	185	146	0,75	24	4770
PLC3A36C	36	COB	3420	2700 - 6500	170	185	146	0,75	24	4770

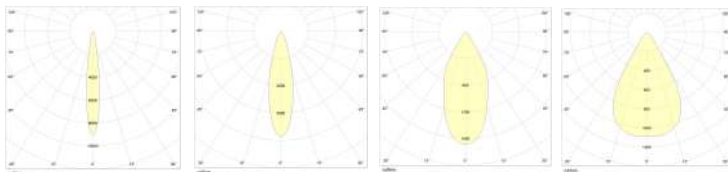
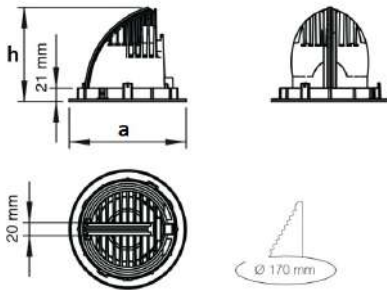

15° Reflector

30° Reflector

45° Reflector

60° Reflector

V / Hz 220 - 240 / 50 - 60

Options	Options
Dimmable electronic ballast or convertor.	Ballast électronique dimmable ou converteur.
Emergency kit for models with LED	Kit d'urgence pour les modèles LED.
NOTE	NOTE
Given lumen values are net delivered luminaire output lumens.	Les valeurs de lumens données sont les lumens de sortie nets du luminaire.
Given power values are total consumed AC power of the luminaire.	Les valeurs de puissance données sont la puissance AC totale consommée du luminaire.



## DOWNLIGHT

### LED

#### Adjustable Recessed Downlight

#### Réglable Encastrés Downlight

#### APPLICATION AREAS

Shopping Malls  
Supermarkets  
Offices  
Meeting rooms  
Stores  
Hospitals  
Schools  
Corridors

#### DOMAINES D'UTILISATION

Centres Commerciaux  
Supermarchés  
Bureaux  
Salles de Réunion  
Magasins  
Hopitaux  
Ecoles  
Couloirs

#### BODY

Aluminum profile frame and injection head.

#### REFLECTOR

High-purity aluminum reflector; narrow, medium and wide angle options.

#### CONVERTER

Long life, low power loss converter with constant current. Compatible with ENEC standards.

#### LED

LED modules with 60.000 hours lifetime SAMSUNG / OSRAM / PHILIPS brand LEDs.

#### CORPS

Profilé en aluminium et tête d'injection.

#### REFLECTEUR

Réflecteur en aluminium de haute pureté; options d'angle étroit, moyen et large.

#### CONVERTEUR

Convertisseur, conforme aux normes ENEC. Longue vie. Perte de puissance faible avec courant constant.

#### LED

Modules LED – Durée de vie 60.000 heures avec LED de marque SAMSUNG / OSRAM / PHILIPS.

V / Hz		220 - 240 / 50 - 60		NOTE	NOTE
<b>Options</b>	<b>Options</b>			Given lumen values are net delivered luminaire output lumens.	Les valeurs de lumens données sont les lumens de sortie nets du luminaire.
Dimmable electronic ballast or convertor.	Ballast électronique dimmable ou convertor.			Given power values are total consumed AC power of the luminaire.	Les valeurs de puissance données sont la puissance AC totale consommée du luminaire.
Emergency kit for models with LED	Kit d'urgence pour les modèles LED.				



LED Type / Type LED

Color Rendering Index / Indice de Rendu des Couleurs: (CRI): Ra>80

Code	Power Puissance (W)	Led Type Type De Led	Lum. Flux Flux Lum. (lm)	Color Temperature Température De Couleur (K)	Ceiling Cut (mm) Coupe de Plafond	Dimensions (mm)			Weight Poids (kg)	Packing Quantity Colisage	Pcs./20" Container Pcs./20" Conteneur
						a	b	h			
PLC2A128C	28	COB	2870	2700 - 6500	160x160	190	190	119	1,50	24	5300
PLC2A136C	36	COB	3420	2700 - 6500	160x160	190	190	119	1,50	24	5300
PLC2A228C	56	COB	5740	2700 - 6500	330x160	360	190	119	3,20	12	1550
PLC2A236C	72	COB	6840	2700 - 6500	330x160	360	190	119	3,20	12	1550
PLC2A328C	84	COB	8610	2700 - 6500	500x160	530	190	119	4,70	8	730
PLC2A336C	108	COB	10260	2700 - 6500	500x160	530	190	119	4,70	8	730

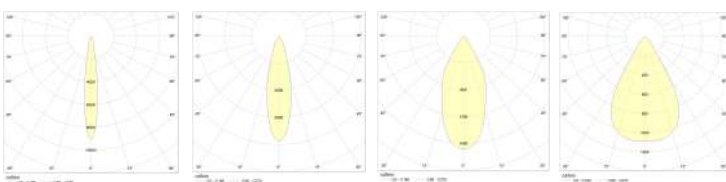
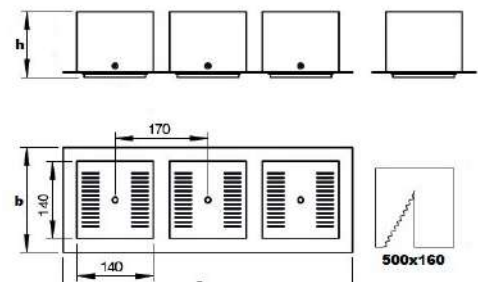
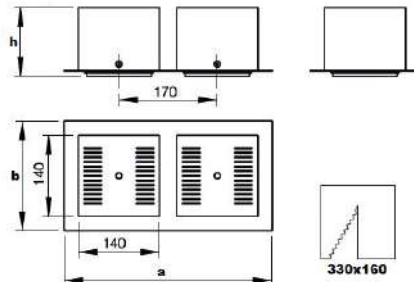
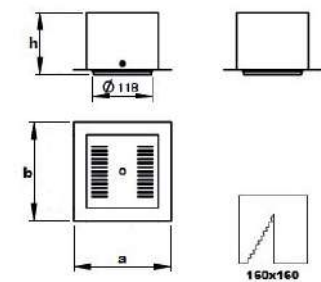

15° Reflector

30° Reflector

45° Reflector

60° Reflector



## DOWNLIGHT

### LED

#### Adjustable Surface Mounted Downlight

#### Réglable Apparents Downlight

#### APPLICATION AREAS

Shopping Malls  
Supermarkets  
Offices  
Meeting rooms  
Stores  
Hospitals  
Schools  
Corridors

#### DOMAINES D'UTILISATION

Centres Commerciaux  
Supermarchés  
Bureaux  
Salles de Réunion  
Magasins  
Hopitaux  
Ecoles  
Couloirs

#### BODY

Aluminum profile frame and injection head.

#### REFLECTOR

High-purity aluminum reflector; narrow, medium and wide angle options.

#### CONVERTER

Long life, low power loss converter with constant current. Compatible with ENEC standards.

#### LED

LED modules with 60.000 hours lifetime SAMSUNG / OSRAM / PHILIPS brand LEDs.

#### CORPS

Profilé en aluminium et tête d'injection.

#### REFLECTEUR

Réflecteur en aluminium de haute pureté; options d'angle étroit, moyen et large.

#### CONVERTEUR

Convertisseur, conforme aux normes ENEC. Longue vie. Perte de puissance faible avec courant constant.

#### LED

Modules LED – Durée de vie 60.000 heures avec LED de marque SAMSUNG / OSRAM / PHILIPS.

V / Hz 220 - 240 / 50 - 60

Options	Options	NOTE	NOTE
Dimmable electronic ballast or convertor.	Ballast électronique dimmable ou converteur.	Given lumen values are net delivered luminaire output lumens.	Les valeurs de lumens données sont les lumens de sortie nets du luminaire.
Emergency kit for models with LED	Kit d'urgence pour les modèles LED.	Given power values are total consumed AC power of the luminaire.	Les valeurs de puissance données sont la puissance AC totale consommée du luminaire.



LED Type / Type LED

Color Rendering Index / Indice de Rendu des Couleurs: (CRI): Ra>80

Code	Power Puissance (W)	Led Type Type De Led	Lum. Flux Flux Lum. (lm)	Color Temperature Température De Couleur (K)	Dimensions (mm)			Weight Poids (kg)	Packing Quantity Colisage	Pcs./20" Container Pcs./20" Conteneur
					a	b	h			
PLD3U09C	9	COB	630	2700 - 6500	97	97	100	1,50	24	20710
PLD3U17C	17	COB	1255	2700 - 6500	197	97	100	3,20	12	10850
PLD3U25C	25	COB	1890	2700 - 6500	292	97	100	4,70	8	7350

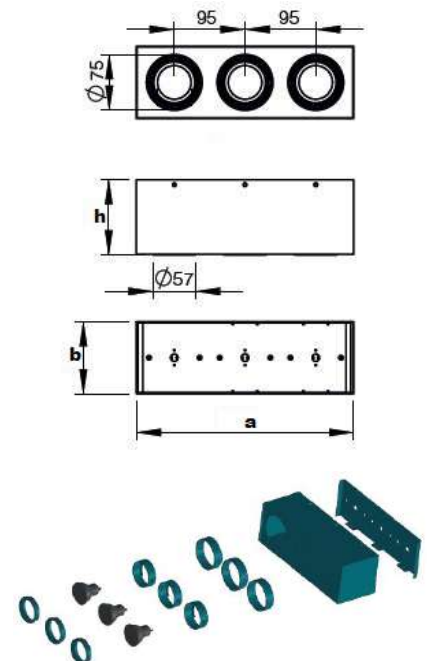
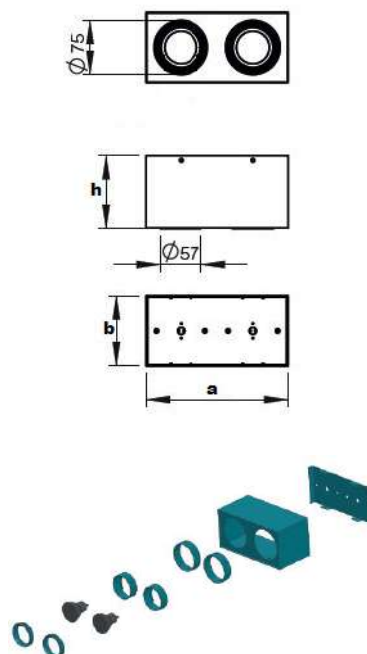
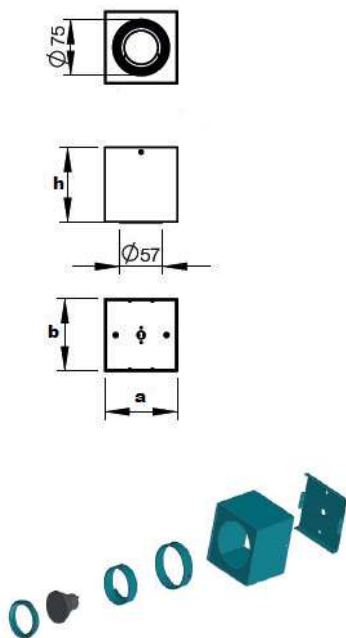





 **pamir**<sup>®</sup>  
aydinlatma



**METAL GLOP**



## UFO GLOP

### LED

#### Glop Lamps

#### Hublots

#### APPLICATION AREAS

Building entrances  
Stairways  
Corridors  
All other necessary places

#### DOMAINES D'UTILISATION

Entrées de bâtiment  
Escaliers  
Corridors  
Et tout autre lieu si nécessaire

#### BODY

RAL 9016 electrostatic powder coated sheetmetal.

#### GLASS

Frosted glass.

#### LED (For LED Models)

LED modules with 60.000 hours lifetime.

#### CORPS

RAL 9016 Feuille de métal peinte électrostatiquement.

#### VERRE

Verre givré.

#### LED (Pour Modèles LED)

Modules LED – Durée de vie 60.000 heures.



### Bulb Type / Type d'ampoule (E-27)

Code	Power Puissance (W)	Color Couleur	Weight Poids (kg)	Socket Type Type De Douille	Dimensions (mm)		Packing Quantity Colisage	Pcs./20" Container Pcs./20" Conteneur
					D	h		
GLS-20	1x60	White/Blanc	1.1	1xE-27	280	68	12	4700

### LED Type / Type LED

Code	Power Puissance (W)	Color Couleur	Weight Poids (kg)	LED Type Type De LED	Dimensions (mm)		Packing Quantity Colisage	Pcs./20" Container Pcs./20" Conteneur
					D	h		
GLS-29	12	White/Blanc	1.0	2835 SMD	280	68	12	4700
GLS-30	24	White/Blanc	1.0	2835 SMD	280	68	12	4700

V / Hz 220 - 240 / 50 - 60

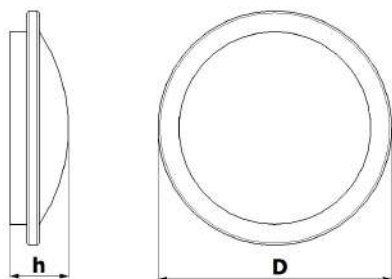

NOTE	NOTE
Given lumen values are net delivered luminaire output lumens.	Les valeurs de lumens données sont les lumens de sortie nets du luminaire.
Given power values are total consumed AC power of the luminaire.	Les valeurs de puissance données sont la puissance AC totale consommée du luminaire.



 **pamir**<sup>®</sup>  
aydınlatma





**SENSOR / DÉTECTEUR**





SGS 30



SGS 10 - SGS 20

## LED / E27

### Motion Sensor Lamp

### Hublot Avec Détecteur De Mouvement

#### APPLICATION AREAS

Building entrances  
Stairways  
Corridors  
All other necessary places

#### DOMAINES D'UTILISATION

Entrées de bâtiment  
Escaliers  
Corridors  
Et tout autre lieu si nécessaire

#### BODY

RAL 9016 electrostatic powder coated sheetmetal.

#### DIFFUSER

UV stabilized frosted diffuser.

#### LED (For LED Models)

LED modules with 60.000 hours lifetime.

#### CORPS

RAL 9016 Feuille de métal peinte électrostatiquement.

#### DIFFUSEUR

Diffuseur en anti UV.

#### LED (Pour Modèles LED)

Modules LED – Durée de vie 60.000 heures.



### Bulb Type / Type d'ampoule (E-27)

Code	Power Puissance (W)	Weight Poids (kg)	Socket Type Type De Douille	Dimensions (mm) d h		Packing Quantity Colisage	Pcs./20" Container Pcs./20" Conteneur
SGS-10	2x15	1.1	2xE-27	300	105	12	3100
SGS-10K	2x15	1.2	2xE-27	300	105	12	3100

### LED Type / Type LED

Code	Power Puissance (W)	Weight Poids (kg)	LED Type Type De LED	Dimensions (mm) d h		Packing Quantity Colisage	Pcs./20" Container Pcs./20" Conteneur
SGS 20	18	1.0	2835 SMD	300	105	12	3100
SGS 20K	18	1.1	2835 SMD	300	105	12	3100
SGS 30	18	1.0	2835 SMD	300	60	12	3100
SGS 30K	18	1.1	2835 SMD	300	60	12	3100

Options	Options
Emergency kit with led.	Kit d'urgence avec led.

Technical Specifications	Spécifications Techniques
Voltage: 230V ~ 50 Hz Detection Angle: 360° Optimum Mounting Height: 3m ± 20cm Detection Width: 9m ± 40cm Time Setting: 15 - 45 sec	Voltage: 230V ~ 50 Hz Angle de Détection: 360° Hauteur Optimale de Montage: 3m ± 20cm Largeur de Détection: 9m ± 40cm Durée Réglable: 15 - 45 sec

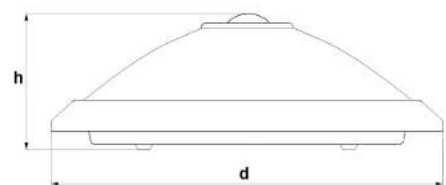

SGS10 - SGS10K - SGS20 - SGS 20K

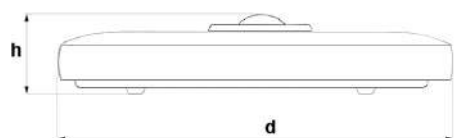

SGS30 - SGS 30K





## Motion Sensor

## Détecteur De Mouvement

### APPLICATION AREAS

Building entrances  
Stairways  
Corridors  
All other necessary places

### DOMAINES D'UTILISATION

Entrées de bâtiment  
Escaliers  
Corridors  
Et tout autre lieu si nécessaire

Code	Dimensions (mm)		Pcs / Inner Packing Pcs / Emballage Interne	Pcs / Outer Packing Pcs / Emballage Externe	Pcs./20" Container Pcs./20" Conteneur	Body Corps
	d	h				
SN-10	112	52	1	24	31080	ABS

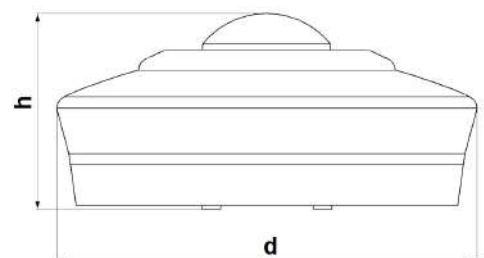



Technical Specifications	Spécifications Techniques
Voltage: 230V ~ 50 Hz IP 30 Power: Max 1500W (Incandescent Bulbs) Max 750W (Fluorescent Lamps) Detection Angle: 360° Optimum Mounting Height: 3m ± 20cm Detection Width: 14m ± 50 cm Time Setting: 8 sec - 8 min	Voltage: 230V ~ 50 Hz IP 30 Puissance: Max 1500W (Ampoules Incandescentes) Max 750W (Lampes Fluorescentes) Angle de Détection: 360° Hauteur Optimale de Montage: 3m + 20cm Largeur de Détection: 14m + 40 cm Durée Réglable: 8 sec - 8 min



SN 10





## Recessed Motion Sensor Encastré Détecteur De Mouvement

### APPLICATION AREAS

Building entrances  
Stairways  
Corridors  
All other necessary  
places

### DOMAINES D'UTILISATION

Entrées de bâtiment  
Escaliers  
Corridors  
Et tout autre lieu si  
nécessaire

Code	Dimensions (mm)		Pcs / Inner Packing Pcs / Emballage Interne	Pcs / Outer Packing Pcs / Emballage Externe	Pcs./20" Container Pcs./20" Conteneur	Body Corps
	d	h				
SN-20	133	65	1	24	31080	ABS

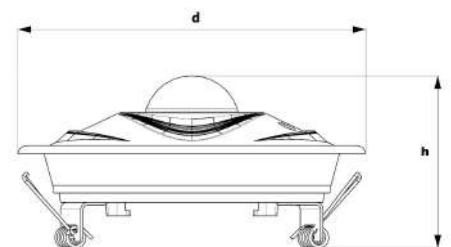



Technical Specifications	Spécifications Techniques
Voltage: 230V ~ 50 Hz IP 30 Power: Max 1500W (Incandescent Bulbs) Max 750W (Fluorescent Lamps) Detection Angle: 360° Optimum Mounting Height: 3m ± 20cm Detection Width: 8m ± 40 cm Time Setting: 8 sec - 8 min	Voltage: 230V ~ 50 Hz IP 30 Puissance: Max 1500W (Ampoules Incandescentes) Max 750W (Lampes Fluorescentes) Angle de Détection: 360° Hauteur Optimale de Montage: 3m ± 20cm Largeur de Détection: 8m ± 40 cm Durée Réglable: 8 sec - 8 min



SN 20



T.C.  
TÜRK PATENT ve MARKA KURUMU  
**MARKA YENİLEME BELGESİ**  
Marka No : 2011 03288 - Ticaret - Hizmet



Marka Sahibi : PAMİR ELEKTRİK SANAYİ VE TİCARET LİMİTED ŞİRKETİ  
TÜRKİYE CUMHURİYETİ  
Fetih Mah. Şeyhülëma Recep Ağa Cad. No:320 Karatay Konya  
Emtiası : 07 , 08 , 09 , 11 , 21 , 35  
İlişiktedir.

İşbu Marka ilk defa 14/01/2011 tarihinde tescil edilmiş olup, 14/01/2021 tarihinden itibaren ON YIL süreyle yenilenmiştir.

Prof. Dr. Habip ASAN  
Türk Patent ve Marka Kurumu Başkanı



T.C.  
TÜRK PATENT ve MARKA KURUMU  
**MARKA TESCİL BELGESİ**  
Marka No : 2017 55300 - Ticaret - Hizmet



Marka Sahibi : PAMİR ELEKTRİK SANAYİ VE TİCARET LİMİTED ŞİRKETİ  
TÜRKİYE CUMHURİYETİ  
Fetih Mah. Şeyhülëma Recep Ağa Cad. No:320 Karatay Konya  
Emtiası : 09 , 11 , 35  
İlişiktedir.

İşbu Marka 15/06/2017 tarihinden itibaren ON YIL süreyle 25/12/2017 tarihinde tescil edilmiştir.

Prof. Dr. Habip ASAN  
Türk Patent ve Marka Kurumu Başkanı



**artibel**

**SERTİFİKA**

Bu Sertifika ile

PAMİR ELEKTRİK SANAYİ VE TİCARET LİMİTED ŞİRKETİ

Fetih Mahallesi Şeyhülëma Repepağa Caddesi No:262  
Karatay / KONYA

Kuruluşunun

**ISO 9001:2015**

Şartlarına uygun bir Kalite Yönetim Sistemini aşağıdaki kapsamda uyguladığı teyit edilmiştir.

Aydınlatma Armatürleri, Balast, Otomatik Sigorta Kutuları  
Üretimi ve Satışı

Bu sertifika Artibel Belgelendirme şartlarına uyulması ve yılda en az bir kez yapılacak periyodik ara denetimlerde başarılı olunması halinde belgelendirme tarihinden itibaren üç yıl süreyle geçerlidir. Bu belgenin geçerliliği [www.artibel.com.tr](http://www.artibel.com.tr) adresinden doğrulanabilir.

EA Kodu : 19  
Sertifika No : Q585183715  
İlk Belgelendirme Tarihi : 27.10.2020  
Sertifika Tarihi : 09.11.2021  
Bitiş Tarihi : 26.10.2022  
Baskı No : 01



ONAY

ARTİBEL BELGELENDİRME TEKNİK KONTROL GÖZETİM VE EĞİTİM HİZMETLERİ LTD.ŞTİ.  
Alsancak Mahallesi 2066. Caddesi No:1/1 Etimesgut / ANKARA  
T/ +90 312 287 53 19 • +90 312 244 27 84 • [www.artibel.com.tr](http://www.artibel.com.tr) • [info@artibel.com.tr](mailto:info@artibel.com.tr)

**artibel**

**CERTIFICATE**

It is hereby certified that;

PAMİR ELEKTRİK SANAYİ VE TİCARET LİMİTED ŞİRKETİ

Fetih Mahallesi Şeyhülëma Repepağa Caddesi No:262  
Karatay / KONYA

Has been proved that the Quality Management System  
Which complies with the requirements of

**ISO 9001:2015**

Have been implemented for the scope described below

Lighting Fixtures, Ballast, Automatic Fuse Boxes Production and Sales

The validity of this certificate is dependent on complying with the Artibel Certification requirements and being successful in the surveillance audits which will be fulfilled at least once a year and this validity will last three years from the date of certification.

The validity of this certificate can be verified from [www.artibel.com.tr](http://www.artibel.com.tr)

EA Code : 19  
Certificate Number : Q585183715  
First Certification Date : 27.10.2020  
Certificate Date : 09.11.2021  
Expiration Date : 26.10.2022  
Printing Number : 01



APPROVAL

ARTİBEL BELGELENDİRME TEKNİK KONTROL GÖZETİM VE EĞİTİM HİZMETLERİ LTD.ŞTİ.  
Alsancak Mahallesi 2066. Caddesi No:1/1 Etimesgut / ANKARA  
T/ +90 312 287 53 19 • +90 312 244 27 84 • [www.artibel.com.tr](http://www.artibel.com.tr) • [info@artibel.com.tr](mailto:info@artibel.com.tr)





- [1] **TIP İNCELEME BELGESİ NUMARASI:** TSE 18ATEX0083  
*Type Examination Certificate Number:*
- [4] **TEÇHİZAT/EQUIPMENT:** Aydınlatma Armatürü, EAX X<sub>1</sub>X<sub>2</sub> Tipi  
*Luminaire, Type: EAX X<sub>1</sub>X<sub>2</sub>*
- [5] **ÜRETİCİ/MANUFACTURER:** Pamir Elektrik San. Ve Tic. Ltd. Şti.
- [6] **ADRES/ADDRESS:** Fetih Mah. Şeyhülislam Recepçağa Cad. No:262 Karatay Konya TÜRKİYE  
*This equipment and any acceptable variation thereto is specified in the schedule to this certificate and the documents therein referred to.*
- [8] Türk Standartları Enstitüsü(TSE); 2014/34/AB sayılı yönetmeliğin Ek II bölümünde verilen "Muhtemel Patlayıcı Ortamlarda Kullanılan Teçhizat veya Koruyucu Sistemlerin Tasarım ve Yapısına Dair Temel Sağlık ve Güvenlik Gereklilikleri"ne bu teçhizatın uygun olduğunu onaylar.  
*Turkish Standards Institute(TSE) certifies that this equipment or protective system has been found to comply with the Essential Health and Safety Requirements relating to the design of Category 3 equipment, which is intended for use in potentially explosive atmospheres. These Essential Health and Safety Requirements are given in Annex II to European Union Directive 2014/34/UE of 20 April 2016.*
- [9] İnceleme sonuçları aşağıdaki rapor ile kayıt altına alınmıştır.  
*The examination and test results are recorded in confidential Report No. 1563-ATEX-107/2018-01*
- [10] Temel sağlık ve güvenlik şartları gerekliliklerine uygunluk ekte belirtilenler hariç olmak üzere aşağıda belirtilen Standard(lar)a göre değerlendirilmiştir.  
*Compliance with the Essential Health and Safety Requirements, with the exception of those listed in the schedule of this certificate, has been assessed by reference to:*
- [11] Eğer "X" işareti belge numarasından sonra yer alıyorsa, bu teçhizat veya koruyucu sistemin belge ekinde belirtilmiş güvenli kullanımla ilgili özel şartları kapsadığını belirtir.  
*If the sign "X" is placed after the certificate number, it indicates that the equipment or protective system is subject to special conditions of safe use specified in the schedule to this certificate.*
- [12] 2014/34/AB Yönetmeliği EK III'e göre düzenlenen bu belge, teçhizat veya koruyucu sistemin tasarım, muayene ve testleriyle ilgilidir. Yönetmeliğin gereklilikleri üretimi sürecini ve bu teçhizatın veya koruyucu sisteminin tedarik edilmesini de kapsar ancak bu hususlar bu belgenin kapsamında değildir.  
*This Type Examination Certificate relates only to the design, examination and tests of the specified equipment or protective system in accordance to the directive 2014/34/UE. Further requirements of the Directive apply to the manufacturing process and supply of this equipment or protective system. These are not covered by this certificate.*
- [13] Teçhizatın veya koruyucu sistemin işaretlemesi aşağıdakileri içermelidir.  
*The marking of the equipment or protective system shall include the following:*

**Ex** II 3G Ex ec IIC T4 Gc  
-20 °C ≤ Tamb ≤ +40 °C  
IP 65

**SEZAI DOĞAN**  
Direktifler Müdürü  
Director of Directives  
28.03.2018



**Proje No/Project Number:** 1563-18/37049  
**Bu Tip İnceleme Belgesinin son geçerlilik tarihi:** 28.03.2023  
*This Type Examination Certificate is valid till:*

Bu belge sadece tamamını içerecek şekilde ve hiçbir değişiklik yapılmadan ekiyle birlikte çoğaltılabilir.  
*This certificate and its schedules may only be reproduced in its entirety and without any change.*

Sayfa/Page 1 / 2

[www.tse.org.tr](http://www.tse.org.tr) / Necatibey Cad. No: 112 Bakanlıklar - ANKARA / +90 312 416 62 00  
*This certificate cannot be altered, partially duplicated or copied for misunderstanding.*



- [14] **EK**
- [15] **Tip İnceleme Belgesi No:** TSE 18ATEX0083  
**TYPE EXAMINATION CERTIFICATE N°**
- [16] **Teçhizatın Tanımı/ Description of Equipment:**  
EAX serisi aydınlatma armatürü bir veya iki floresan lamba ile kullanılacak üzere tasarlanmış "nA" koruma tipine sahiptir. Plastik gövdeye sahip bir üründür.  
*EAX series luminaire has a "nA" protection type designed for use with one or two fluorescent lamps. It's a plastic bowl.*
- Tip İşaretlemesi/ Type Keying:**  
EAX X<sub>1</sub>X<sub>2</sub>
- | Model | Ampul sayısı (X <sub>1</sub> )<br># of lamp | X <sub>2</sub> Güç<br>Power | Ampul Türü<br>Lamp type | Güç (W)(X <sub>2</sub> )<br>Power |
|-------|---|-----------------------------|-------------------------|-----------------------------------|
| EAX   | 1   |                             | Floresan / fluorescent  | 18                                |
| EAX   | 2   |                             | Floresan / fluorescent  | 36                                |
| EAX   | 1   |                             | Floresan / fluorescent  | 36                                |
| EAX   | 2   |                             | Floresan / fluorescent  | 72                                |
| EAX   | 1   |                             | Floresan / fluorescent  | 54                                |
| EAX   | 2   |                             | Floresan / fluorescent  | 108                               |
- Çalışma Voltajı / Operating Voltage:** 220/230 Vac  
**Frekans / Frequency:** 50 Hz
- EAX tipi aydınlatma armatürlerinin teknik çizimleri [19]. Bölüm Dokümantasyon Listesinde verilmiştir.  
*EAX type luminaire's technical drawings are given in [19] List of Documentation.*

- [17] **Rapor Numaraları/ Test Reports:**  
Temel Gereklilik Raporu: : 1563-ATEX-107/2018-01  
*Essential Requirements Report*  
Muayene ve Deney Raporu: : TSE Ex Laboratuvarı 388722/02-18 nolu rapor  
*Test and Examination Report*  
TSE Ex laboratory 388722/02-18 numbered report
- [18] **Güvenli Kullanım için Özel Şartlar/ Special conditions for safe use:**  
Yoktur. None.
- [19] **Temel Sağlık ve Güvenlik Gereklilikleri/ Essential Health and Safety Requirements (EHSRs):**  
İlgili Temel Sağlık ve Güvenlik Gereklilikleri [10]. bölümde belirtilen standartlara göre sağlanmıştır.  
*The relevant EHSRs are covered by the standard mentioned in [10], according which the product was verified and in the manufacturer's instruction for use.*

[20] **Dokümantasyon Listesi / List of Documentation:**

Çizim No/ Drawing No:	Sayfa Sayısı # of page	Rev	Tarih/ Date	Adı/ Name
-	1	0	09.11.2017	EXPROOF ETANJİ TABAN / Bottom
-	1	0	09.11.2017	EXPROOF ETANJİ SAC / Sheet plate
-	1	0	09.11.2017	Elektrik Bağlantı Şeması / Electric circuit diagram
-	-	-	09.11.2017	Teknik dosya (11 Sayfa) / technical file (11 pages)

Bu belge sadece tamamını içerecek şekilde ve hiçbir değişiklik yapılmadan ekiyle birlikte çoğaltılabilir.  
*This certificate and its schedules may only be reproduced in its entirety and without any change.*

Veriliş Tarihi/ Date of issue: 28.03.2018

[www.tse.org.tr](http://www.tse.org.tr) / Necatibey Cad. No: 112 Bakanlıklar - ANKARA / +90 312 416 62 00 Sayfa/Page 2 / 2  
*This certificate cannot be altered, partially duplicated or copied for misunderstanding.*



- [1] **TIP İNCELEME BELGESİ NUMARASI:** TSE 21ATEX0173 X  
*Type Examination Certificate Number:*
- [4] **TEÇHİZAT/EQUIPMENT:** LED Aydınlatma Armatürü, EAXL serisi  
*LED Luminaire, Type: EAXL series*
- [5] **ÜRETİCİ/MANUFACTURER:** Pamir Elektrik Sanayi ve Ticaret Ltd. Şti.
- [6] **ADRES/ADDRESS:** Fetih Mah. Şeyhülislam Recep Ağa Cad. No:262 Karatay Konya
- [7] Bu teçhizatın veya koruyucu sisteminin kabul edilebilir tipleri, belge ekinde ve belirtilen dokümanlarda tanımlanmıştır.  
*This equipment and any acceptable variation thereto is specified in the schedule to this certificate and the documents therein referred to.*
- [8] Türk Standartları Enstitüsü(TSE); 2014/34/AB sayılı yönetmeliğin Ek II bölümünde verilen "Muhtemel Patlayıcı Ortamlarda Kullanılan Teçhizat veya Koruyucu Sistemlerin Tasarım ve Yapısına Dair Temel Sağlık ve Güvenlik Gereklilikleri"ne bu teçhizatın uygun olduğunu onaylar.  
*Turkish Standards Institute(TSE) certifies that this equipment or protective system has been found to comply with the Essential Health and Safety Requirements relating to the design of Category 3 equipment, which is intended for use in potentially explosive atmospheres. These Essential Health and Safety Requirements are given in Annex II to European Union Directive 2014/34/UE of 20 April 2016.*
- [9] İnceleme sonuçları aşağıdaki rapor ile kayıt altına alınmıştır.  
*The examination and test results are recorded in confidential Report No. 2729-ATEX-202/2021-01*
- [10] Temel sağlık ve güvenlik şartları gerekliliklerine uygunluk ekte belirtilenler hariç olmak üzere aşağıda belirtilen Standard(lar)a göre değerlendirilmiştir.  
*Compliance with the Essential Health and Safety Requirements, with the exception of those listed in the schedule of this certificate, has been assessed by reference to:*
- [11] Eğer "X" işareti belge numarasından sonra yer alıyorsa, bu teçhizat veya koruyucu sistemin belge ekinde belirtilmiş güvenli kullanımla ilgili özel şartları kapsadığını belirtir.  
*If the sign "X" is placed after the certificate number, it indicates that the equipment or protective system is subject to special conditions of safe use specified in the schedule to this certificate.*
- [12] 2014/34/AB Yönetmeliği EK III'e göre düzenlenen bu belge, teçhizat veya koruyucu sistemin tasarım, muayene ve testleriyle ilgilidir. Yönetmeliğin gereklilikleri üretimi sürecini ve bu teçhizatın veya koruyucu sisteminin tedarik edilmesini de kapsar ancak bu hususlar bu belgenin kapsamında değildir.  
*This Type Examination Certificate relates only to the design, examination and tests of the specified equipment or protective system in accordance to the directive 2014/34/UE. Further requirements of the Directive apply to the manufacturing process and supply of this equipment or protective system. These are not covered by this certificate.*
- [13] Teçhizatın veya koruyucu sistemin işaretlemesi aşağıdakileri içermelidir.  
*The marking of the equipment or protective system shall include the following:*

**Ex** II 3G Ex ec IIC T6 Gc  
-20 °C ≤ Tamb ≤ +40 °C, IP 65

**SEZAI DOĞAN**  
Ürün Belgelendirme Grup Başkanı  
Group Head of Product Certification Center  
28.12.2021



**Proje No/Project Number:** 2729-21/166341  
**Bu Tip İnceleme Belgesinin son geçerlilik tarihi:** 28.12.2026  
*This Type Examination Certificate is valid till:*

Bu belge sadece tamamını içerecek şekilde ve hiçbir değişiklik yapılmadan ekiyle birlikte çoğaltılabilir.  
*This certificate and its schedules may only be reproduced in its entirety and without any change.*

Sayfa/Page 1 / 2

[www.tse.org.tr](http://www.tse.org.tr) / Necatibey Cad. No: 112 Bakanlıklar - ANKARA / +90 312 416 62 00  
*This certificate cannot be altered, partially duplicated or copied for misunderstanding.*



- [14] **EK**
- [15] **Tip İnceleme Belgesi No:** TSE 21ATEX0173 X  
**TYPE EXAMINATION CERTIFICATE N°**
- [16] **Teçhizatın Tanımı/ Description of Equipment:**  
EAXL serisi LED aydınlatma armatürü Ex ec koruma tipine sahiptir. İECEXIBE19.0029U driver ile kullanılmaktadır. 1280 mm ve 670 mm olmak üzere iki boyutu vardır.  
*EAXL series LED luminaire has Ex ec protection type. It is used with the ICEXIBE19.0029U driver. It has two sizes, 1280 mm and 670 mm.*
- Tip İşaretlemesi/ Type Keying:**  
EAXL22L1SC = 26W LED BOY / Length:670mm En / Width:140mm H:102mm  
EAXL22L2SC = 41W LED BOY/ Length:670mm En/ Width:140mm H:102mm  
EAXL14L1SC = 26W LED BOY/ Length: 1280 mm En/ Width: 95 mm H:102mm  
EAXL14L2SC = 41W LED BOY/ Length: 1280 mm En/ Width: 95 mm H:102mm  
EAXL24L1SC = 53W LED BOY/ Length: 1280mm En/ Width:140mm H:102mm  
EAXL24L2SC = 80W LED BOY/ Length: 1280mm En/ Width:140mm H:102mm
- Çalışma Voltajı / Operating Voltage:** 220 Vac  
**Frekans / Frequency:** 50 Hz  
**Güç/Power:** 26-80 W

EAXL serisi aydınlatma armatürlerinin teknik çizimleri [19]. Bölüm Dokümantasyon Listesinde verilmiştir.  
*EAXL series type luminaire's technical drawings are given in [19] List of Documentation.*

- [17] **Rapor Numaraları/ Test Reports:**  
Temel Gereklilik Raporu: : 2729-ATEX-202/2021-01  
*Essential Requirements Report*  
Muayene ve Deney Raporu: : TSE Ex Laboratuvarı 645038/11-21 ve 645036/11-21 nolu raporlar  
*Test and Examination Report*  
TSE Ex laboratory 645038/11-21 and 645036/11-21 numbered reports
- [18] **Güvenli Kullanım için Özel Şartlar/ Special conditions for safe use:**  
Elektrostatik yük birikmesine karşı önlemler için talimatlar bakınız.  
*See instructions for precautions against electrostatic charge build-up.*
- [19] **Temel Sağlık ve Güvenlik Gereklilikleri/ Essential Health and Safety Requirements (EHSRs):**  
İlgili Temel Sağlık ve Güvenlik Gereklilikleri [10]. bölümde belirtilen standartlara göre sağlanmıştır.  
*The relevant EHSRs are covered by the standard mentioned in [10], according which the product was verified and in the manufacturer's instruction for use.*

[20] **Dokümantasyon Listesi / List of Documentation:**

Çizim No/ Drawing No:	Sayfa Sayısı # of page	Rev	Tarih/ Date	Adı/ Name
-	4	-	20.10.2021	Kısa Exproof Etanj taban / Ürün/ Cam/ Sac / Drawings (Short model)
-	5	-	01.04.2021	Uzun Exproof Etanj Sac/Taban / Cam / Ürün / Elektrik Bağlantı Şeması / Drawing(long)
-	13	-	-	Teknik Dosya / Technical File

Bu belge sadece tamamını içerecek şekilde ve hiçbir değişiklik yapılmadan ekiyle birlikte çoğaltılabilir.  
*This certificate and its schedules may only be reproduced in its entirety and without any change.*

Veriliş Tarihi/ Date of issue: 28.12.2021

[www.tse.org.tr](http://www.tse.org.tr) / Necatibey Cad. No: 112 Bakanlıklar - ANKARA / +90 312 416 62 00 Sayfa/Page 2 / 2  
*This certificate cannot be altered, partially duplicated or copied for misunderstanding.*



Ireland, Avalon Atrium Project



Lebanon, ABC Verdun Shopping Mall



Ireland, Consensys Fit Out Project



Türkiye, Ankara METU Infant School Project



Albania, Qendra Tregtare Univers Shopping Mall



Serbia, Supermarket Veroks Project



Türkiye, Ankara Özgata Medical Materials Pharmaceutical Industry Office



Oman, Oasis Mall Sohar





Türkiye, Bursa Koç Dialysis



Türkiye, Konya Public Library



Türkiye, Ankara Disaster Coordination Center



Egypt, Cairo Bank Misr



Türkiye, Kahramanmaraş Dorutech



Ireland, Micheal Tierney Building

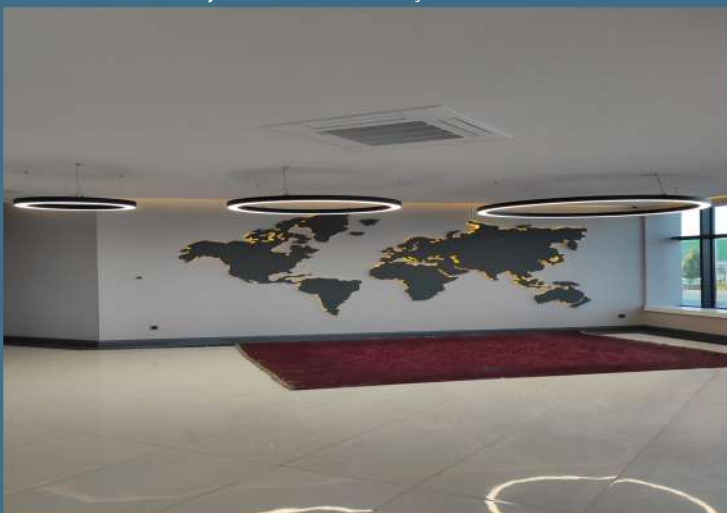

Türkiye, Gaziantep Vista Carpet



Türkiye, Çumra Torku Doğrudan Market



**Head Office Factory / Direction Generale Usine**

**Fetih Mah. Seyhulema Recepaga Cad. No: 262 42030 Karatay - Konya / TURKIYE**

**T: +90 332 355 86 16 - F: +90 332 355 86 12**

**E-mail: [pamir@pamir.com.tr](mailto:pamir@pamir.com.tr) - [www.pamir.com.tr](http://www.pamir.com.tr)**

 [/pamir\\_lighting](https://www.instagram.com/pamir_lighting)

 [/PamirLighting](https://twitter.com/PamirLighting)

 [/pamirlightingfixtures](https://www.facebook.com/pamirlightingfixtures)